

FATAL

FURY™

Dreamcast™



餓狼

FATAL FURY

MARK OF THE WOLVES™

SNK

agetec™



T-44306N

WARNINGS Read Before Using Your Sega Dreamcast Video Game System

CAUTION

Anyone who uses the Sega Dreamcast should read the operating manual for the software and console before operating them. A responsible adult should read these manuals together with any minors who will use the Sega Dreamcast before the minor uses it.

HEALTH AND EPILEPSY WARNING

Some small number of people are susceptible to epileptic seizures or loss of consciousness when exposed to certain flashing lights or light patterns that they encounter in everyday life, such as those in certain television images or video games. These seizures or loss of consciousness may occur even if the person has never had an epileptic seizure.

If you or anyone in your family has ever had symptoms related to epilepsy when exposed to flashing lights, consult your doctor prior to using Sega Dreamcast.

In all cases, parents should monitor the use of video games by their children. If any player experiences dizziness, blurred vision, eye or muscle twitches, loss of consciousness, disorientation, any involuntary movement or convulsion, **IMMEDIATELY DISCONTINUE USE AND CONSULT YOUR DOCTOR BEFORE RESUMING PLAY.**

To reduce the possibility of such symptoms, the operator must follow these safety precautions at all times when using Sega Dreamcast:

- Sit a minimum of 6.5 feet away from the television screen. This should be as far as the length of the controller cable.
- Do not play if you are tired or have not had much sleep.
- Make sure that the room in which you are playing has all the lights on and is well lit.
- Stop playing video games for at least ten to twenty minutes per hour. This will rest your eyes, neck, arms and fingers so that you can continue comfortably playing the game in the future.

OPERATING PRECAUTIONS

To prevent personal injury, property damage or malfunction:

- Before removing disc, be sure it has stopped spinning.
- The Sega Dreamcast GD-ROM disc is intended for use exclusively on the Sega Dreamcast video game system. Do not use this disc in anything other than a Sega Dreamcast console, especially not in a CD player.
- Do not allow fingerprints or dirt on either side of the disc.
- Avoid bending the disc. Do not touch, smudge or scratch its surface.
- Do not modify or enlarge the center hole of the disc or use a disc that is cracked, modified or repaired with adhesive tape.
- Do not write on or apply anything to either side of the disc.
- Store the disc in its original case and do not expose it to high temperature and humidity.
- Do not leave the disc in direct sunlight or near a radiator or other source of heat.
- Use lens cleaner and a soft dry cloth to clean disc, wiping gently from the center to the edge. Never use chemicals such as benzene and paint thinner to clean disc.

PROJECTION TELEVISION WARNING

Still pictures or images may cause permanent picture tube damage or mark the phosphor of the CRT. Avoid repeated or extended use of video games on large-screen projection televisions.

SEGA DREAMCAST VIDEO GAME USE

This GD-ROM can only be used with the Sega Dreamcast video game system. Do not attempt to play this GD-ROM on any other CD player; doing so may damage the headphones and/or speakers. This game is licensed for home play on the Sega Dreamcast video game system only. Unauthorized copying, reproduction, rental, public performance of this game is a violation of applicable laws. The characters and events portrayed in this game are purely fictional. Any similarity to other persons, living or dead, is purely coincidental.



Thank you for purchasing
Fatal Fury: Mark of the
Wolves™. Please note that
this software is designed
only for use with the Sega
Dreamcast console. Be sure
to read this instruction
manual thoroughly before
playing Fatal Fury: Mark of
the Wolves™.

CONTENTS

HARDWARE / CONTROLLER / PERIPHERAL INFORMATION	02
GAME MODES	04
GAME SCREEN	05
GAME CONTROLS	06
STORY MODE	07
Visual Memory Unit (VMU)	08
SURVIVAL MODE	09
PRACTICE MODE	10
GALLERY MODE	11
OPTION MENU	12
SUPER MOVES & HIDDEN ABILITIES	12
T.O.P. SYSTEM	13
JUST DEFENDED	14
BREAKING	15
CHARACTERS & SPECIAL MOVES	16

HARDWARE / CONTROLLER / PERIPHERAL INFORMATION

The following section covers information pertaining to the setup and use of the Sega Dreamcast Hardware Unit, Controllers and Peripherals.

*To return to the title screen at any point during game play, simultaneously press and hold the A, B, X, Y and the START buttons. This will cause the Sega Dreamcast to soft-reset the software.

SEGA DREAMCAST HARDWARE UNIT

* Fatal Fury: Mark of the Wolves is a 1-2 player game. Before turning the Sega Dreamcast power ON, connect the controller or other peripheral equipment into the control ports of the Sega Dreamcast.

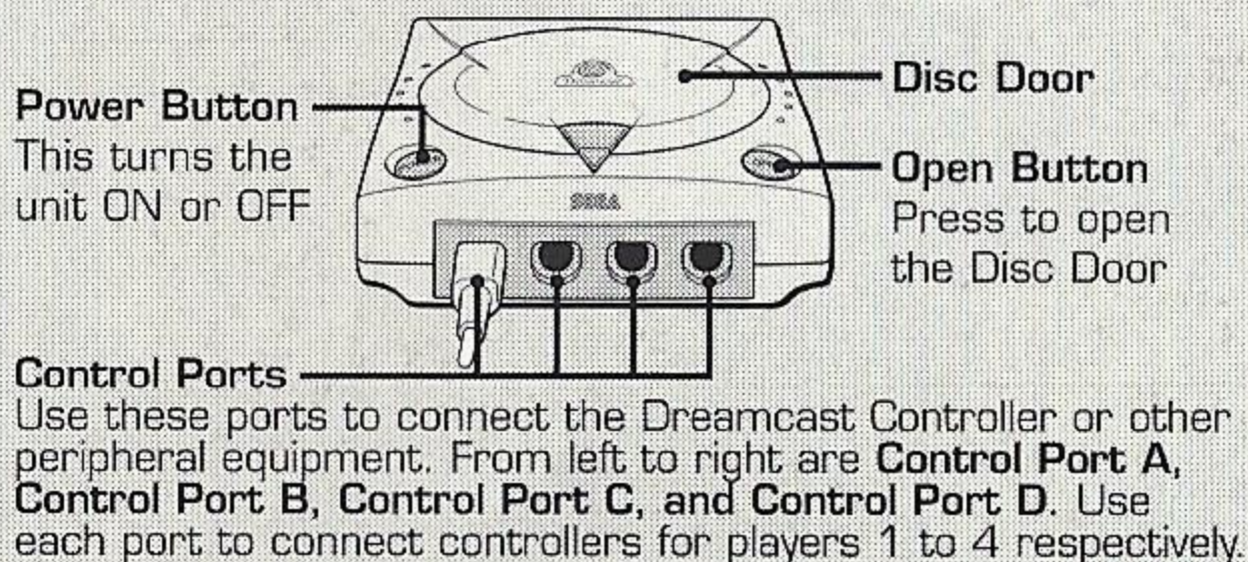

SEGA DREAMCAST CONTROLLER

OVERHEAD VIEW

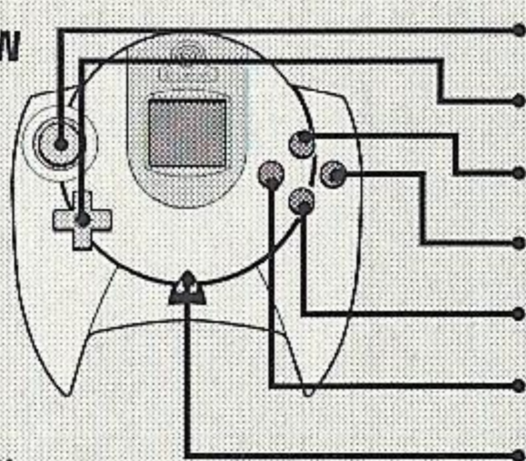

Analog Thumb Pad

Not used

Directional Button (D-Button)

Highlight menu selections/Control character movements

Y Button

Strong Punch

B Button

Cancel menu selections/Strong Kick

A Button

Confirm menu selections/Light Kick

X Button

Light Punch

Start Button

Confirm menu selections/Start game/Pause game

FORWARD VIEW

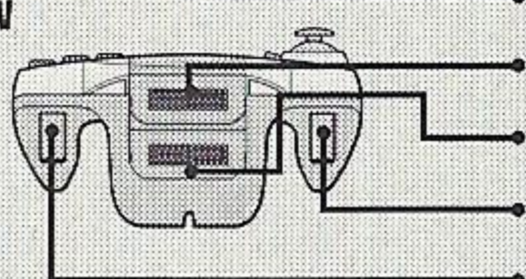

Expansion Socket 1

Insert Visual Memory Unit-VMU (sold separately)

Expansion Socket 2

Insert Jump Pack (sold separately)

L Trigger

Taunt

R Trigger

Light Punch + Light Kick (Breaking)

* A second controller (sold separately) is required for 2-player matches.

* The button functions described above are the default settings. Access the PAD CONFIGURATION menu to make changes to the default settings.

* Never touch the Analog Thumb Pad or the Triggers L/R while turning the Sega Dreamcast power ON. Doing so may disrupt the controller initialization procedure and result in malfunction.

* If the Analog Thumb Pad or Triggers L/R are accidentally moved while turning the Sega Dreamcast power ON, immediately turn the power OFF and then ON again making sure not to touch the controller.

Sega Dreamcast Arcade Stick (sold separately)

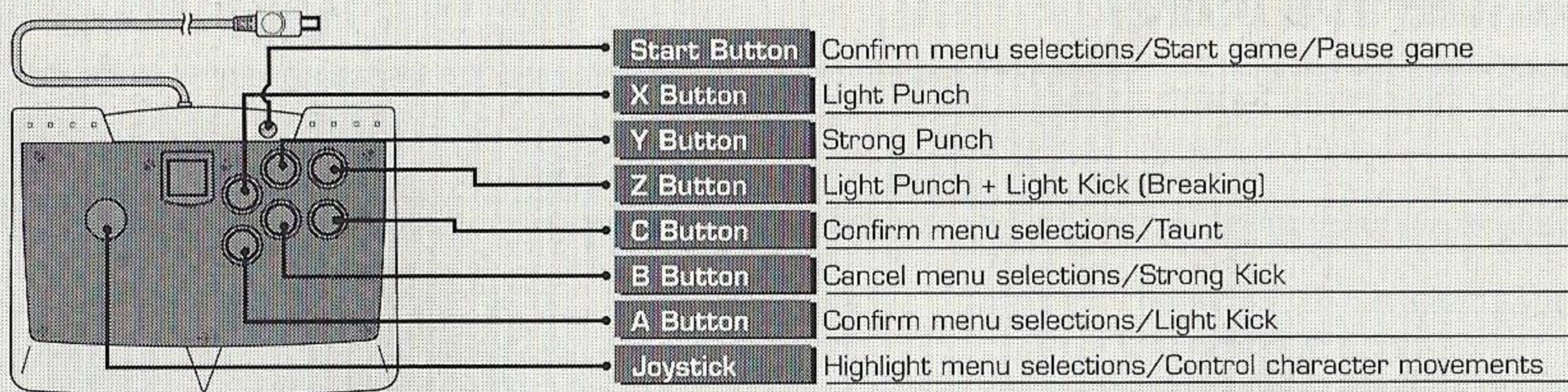

Sega Dreamcast Jump Pack™

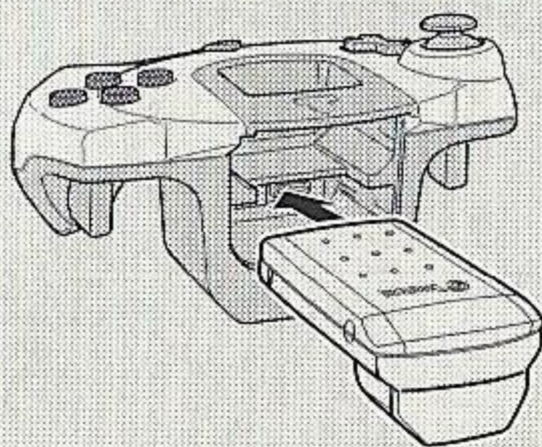

The Jump Pack should always be inserted into Expansion Socket 2.
 *When the Jump Pack is inserted into Expansion Socket 1 of the Sega Dreamcast Controller, the Jump Pack connects, but does not lock. If the controller is jarred, the Jump Pack may fall out during game play or otherwise inhibit game operation.

*To return to the title screen at any point during game play, simultaneously press and hold the A, B, X, Y and START buttons. This will cause the Sega Dreamcast to soft-reset the software.

* Be sure to refer to the Jump Pack instruction manual for proper installation procedures.

Sega Dreamcast Visual Memory Unit (VMU)

* While saving a game file, never turn OFF the Sega Dreamcast power, remove the memory card or disconnect the controller.

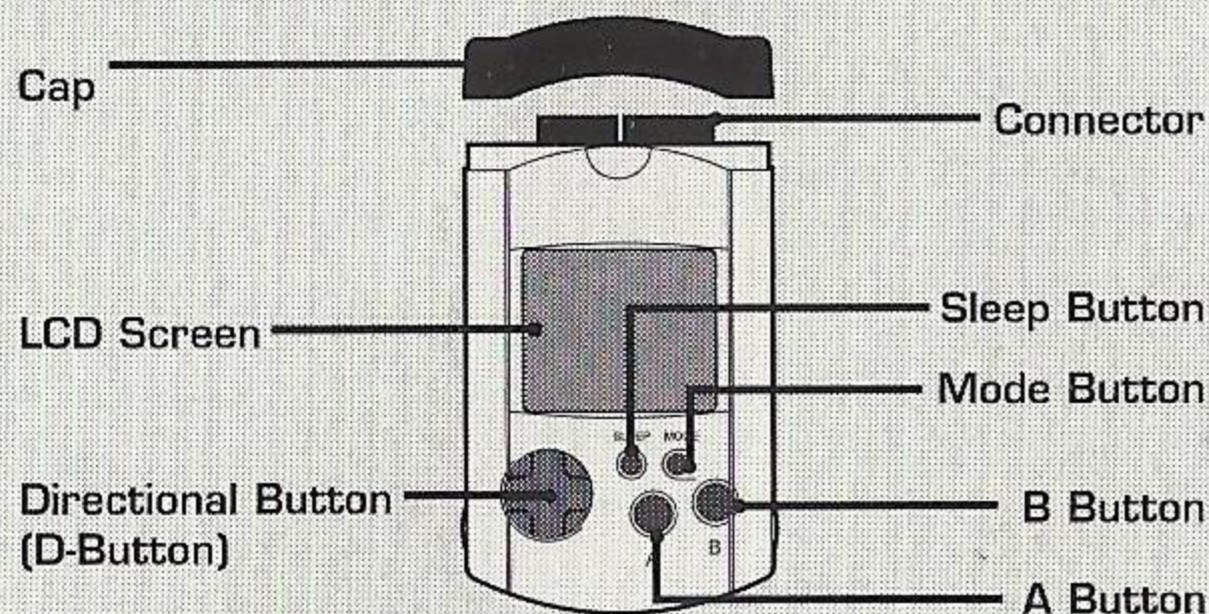

GAME MODES

Press the START button at the title screen to display the MODE SELECT screen.

Story Mode:	1P mode. Compete against CPU opponents.
Survival Mode:	1P mode. Compete against a series of CPU opponents. Hitting your opponent causes various items to appear on-screen.
VS Mode:	2P VS mode
Practice:	Utilize this mode to practice character moves and combos.
Gallery:	View a variety of game illustrations and artwork.
Option:	Access this mode to make changes to different game settings.

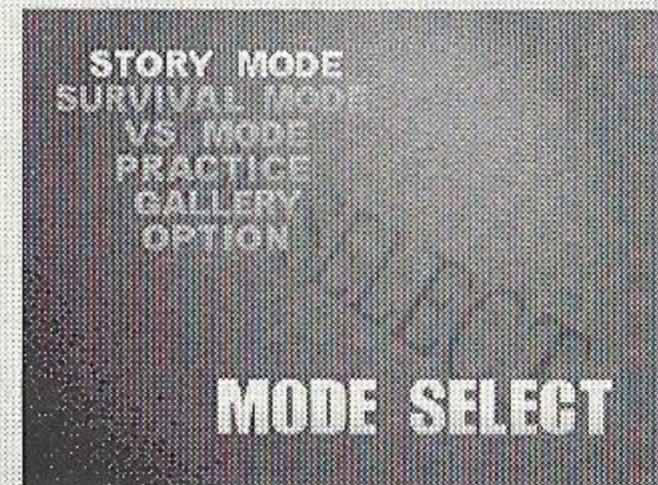

GAME SCREEN

T.O.P. Gauge

When the life gauge is reduced to the point where it intersects with the T.O.P. gauge, the T.O.P. system is activated.

Life Gauge

Represents the character's remaining life energy. A character is defeated once all of their life energy is depleted.

Character

Displays the name of the character.



Time Remaining

Displays the time left in the round. If both characters are standing when the timer reaches "0", the victor is determined by which character has the most life energy remaining in their life gauge.

Victory Mark

Indicates the number of rounds won during a match.

Power Gauge

As this gauge increases, Super Moves and Hidden Abilities become available.

GAME CONTROLS

The commands described below all assume that the character is facing to the right and that the default button settings are being used.

Basic Moves

Move Forward	⇒
Move Backward	⇐
Jump	↖ or ↑ or ↗
Crouch	↘ or ↓ or ↙
Guard	When being attacked ⇐ (standing guard) ↘ (crouching guard)
Light Punch	X
Light Kick	A
Strong Punch	Y
Strong Kick	B

Special Moves

Dash Forward	⇒⇒
Dash Backward	⇐⇐
Throw	When near opponent ⇐ or ⇒ + Y
Throw Escape	When seized ⇐ or ⇒ + Y
Before being knocked down	X (small front), A (small back), Y (big front), B (big back)
Taunt	L Trigger
Low Dodge Attack	When standing X A (simultaneously)
High Dodge Attack	When crouching X A (simultaneously)
T.O.P. Attack	Y B (simultaneously) when T.O.P. is activated
Small Jump	Tap ↑
Fake Move	⇒ + XY or ↓ + XY

STORY MODE

Story Mode

How the game's story progresses depends on the character selected. If a relationship exists between the character you've selected and a particular opponent, a special demo appears before their fight. To truly complete each character's story and reach the final fight, each character must complete the first seven fights of the game with an average ability rating of AAA or higher received at the end of each round.

Continue Service

Press the START button on the Continue screen, before the count-down reaches zero, to access the Continue Service. Once accomplished, select the desired Continue Service by pressing the button that corresponds to it. The Continue Service selected remains in effect until an opponent has been defeated. If the continue option is not selected, the current game ends and an option to save game progress is presented.

MAX Power Gauge (A)

Begin play with a full Power Gauge.

COM Difficulty Down (B)

Begin play with a decreased CPU difficulty level.

Opponent Power (X)

Begin play with opponent's life at 1/4.

No Service (Y)

Resume play without Continue Service.

Burst-In Play

Press the START button on the unused controller during STORY MODE to discontinue the 1P VS CPU battle and switch to 2P VS.



CONTINUE SERVICE

- A Power Gauge MAX
- B Difficulty Level Down
- X 1/4 Opponent Power
- Y Normal Game

THE CHALLENGER

VISUAL MEMORY UNIT (VMU)

Fatal Fury: Mark of the Wolves is Visual Memory Unit (VMU) compatible. This provides the ability to save and load game progress, preferred game settings and match results.

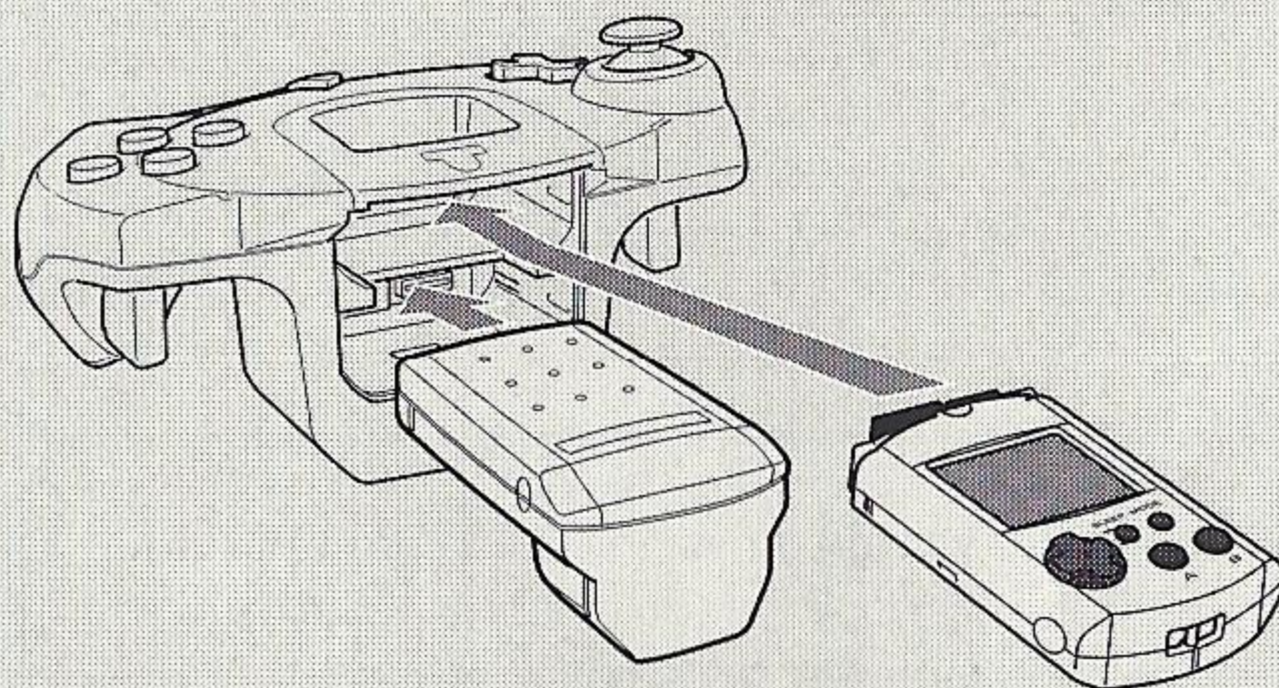

Saving & Loading

Insert the VMU into Expansion Socket 1 prior to turning the Sega Dreamcast power ON. The option to save game data appears after a game ends. Highlight the YES option using the Directional button and press the A button to access the Select Memory Card screen. Now select the controller port and expansion socket where the VMU is inserted and press the A button to confirm the selection. Confirm the Stage and System save options, by selecting YES, to finish the process. Six free memory card blocks are required to save game data.

The load option appears prior to starting a game and works in much the same way as the save option.

SURVIVAL MODE

Survival is a 1P mode consisting of 14 single-round matches. Hitting your opponent during this mode causes items to appear on-screen. Collect these items to increase the power gauge, time remaining or life gauge. Changes to the following options: Game Time, Round Set, Demo Cut and Risk have no effect in Survival mode.

- T Slightly increases the time remaining.
- P Increase the power gauge by one level.
- L Slightly increases the character's life energy.
- ☠ Random, negative status change to one of the parameters listed above.



PRACTICE MODE

This mode is ideal for polishing moves and practicing combos. Use the Directional button $\uparrow\downarrow$ to highlight options on the Option Set screen and $\leftarrow\rightarrow$ to make changes to the selected option. Press the start button at anytime during the practice mode to display the Option Set screen.

COM-ACTION 1 Set the CPU opponent's pose.

STAND	Opponent stands
JUMP	Opponent jumps
CROUCH	Opponent crouches

COM-ACTION 1 Set the CPU opponent's pose.

NO GUARD	Opponent does not guard
GUARD 1	Opponent always guards, certain attacks cannot be guarded against.
GUARD 2	Opponent does not guard against the first attack. After the first attack, the opponent reverts to the Guard 1 strategy. Combination attacks prevent the opponent from utilizing the Guard 1 strategy.
GUARD 3	Opponent's ability to guard is dependent on the COM-ACTION 1 setting.
ATTACK	Opponent always attacks

T.O.P. Adjust T.O.P. power setting

GAUGE Adjust the level of the power gauge

COUNTER When ON, all attacks that hit an opponent are considered counter hits

JUST DEFENDED Enable the opponent to use Just Defended blocks

STAGE CHANGE Change stage

CHARACTER CHANGE Change character

RETURN TO CENTER Returns the characters to their initial starting points on the stage

RETURN TO MENU Return to the mode select screen

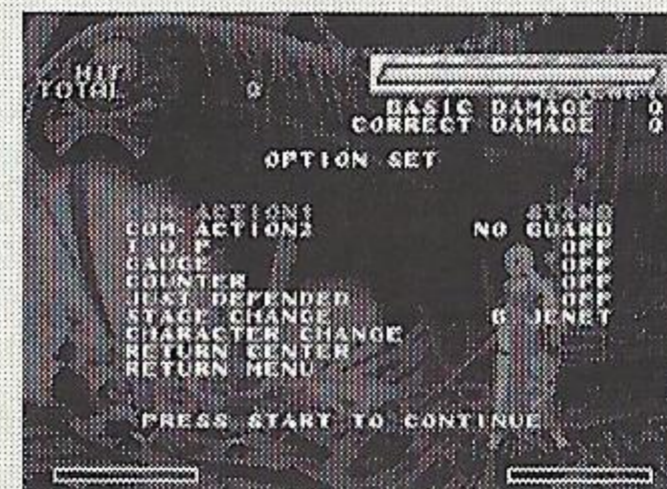

GALLERY MODE

View artwork samples from the game.
 [Character]: View character artwork.
 [Ending]: View ending artwork.
 [Art Work]: View poster illustrations.

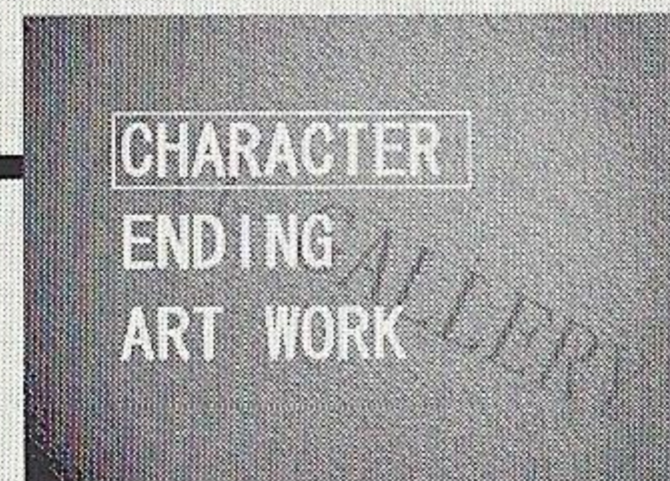

All images in the Character section are available from the beginning. Certain conditions must be met before all images in the Ending and Art Work sections are available for viewing.



Directional button	Scroll image
X button	Reduce image
Y button	Enlarge image
A button	Show/hide menu
B button	Go back
L/R trigger	Cycle through images

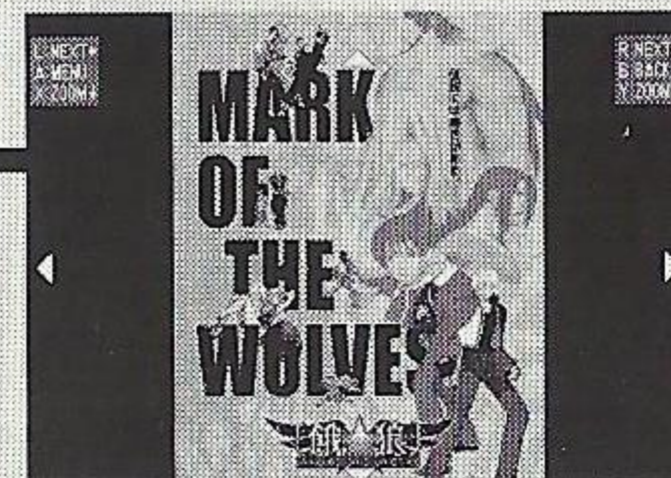

OPTION MENU

LEVEL	Set CPU difficulty level (1=easiest, 8=hardest)
GAME TIME	Change round time limit. (∞ =No time limit)
ROUND SET	Change the number of rounds required to win a match.
DEMO CUT	Choose to view or skip animated cut scenes
FLASH	Turn in-game flash displays ON/OFF
VIBRATION	Turn the vibration setting ON/OFF
RISK	Turn the VS mode handicap setting ON/OFF
SOUND	Adjust the sound setting STEREO/MONAUURAL
MUSIC	Adjust the music setting ARRANGE/ORIGINAL
PAD CONFIGURATION	Make adjustments to button functions here
EXIT	Return to the Mode Select screen



SUPER MOVES & HIDDEN ABILITIES

The meters on the bottom left and right of the game screen are called Power Gauges. These gauges can be increased a maximum of two levels by successfully attacking an opponent, using Special Moves or being attacked. The Power Gauge enables the use of the moves described below:

S POWER (1st Level)	Super Move
P POWER (2nd Level)	Hidden Ability or a double Super Move

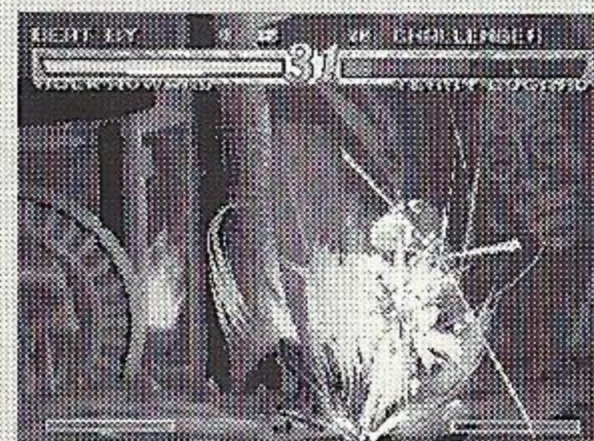

T.O.P. SYSTEM

T.O.P. Setting

After selecting a character, adjustments can be made to the T.O.P. settings. To do so, use the Directional button \leftrightarrow to determine activation timing (front/middle/back) and \updownarrow to select from three power levels. The narrower the T.O.P. gauge is, the greater the attack power.



T.O.P. Activation

When the life gauge and T.O.P. gauges intersect the character begins flashing. This indicates that the T.O.P. system is activated. While active, the following three things occur:

- 1) Attack power increases
- 2) Life gauge gradually recovers
- 3) T.O.P. attack is enabled



JUST DEFENDED

Just Defended

Successfully blocking an opponent's attack at the last possible moment (on the ground or in the air) enables the Just Defended feature, which is indicated by a blue aura that surrounds the character. When accomplished successfully, the character regains some amount of life energy (the amount depends on the type of attack that was blocked). While active, the following occurs:

- 1) Guard endurance level remains stable
- 2) Guard cancel moves are enabled



Guard Crush

Using a character's normal guard against a chain of back-to-back attacks weakens their defense and eventually causes the character to flash red. If the character remains in this state, their guard is eventually broken and they are rendered defenseless. This is known as Guard Crush.



BREAKING

Each character has the ability to cancel one of their special moves in mid-performance and link it to another move, thus enabling them to perform devastating combination attacks. This is known as Breaking.

Breaking

To do this, press the A and X buttons simultaneously when performing the character's Breaking move

EX.

Rock Howard	Evac Toss ⇒ Breaking ⇒ Raising a Storm
Terry Bogard	Power Dunk ⇒ Breaking ⇒ Buster Wolf
Khushnood Butt	Koho ⇒ Breaking ⇒ Kyokugen Koho

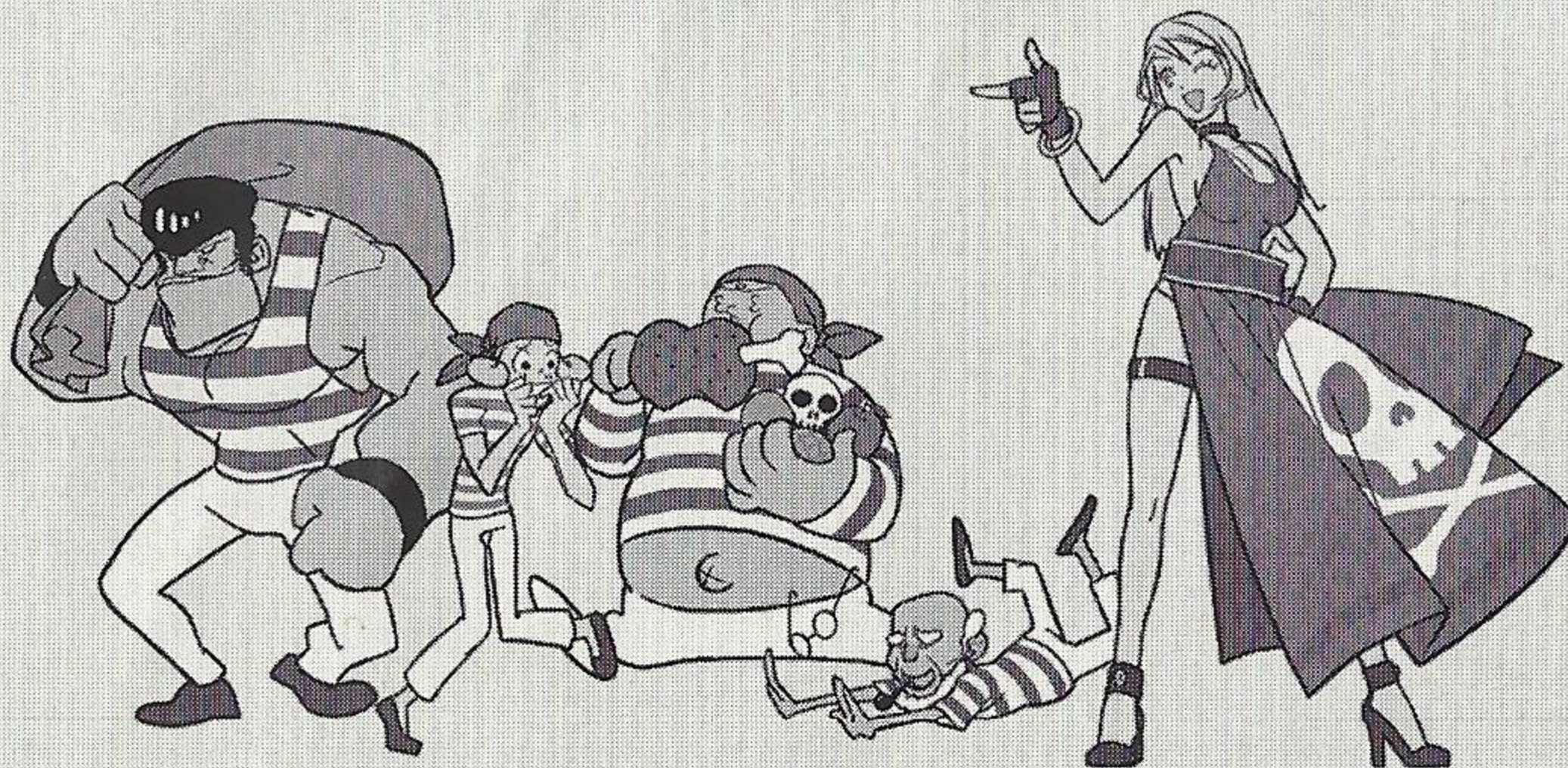

Rock Howard

The forgotten scion of Geese Howard, raised by Terry Bogard. A sensitive youth who walks the razor's edge between his principles and the reality of his lineage.

Special Moves

Cyclone Sock	↓↘⇨ + X
Double Gust Punch	↓↘⇨ + Y
Crack Counter	↓↘⇨ + A or B
Rising Tackle	↓ briefly, then ↑ + X or Y
Hard Edge	↓↘⇨ + X or Y
Rage Run	↓↘⇨ + A or B
*Evac Toss	Near opponent rotate Directional button once + Y

*Breaking Move

Super Moves

Raising a Storm	↓↘⇨↓↘⇨ + Y (Power-build enabled)
Shining Knuckles	↓↘⇨↓↘⇨ + A

Hidden Abilities

Raising a Storm	↓↘⇨↓↘⇨ + Y
Shining Knuckles	↓↘⇨↓↘⇨ + B
Deadly Rave Neo	⇨↘ ↓↘⇨⇨ + X then X X A A Y Y B B ↓↘⇨ + Y



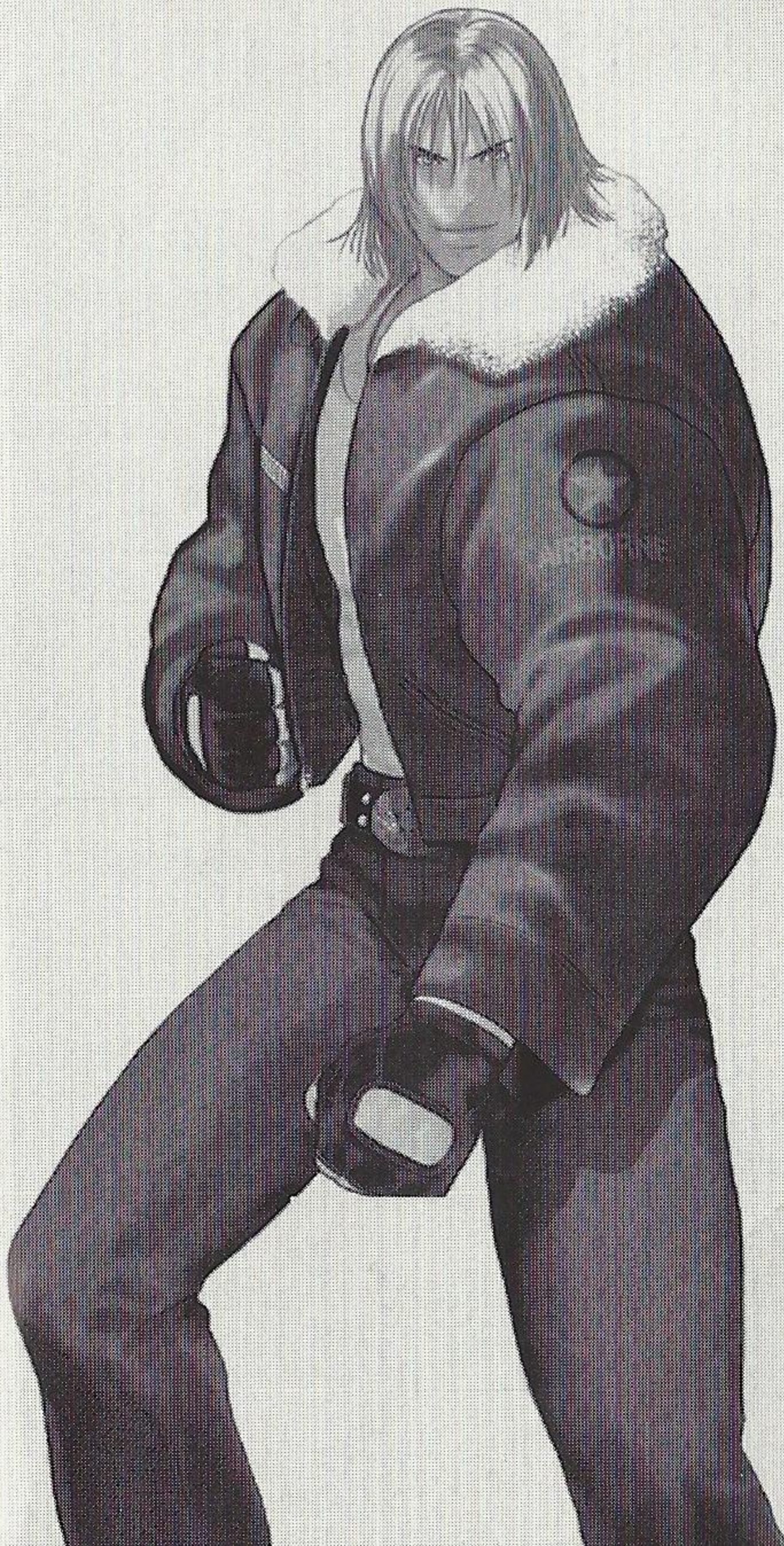

Terry Bogard

The returning "Legendary Wolf." He now travels with Rock, improving his skills in tournaments throughout the world.

Special Moves

Power Wave	↓↘↙ + X or Y
Burning Knuckles	↓↘↙ + X or Y
* Power Dunk	↔↓↘ + A or B
Crack Shoot	↓↘↙ + A or B
Power Charger	↔↔ + X or Y repeat 3 times

*Breaking Move

Super Moves

Power Geyser	↓↘↙↓↘↙ + X
Buster Wolf	↓↘↙↓↘↙ + A

Hidden Abilities

Power Geyser	↓↘↙↓↘↙ + Y
Buster Wolf	↓↘↙↓↘↙ + B

Kim Dong Hwan

The first-born son of Kim Kap Hwan, Servant of Justice. Unlike his father, Dong Hwan is a devil-may-care rake with a genius for tae kwon do.

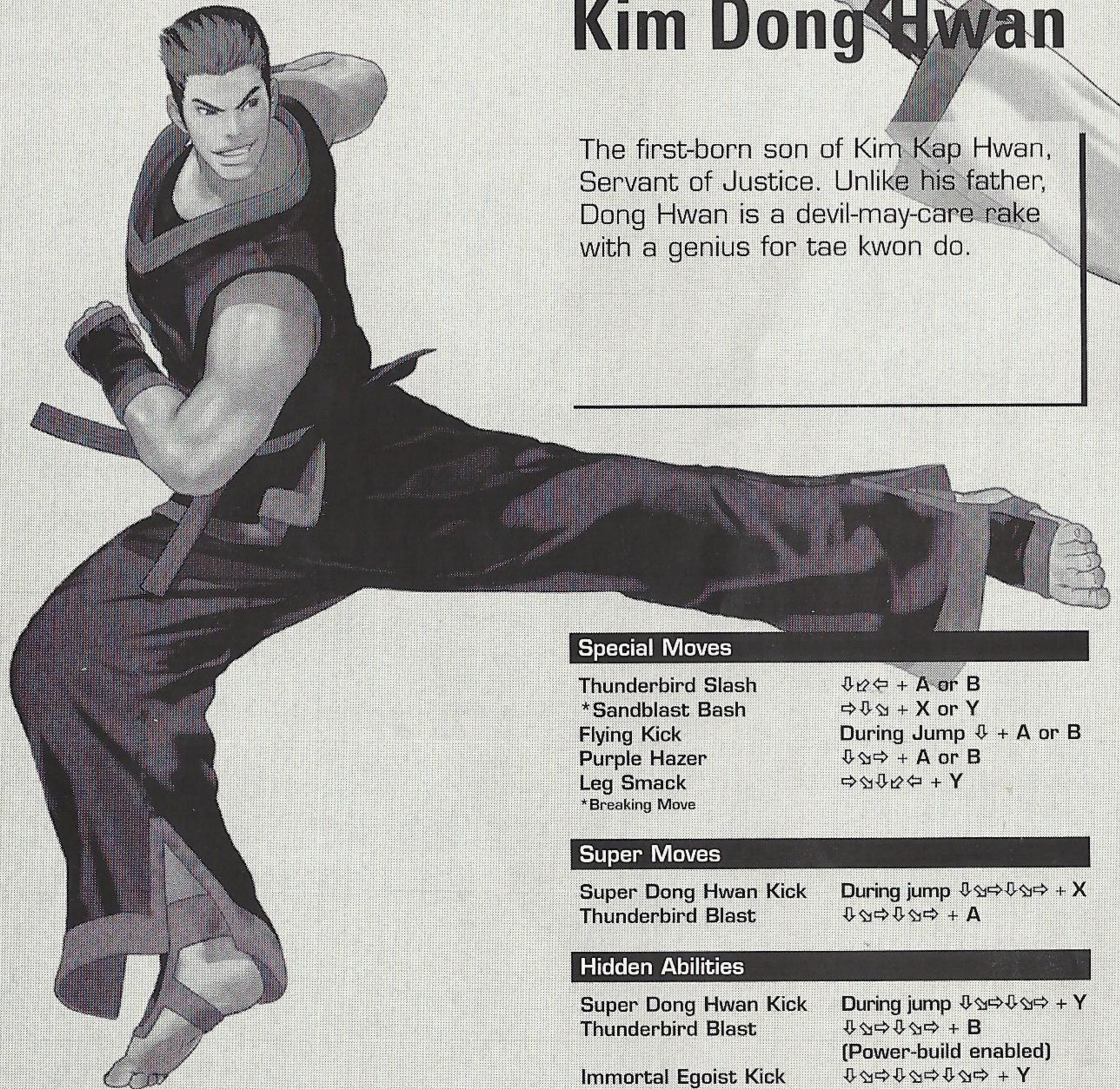

Special Moves

Thunderbird Slash	↓↘↙ + A or B
*Sandblast Bash	↔↓↘ + X or Y
Flying Kick	During Jump ↓ + A or B
Purple Hazer	↓↘↔ + A or B
Leg Smack	↔↘↓↘↔ + Y
*Breaking Move	

Super Moves

Super Dong Hwan Kick	During jump ↓↘↔↓↘↔ + X
Thunderbird Blast	↓↘↔↓↘↔ + A

Hidden Abilities

Super Dong Hwan Kick	During jump ↓↘↔↓↘↔ + Y
Thunderbird Blast	↓↘↔↓↘↔ + B (Power-build enabled)
Immortal Egoist Kick	↓↘↔↓↘↔↓↘↔ + Y

Kim Jae Hoon

Second born of Kim Kap Hwan, Servant of Justice. Following in his father's footsteps, he participates in tournaments to prove the prowess of tae kwon do.

Special Moves

* Steam Stab	↓ briefly, then ↑ + A or B
Crescent Moon Slash	↓↘↙ + A or B
Flying Kick	During jump ↓ + A or B
Comet Cruncher	↓↘↙ + A or B
Molten Attack	↓↘↙ + X or Y (Power-build enabled)

*Breaking Move

Super Moves

Phoenix Wing Womper	↓↘↙↓↘↙ + X
Phoenix Flattener	↓↘↙↓↘↙ + A

Hidden Abilities

Phoenix Wing Womper	↓↘↙↓↘↙ + Y
Phoenix Flattener	↓↘↙↓↘↙ + B

Hotaru Futaba

A courageous young maid who faces the vagaries of life with a cheerful pluck. After the death of her mother, she set out to search for her missing older brother with her trusty pet, Eetto.

Special Moves

Spirit Slam	↓↘⇨ + X or Y
Combo Kick	During jump ↓↘⇨ + A or B
Twisting Flight	⇨↓↘ + A or B
Double Blow Onslaught	↓↘⇨ + X or Y
Lunging Thigh	⇨↘↓↘⇨ + B
*Tiger Tail Kick	↓↘⇨ + A or B
*Breaking Move	

Super Moves

Lotus Land Punch	↓↘⇨↓↘⇨ + X
Flying Queen of Chaos	↓↘⇨↓↘⇨ + A

Hidden Abilities

Lotus Land Punch	↓↘⇨↓↘⇨ + Y
Flying Queen of Chaos	↓↘⇨↓↘⇨ + B

Gato

The solitary rebel. He pursues the power to defeat the father who drove Gato's beloved mother to death. What he hopes to find is the ultimate technique in martial arts.

Special Moves

Quaking Fang	↓↘⇒ + X or Y
*Lightning Fang	⇒↓↘ + A or B
Wind Fang	↓↘⇐ + A or B
Arrow Fang	During Wind Fang X
Smooth Fang	During Wind Fang A
Avalanche Crunch Fang	↓ briefly, then ↑ + Y
*Breaking Move	

Super Moves

Freeze Fang	↓↘⇒↓↘⇒ + X
Dragon Fang	↓↘⇒↓↘⇒ + A

Hidden Abilities

Freeze Fang	↓↘⇒↓↘⇒ + Y
Dragon Fang	↓↘⇒↓↘⇒ + B
Flaming Serpent's Fang	⇒↓↘ + XA (Repeat 3 times)

Hokutomaru

Deep in a mountain recess, this ninja tyke trains in the Shiranui ninja arts. To put the fruits of his trials to use, he has stolen out of his mountain hideaway to enter the tournament.



Special Moves

Human Mower	↓↘↙ + X or Y
Falling Slash	↓↘↙ + A or B (Can be performed in the air)
*Sonic Blast	↓↘↙ + A or B
Dirks	↓↘↙ + X or Y
Aerial Dirks	During jump ↓↘↙ + X or Y
*Breaking Move	

Super Moves

Super Killer Dirks	↓↘↙↓↘↙ + X
Secret Deadly Tornado	↓↘↙↓↘↙ + A

Hidden Abilities

Flaming Lament	↓↘↙↓↘↙ + Y
Ultimate Hidden Imbrogio	↓↘↙↓↘↙ + B

B. Jenet

With a penchant for thrills and excitement, Jenet loves to strike terror in the heart of bourgeois sensibility. Leader of the chivalrous brigand band the "Reeling Knights", Jenet has set her sights on the riches of the tournament's sponsor.

Special Moves

Crazy Ivan	↓↘↙ + X or Y
Gulf Tomahawk	↓↘↙ + A or B
*The Hind	↓↘↙ + A or B
Buffrass	↓↘↙ + X or Y
Harrier Bee	During jump ↓ + A or B (tap repeatedly)

*Breaking Move

Super Moves

Many Many Torpedoes	↓↘↙↓↘↙ + X
Aurora	↓↘↙↓↘↙ + A

Hidden Abilities

Many Many Torpedoes	↓↘↙↓↘↙ + Y
Aurora	↓↘↙↓↘↙ + B

Tizoc

"Skinned to the bone, but not down for the count." This formerly famous hero has assumed a mantle of adversity tempered with love, rage, and sadness to recover his stolen glory and pride.

Special Moves

Justice Hurricane

Near opponent, rotate

Directional button once + X or Y

*Over Olympus

↙↘↔ + A or B

*Poseidon Wave

↔↙↘ + X or Y

Active Tupian

↔↙↘ + X or Y

Hercules' Heave

Near opponent ↔↙↘↙ + A

Icarus Crash

During jump ↙↘↔ + X

*Breaking Move

Super Moves

Big Fall Griffon

Near opponent rotate

Directional button twice + X

Deideros Attack

↙↘↔↙↘ + A

Hidden Abilities

Big Fall Griffon

Near opponent rotate

Directional button twice + Y

Deideros Attack

↙↘↔↙↘ + B

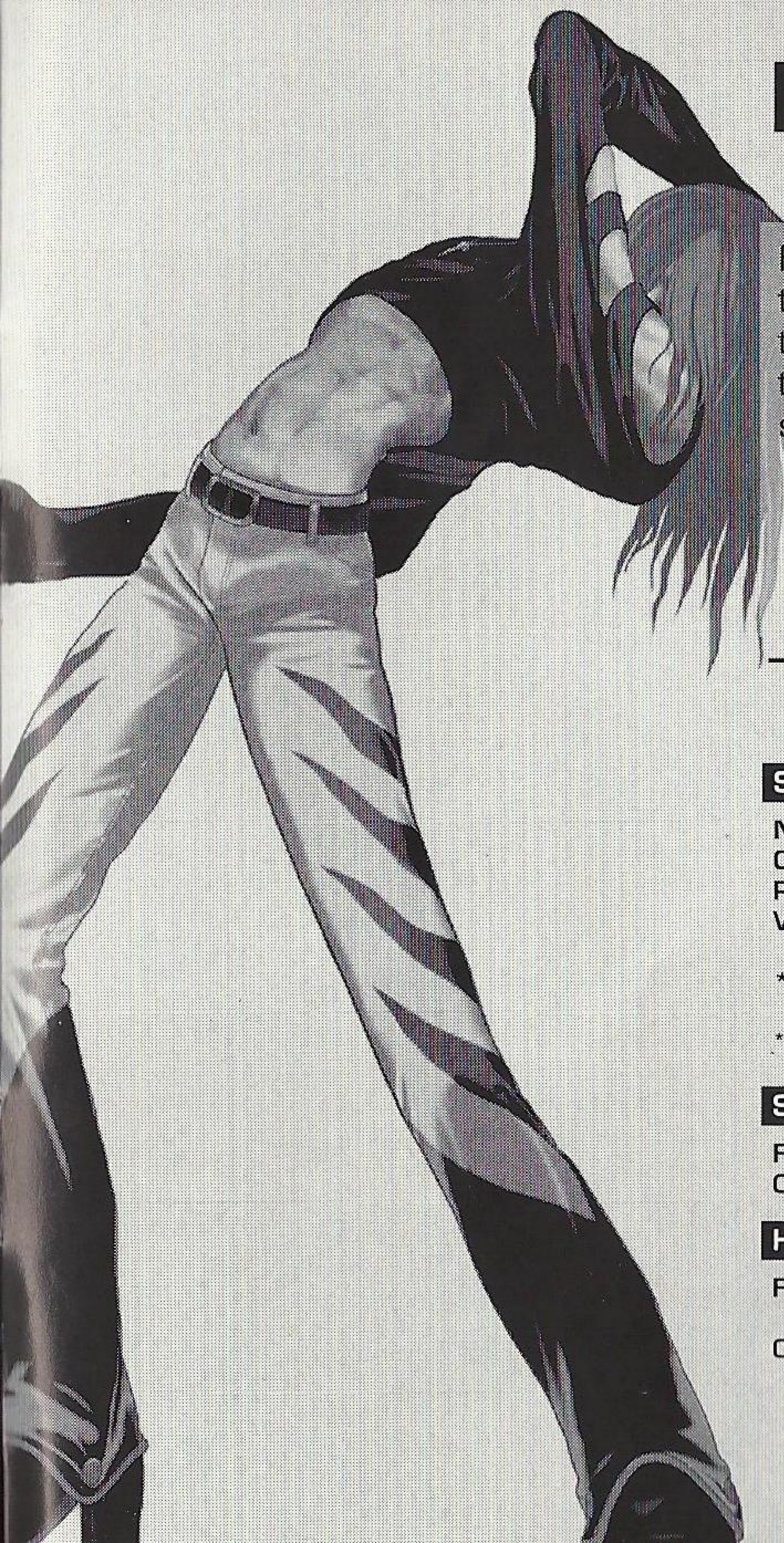

Freeman

Freeman takes to fights as a duck takes to water, believing the only way to experience life is by looking into the abyss of death. His superlative sadism always hungers for battle.

Special Moves

Nightmare	↓↘⇨ + X or Y
Crow	↓⇨⇨ + A or B
Phobia	⇨↓↘ + X or Y
V.O.D.	↓⇨⇨ + X or Y (repeat 3 times)
*Morbid Angel	⇨⇨↓↘⇨ + A or B (Power-build enabled)

*Breaking Move

Super Moves

Full Blast	↓↘⇨↓↘⇨ + X
Creeping Death	↓↘⇨↓↘⇨ + A

Hidden Abilities

Full Blast	↓↘⇨↓↘⇨ + Y (Power-build enabled)
Creeping Death	↓↘⇨↓↘⇨ + B

Khushnood Butt

The hot-fisted follower of Kyokugen karate. His will, tempered by rigorous training, is nothing to trifle with. Khushnood's mental discipline is the essence of his strength.

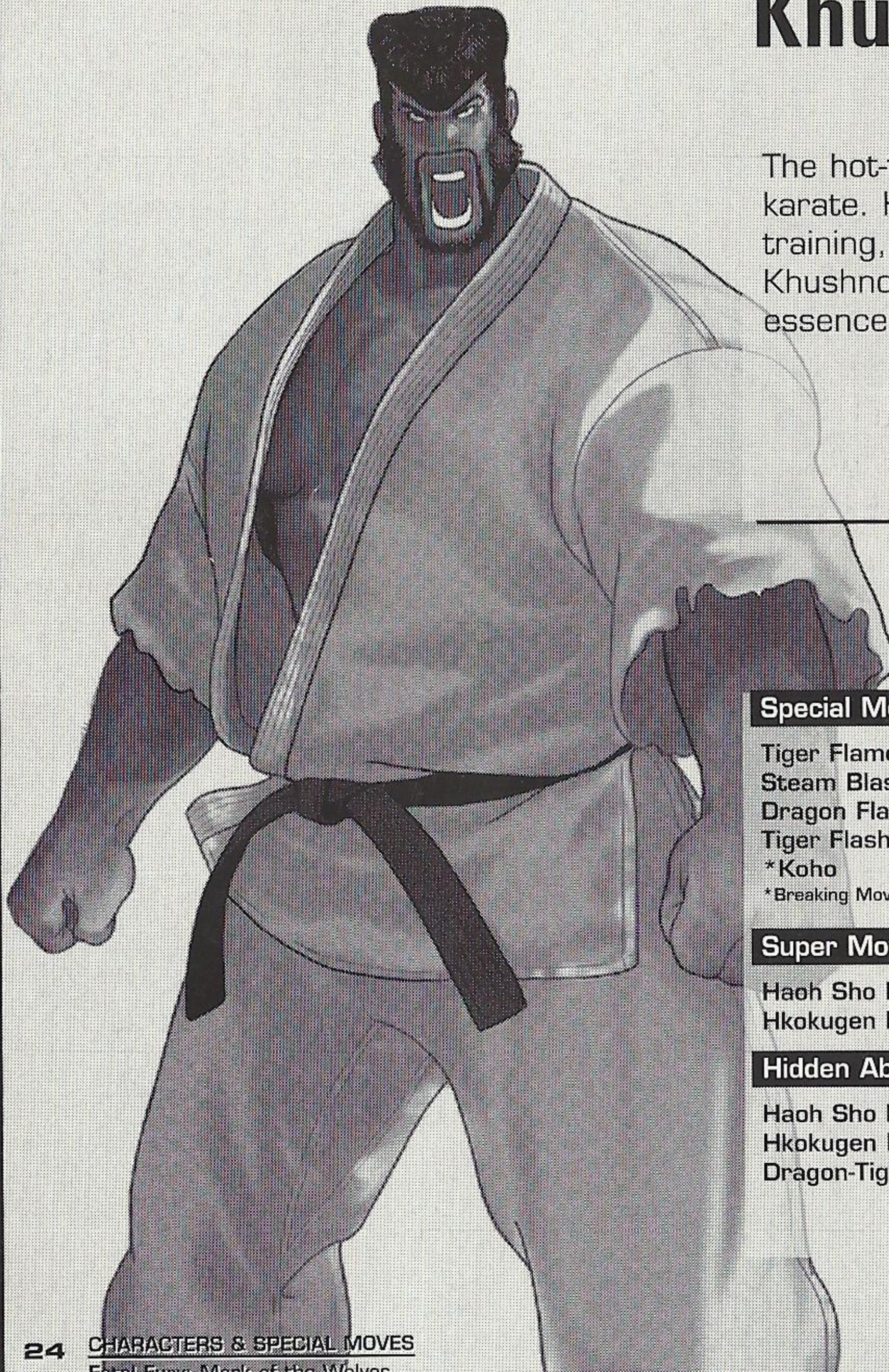

Special Moves

Tiger Flame Punch	↓↘⇒ + X or Y
Steam Blast Kick	↓↘⇒ + A or B
Dragon Flash Upper	Push down Y, release
Tiger Flash Kick	Push down B, release
*Koho	⇒↓↘ + X or Y
*Breaking Move	

Super Moves

Haoh Sho Kho Ken	↓↘⇒↓↘⇒ + X
Hkokugen Koho	↓↘⇒↓↘⇒ + A

Hidden Abilities

Haoh Sho Kho Ken	↓↘⇒↓↘⇒ + Y
Hkokugen Koho	↓↘⇒↓↘⇒ + B
Dragon-Tiger Fandango	↓↘⇒↓↘⇒↓↘⇒ + Y (tap repeatedly)

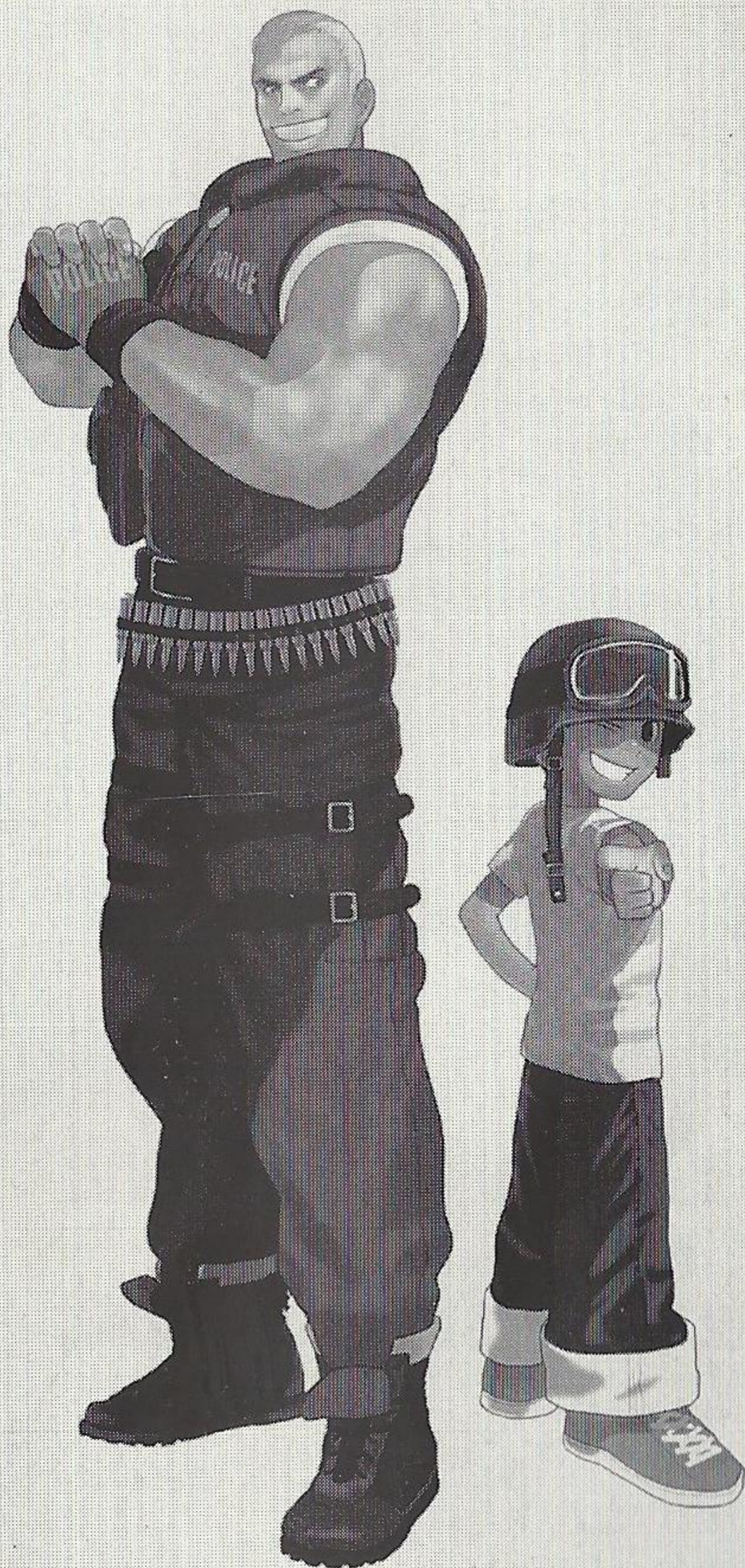

Kevin Rian

To avenge his slain friend, this chaotic copper continues his quest accompanied by the son of his dead partner. He enters the tournament armed with terrible techniques from his S.W.A.T. training.

Special Moves

Hell Rotor	↓↘↙ + X or Y (Power-build enabled) (B to cancel)
Hell Arrest	Near opponent ↙↘↓↙↘ + X or Y
*Hell Trap	↓↙↘ + A or B
Hell Snipe	↘↓↙ + X or Y
Personal Petard	↓↘↙ + B
Cleaver	↓↘↙ + A (During Cleaver X, A, or Y)

*Breaking Move

Super Moves

Lucky Strike	↓↙↘↓↙↘ + X
Gatling Freezer	↓↙↘↓↙↘ + A

Hidden Abilities

Lucky Strike	↓↙↘↓↙↘ + Y
Gatling Freezer	↓↙↘↓↙↘ + B

Grant



A sorcerer who loves a scintillating slugfest. Grant is feared as a harbinger of Armageddon who has sold his soul to the devil and put his acquired powers to destroy all who stand in his way.

Special Moves

Ebony Flame Wave	↓↘↙ + X or Y
*Raven Razor	⇒↓↘ + X or Y (During *Raven Razor ↓ + A or B)
Malevolent Munitions	↓↘⇒ + A or B
Steel Cutter Shock	⇒⇐⇒ + X or Y
Soaring Immolation	During jump ↓ + A or B
*Breaking Move	

Super Moves

Satan's Rage	↓↘⇒↓↘⇒ + X
Satan's Saw	↓↘⇒↓↘⇒ + A

Hidden Abilities

Satan's Rage	↓↘⇒↓↘⇒ + Y
Satan's Saw	↓↘⇒↓↘⇒ + B

Kain R. Heinlein



This wily kingpin endeavors to place the free city of Second Southtown in his grip and create a world in which only the truly strong survive.

Special Moves

Schwarz Flame	⇐ briefly, then ⇒ + X or Y
Schwarz Panzer	⇐ briefly, then ⇒ + A or B
*Schwarz Recht	↓ briefly, then ↑ + A or B
*Breaking Move	

Super Moves

Himmlisch Arten	↓↘⇒↓↘⇒ + X
Himmkisch Macht	↓↘⇒↓↘⇒ + A

Hidden Abilities

Himmlisch Arten	↓↘⇒↓↘⇒ + Y
Himmkisch Macht	↓↘⇒↓↘⇒ + B

Agetec, Inc. Limited WARRANTY - Software

Agetec, Inc. warrants to the original purchaser of this Agetec, Inc. production that the medium on which this software program is recorded is free from defects in materials and workmanship for a period of ninety (90) days from the date of purchase. Agetec, Inc. agrees for a period of ninety (90) days to either repair or replace, at its option, the Agetec, Inc. product.

You must call **(408)736-8001** to receive instructions to obtain repair/replacement services.

This warranty shall not be applicable and shall be void if the defect in the Agetec, Inc. product has arisen through abuse, unreasonable use, mistreatment or neglect. THIS WARRANTY IS IN LIEU OF ALL OTHER WARRANTIES AND NO OTHER REPRESENTATIONS OR CLAIMS OF ANY NATURE SHALL BE BINDING ON OR OBLIGATE AGETEC, INC. ANY IMPLIED WARRANTIES APPLICABLE TO THIS SOFTWARE PRODUCT, INCLUDING WARRANTIES OF MERCHANTABILITY AND FITNESS FOR A PARTICULAR PURPOSE, ARE LIMITED TO THE NINETY (90) DAYS PERIOD DESCRIBED ABOVE. IN NO EVENT WILL AGETEC, INC BE LIABLE FOR INCIDENTAL OR CONSEQUENTIAL DAMAGES RESULTING FROM POSSESSION, USE, OR MALFUNCTION OF THE AGETEC, INC. SOFTWARE PRODUCT.

Some states do not allow limitations as to how long an implied warranty lasts and/or exclusions or limitations of consequential damages, so the able limitations and/or exclusions of liability may not apply to you. This warranty gives you specific legal rights, and you may also have other rights which vary from state to state.

For questions and information



www.agetec.com

Repair/Service after Expiration of Warranty -- If your game disc requires repair after expiration of the 90-day Limited Warranty Period, you may contact the Consumer Service Department at the number listed below. You will be advised of the estimated cost of repair and the shipping instructions.

Agetec, Inc. Customer Service Department/Technical Support Line (408)736-8001 -- Call this number for help in installing or operating our products or for general product questions. Representatives are available Monday-Friday, 8:30am-4pm Pacific Time.

Agetec, Inc. Online at <http://www.agetec.com> -- Our news is always cool! Visit our website and find out what's happening at Agetec, Inc. - new titles, new products, and fresh tidbits about the new gaming world!

ESRB RATING

This product has been rated by the Entertainment Software Rating Board. For information about the ESRB rating, or to comment about the appropriateness of the rating, please contact the ESRB at 1-800-771-3772.

Sega is registered in the US Patent and Trademark Office. Sega, Dreamcast and the Dreamcast logo are either registered trademarks or trademarks of Sega Corporation. All Rights Reserved. Made and printed in the USA. WARNING: Operates only with NTSC televisions and Sega Dreamcast systems purchased in North and South America (except Argentina, Paraguay and Uruguay). Will not operate with any other televisions or Sega Dreamcast systems. Product covered under one or more of the following U.S. Patents: 5,460,374; 5,525,770; 5,627,895; 5,688,173; 4,442,486; 4,454,594; 4,462,076; Re. 35,839; Japanese Patent No.2870538, (Patents pending in U.S. and other countries); Canada Patent No. 1,183,276. The ratings icon is a trademark of the Interactive Digital Software Association. Sega of America Dreamcast, Inc, P.O. Box 7639, San Francisco, CA 94120.

SEGA®

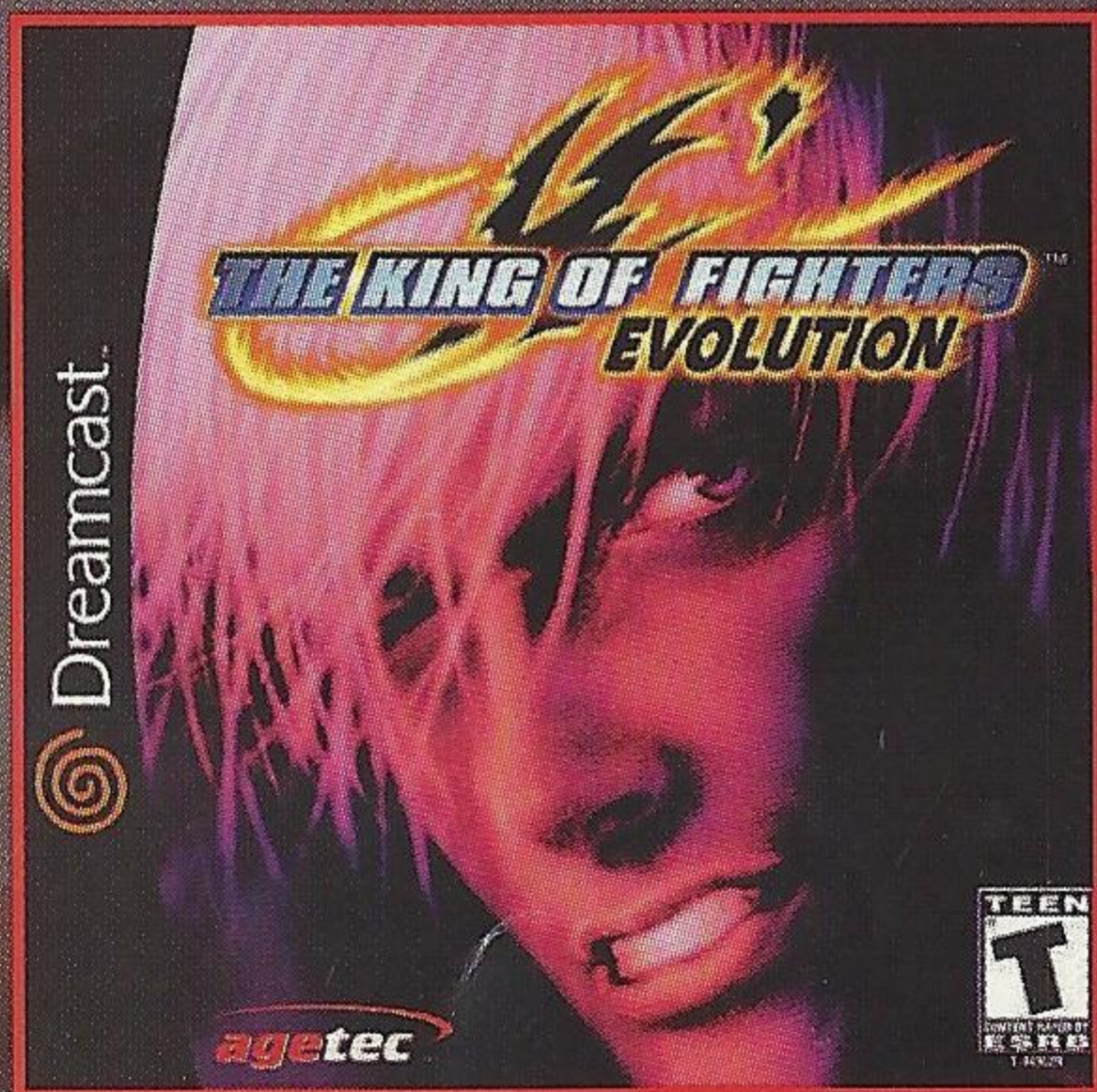

Look for these other exciting titles from Agetec for the Sega Dreamcast™ game console!



© 2000, 2001 SNK Corporation. Distributed under license by Agetec, Inc. THE KING OF FIGHTERS and THE KING OF FIGHTERS logo are trademarks of SNK Corporation. SNK and the SNK logo are trademarks of SNK Corporation.

© 1998, 2001 SNK Corporation. Distributed under license by Agetec, Inc. THE LAST BLADE 2 and THE LAST BLADE 2 logo are trademarks of SNK Corporation. SNK and the SNK logo are trademarks of SNK Corporation. Agetec and the Agetec logos are trademarks of Agetec, Inc.

Sega is registered in the US Patent and Trademark Office. Sega, Dreamcast and the Dreamcast logo are either registered trademarks or trademarks of Sega Corporation. All Rights Reserved. Made and printed in the USA. WARNING: Operates only with NTSC televisions and Sega Dreamcast systems purchased in North and South America (except Argentina, Paraguay and Uruguay). Will not operate with any other televisions or Sega Dreamcast systems. Product covered under one or more of the following U.S. Patents: 5,460,374; 5,525,770; 5,627,895; 5,688,173; 4,442,486; 4,454,594; 4,462,076; Re. 35,839; Japanese Patent No.2870538, (Patents pending in U.S. and other countries); Canada Patent No. 1,183,276. The ratings icon is a trademark of the Interactive Digital Software Association. Sega of America Dreamcast, Inc. P.O. Box 7639, San Francisco, CA 94120.

SNK

agetec

TM

SEGA