

1ST PRINTING Jan '03

SEGA®



A Redemption Game

Owner's Manual



SEGA AMUSEMENTS USA, INC.

MANUAL NO. 999-1618

VISIT OUR WEBSITE!

Back Forward Stop Refresh Home AutoFill Print Mail

Address <http://www.seuservice.com/> go

Mac OS X Microsoft MacTopia SegaService.com

SEGA SERVICE

- what's new
- manuals
- bulletins
- assemblies

The NEW I/R Gun Protect Bd !!



(Click here for details)

SEGA SERVICE

- Bulletins
- Darl's Office
- Game Manuals
- Search
- What's New

If you have any questions or comments about this site please E-Mail to Darl.Davidson@seu.sega.com

POWERED BY
Mac OS X

[\[what's new\]](#) [\[manuals\]](#) [\[bulletins\]](#) [\[assemblies\]](#) [\[Search\]](#) [\[staff\]](#) [\[Darl's office\]](#)
[\[Return/Parts Policy\]](#) [\[warranty\]](#) [\[corporate info\]](#) [\[plugins\]](#) [\[Non-framed page\]](#)

You will need the following items to view this page in its entirety.

Get Acrobat Reader GET Microsoft Internet Explorer GET Microsoft Internet Explorer

All Platforms Windows Macintosh

Internet zone

BEFORE USING THE PRODUCT, BE SURE TO READ THE FOLLOWING:

To maintain the safety:

To ensure the safe usage of the product, be sure to read the following before using the product. The following instructions are intended for the users, operators and the personnel in charge of the operation of the product. After carefully reading and sufficiently understanding the warning displays and cautions, handle the product appropriately. Be sure to keep this manual nearby the product or elsewhere convenient for referring to it when necessary.

Herein, explanations which require special attention are enclosed with dual lines. Depending on the potentially hazardous degrees, the terms of WARNING, CAUTION, etc. are used. Be sure to understand the contents of the displays before reading the text.



Indicates that mishandling the product by disregarding this warning will cause a potentially hazardous situation which can result in death or serious injury.



Indicates that mishandling the product by disregarding this caution will cause a slight hazardous situation which can result in personal injury and or material damage.

For the safe usage of the product, the following pictographs are used:



Indicates “HANDLE WITH CARE.” In order to protect the human body an equipment, this display is attached to places where the Owner’s Manual and or Service Manual should be referred to.

- **Perform work in accordance with the instructions herein stated.**
Instructions for work are explained by paying attention to the aspect of accident prevention. Failing to perform work as per the instructions can cause accidents. In the case where only those who have technical expertise should perform the work to avoid hazardous situation, the instructions herein state that the serviceman should perform such work.
- **Be sure to turn off power before working on the machine.**
To prevent electric shock, be sure to turn off power before starting the work in which the worker touches the interior of the product. If the work is to be performed in the power-on status, the Instruction Manual herein always states to that effect.
- **Be sure to ground the Earth Terminal** (this, however, is not required in the case where a power cord with earth is used).
This product is equipped with the Earth Terminal. When installing the product, Connect the Earth Terminal to the “accurately grounded indoor earth terminal” by using an earth wire. Unless the product is grounded appropriately, the user can be subject to electric shock. After performing repair, etc. for the Control equipment, ensure that the Earth Wire is firmly connected to the Control equipment.
- **Ensure that the Power Supply used is equipped with an Earth Leakage Breaker.**
This product does not incorporate the Earth Leakage Breaker. Using a power supply which is not equipped with the Earth Leakage Breaker can cause a fire when earth leakage occurs.
- **Be sure to use fuses which meet the specified rating.** (only for the machines which use fuses).
Using fuses exceeding the specified rating can cause a fire and electric shock.

- **Specification changes (removal of equipment, conversion and addition) not designated by SEGA are not allowed.**
The parts of the product include warning labels for safety, covers for personal protection, etc. It is very hazardous to operate the product by removing parts and or modifying the circuits. Should doors, lids and protective parts be damaged or lost, refrain from operating the product, and contact where the product was purchased from or the office herein stated. SEGA shall not be held responsible for any accidents, compensation for damage to a third party, resulting from the specifications not designated by SEGA.
 - **Ensure that the product meets the requirements of appropriate Electrical Specifications.**
Before installing the product, check for Electrical Specifications. SEGA products have a nameplate on which Electrical Specifications are described. Ensure that the product is compatible with the power supply voltage and frequency requirements of the location. Using any Electrical Specifications different from the designated Specifications can cause a fire and electric shock.
 - **Install and operate the product in places where appropriate lighting is available, allowing warning labels to be clearly read.**
To ensure safety for the customers, labels and printed instructions describing potentially hazardous situation are applied to places where accidents can be caused. Ensure that where the product is operated has sufficient lighting allowing the warnings to be read. If any label is peeled off, apply it again immediately. Please place an order with where the product was purchased from or the office herein stated.
 - **When handling the Monitor, be very careful. (Applies only to the product w/monitor.)**
Some of the monitor (TV) parts are subject to high tension voltage. Even after running off power, some portions are still subject to high tension voltage sometimes. Monitor repair and replacement should be performed only by those technical personnel who have knowledge of electricity and technical expertise.
 - **Be sure to adjust the monitor (projector) properly. (Applies only to the product w/monitor.)**
Do not operate the product leaving on-screen flickering or blurring as it is. Using the product with the monitor not properly adjusted may cause dizziness or a headache to an operator, a player, or the customers.
 - **When transporting or reselling this product, be sure to attach this manual to the product.**
In the case where commercially available monitors and printers are used in this product, only the contents relating to this product are explained herein. Some commercially available equipment has functions and reactions not stated in this manual. Read this manual together with the specific Instruction Manual of such equipment.
- Descriptions herein contained may be subject to improvement changes without notice.
 - The contents described herein are fully prepared with due care. However, should any question arise or errors be found, please contact SEGA.

INSPECTIONS IMMEDIATELY AFTER TRANSPORTING THE PRODUCT TO THE LOCATION.

Normally, at the time of shipment, SEGA products are in a status allowing for usage immediately after transporting to the location. Nevertheless, an irregular situation may occur during transportation. Before turning on power, check the following points to ensure that the product has been transported in a satisfactory status.

- Are there any dented portions or defects (cuts, etc.) on the external surfaces of the cabinet?
- Are Casters and Adjusters, damaged?
- Do the power supply voltage and frequency requirements meet with those of the location?
- Are all wiring connectors correctly and securely connected? Unless connected in the correct direction, connector connections can not be made accurately. Do not insert connectors forcibly.
- Do power cords have cuts and dents?
- Do the fuses used meet specified rating? Is the Circuit Protector in an energized status?
- Are all accessories available?
- Can all Doors and Lids be opened with the Accessory keys? Can Doors and Lids be firmly closed?

TABLE OF CONTENTS

BEFORE USING THE PRODUCT, BE SURE TO READ THE FOLLOWING:

TABLE OF CONTENTS

INTRODUCTION OF THE OWNER'S MANUAL

1. HANDLING PRECAUTIONS	1 - 2
2. PRECAUTIONS CONCERNING INSTALLATION LOCATION	3 - 4
3. OPERATION	5 - 6
4. ASSEMBLING AND INSTALLATION	7 - 9
5. PRECAUTIONS TO BE HEEDED WHEN MOVING THE MACHINE	10
6. NAME OF PARTS.....	11
7. GAME DESCRIPTION.....	12
8. HOW TO PLAY.....	13
9. GAME SETTINGS	14 - 15
10. GAMEBOARD CONFIG SETTINGS.....	16
11. GAME ERROR CODES.....	17
12. TICKET DOOR.....	18
TICKET DISPENSOR.....	19 - 22
14. DESIGN RELATED PARTS.....	23
15. PARTS.....	24 - 36
16. WIRING DIAGRAMS	XXX

SPECIFICATIONS

Installation Space	: 36 inches width X 68 inches length
Height	: 67 inches
Width	: 36 inches
Length	: 48 inches
Weight	: 392 lbs
Power, maximum current	: 240W 2A (AC 120V 60 Hz AREA)

MONITOR : NO MONITOR USED FOR THIS GAME

INTRODUCTION OF THE OWNERS MANUAL

This Owner's Manual is intended to provide detailed descriptions together with all the necessary information covering the general operation of electronic assemblies, electromechanicals, servicing control, spare parts, etc. as regards the product, **CRAZY TAXI REDEMPTION GAME.**

This manual is intended for the owners, personnel and managers in charge of operation of the product. Operate the product after carefully reading and sufficiently understanding the instructions. If the product fails to function satisfactorily, non-technical personnel should under no circumstances touch the internal system. Please contact where the product was purchased from.

Use of this product is unlikely to cause physical injuries or damages to property. However, where special attention is required this is indicated by a thick line, the word "IMPORTANT" and its sign in this manual.



Indicates that mishandling the product by disregarding this display can cause the product's intrinsic performance not to be obtained, resulting in malfunctioning.

IMPORTANT!

SEGA AMUSEMENTS USA, INC./CUSTOMER SERVICE
45133 Industrial Drive, Fremont, California 94538, U.S.A.
Phone : (415) 701-6580
Fax : (415) 701-6594

DEFINITION OF LOCATION MAINTENANCE MAN AND SERVICEMAN



Non-technical personnel who do not have technical knowledge and expertise should refrain from performing such work that this manual requires the location's maintenance man or a serviceman to carry out, or work which is not explained in this manual. Failing to comply with this instruction can cause a severe accident such as electric shock.

Ensure that parts replacement, servicing & inspections, and troubleshooting are performed by the location's maintenance man or the serviceman. It is instructed herein that particularly hazardous work should be performed by the serviceman who has technical expertise and knowledge.

The location's maintenance man and serviceman are herein defined as follows:

"Location's Maintenance Man" :

Those who have experience in the maintenance of amusement equipment and vending machines, etc., and also participate in the servicing and control of the equipment through such routine work as equipment assembly and installation, servicing and inspections, replacement of units and consumables, etc. within the Amusement Facilities and or locations under the management of the Owner and Owner's Operators of the product.

Activities of Location's Maintenance Man :

Assembly & installation, servicing & inspections, and replacement of units & consumables as regards amusement equipment, vending machines, etc.

Serviceman :

Those who participate in the designing, manufacturing, inspections and maintenance service of the equipment at an amusement equipment manufacturer.

Those who have technical expertise equivalent to that of technical high school graduates as regards electricity, electronics and or mechanical engineering, and daily take part in the servicing & control and repair of amusement equipment.

Serviceman's Activities :

Assembly & installation and repair & adjustments of electrical, electronic and mechanical parts of amusement equipment and vending machines.

LISTED



5K92

AMUSEMENT MACHINE

NOTES:

1. HANDLING PRECAUTIONS

When installing or inspecting the machine, be very careful of the following points and pay attention to ensure that the player can enjoy the game safely.

Non-compliance with the following points or inappropriate handling running counter to the cautionary matters herein stated can cause personal injury or damage to the machine.



- Before performing work, be sure to turn power off. Performing the work without turning power off can cause an electric shock or short circuit. In the case work should be performed in the status of power on, this manual always states to that effect.
- To avoid electric shock or short circuit, do not plug in or unplug quickly.
- To avoid electric shock, do not plug in or unplug with a wet hand.
- Do not expose Power Cords and Earth Wires on the surface, (floor, passage, etc.). If exposed, the Power Cords and Earth Wires are susceptible to damage. Damaged cords and wires can cause electric shock or short circuit.
- To avoid causing a fire or electric shock, do not put things on or damage Power Cords.
- When or after installing the product, do not unnecessarily pull the power cord. If damaged, the power cord can cause a fire or electric shock.
- In case the power cord is damaged, ask for replacement through where the product was purchased from or the office herein stated. Using the cord as is damaged can cause fire, electric shock or leakage.
- Be sure to perform grounding appropriately. Inappropriate grounding can cause an electric shock.
- Be sure to use fuses meeting specified rating. Using fuses exceeding the specified rating can cause a fire or electric shock.
- Completely make connector connections for IC BD and others. Insufficient insertion can cause an electric shock.
- Specification changes, removal of equipment, conversion and/or addition, not designated by SEGA are not permitted.
 - Failure to observe this may cause a fire or an electric shock. Non-compliance with this instruction can have a bad influence upon physical conditions of the players or the lookers-on, or result in injury during play.
 - SEGA shall not be held responsible for damage, compensation for damage to a third party, caused by specification changes not designated by SEGA.
- Be sure to perform periodic maintenance inspections herein stated.



- For the IC board circuit inspections, only the logic tester is allowed. The use of a multiple-purpose tester is not permitted, so be careful in this regard.
- Static electricity from your body may damage some electronics devices on the IC board. Before handling the IC board, touch a grounded metallic surface so that the static electricity can be discharged.
- Some parts are the ones designed and manufactured not specifically for this game machine. The manufacturers may discontinue, or change the specifications of, such general-purpose parts. If this is the case, Sega cannot repair or replace a failed game machine whether or not a warranty period has expired.

◆ PRODUCTION DATE ◆

This SEGA product was produced in the year of:

2003

This signifies that this work was disclosed in 2003.

2. PRECAUTIONS CONCERNING INSTALLATION LOCATION



This product is an indoor game machine. Do not install it outside. Even indoors, avoid installing in places mentioned below so as not to cause a fire, electric shock, injury and or malfunctioning.

- Places subject to rain or water leakage, or places subject to high humidity in the proximity of an indoor swimming pool and or shower, etc.
- Places subject to direct sunlight, or places subject to high temperatures in the proximity of heating units, etc.
- Places filled with inflammable gas or vicinity of highly inflammable/volatile chemicals or hazardous matter.
- Dusty places.
- Sloped surfaces.
- Places subject to any type of violent impact.
- Vicinity of anti-disaster facilities such as fire exits and fire extinguishers.
- The operating (ambient) temperature range is from 5°C to 30°C.

LIMITATIONS OF USAGE REQUIREMENTS



- Be sure to check the Electrical Specifications.
Ensure that this product is compatible with the location's power supply, voltage and frequency requirements.
A plate describing Electrical Specifications is attached to the product.
Non-compliance with the Electrical Specifications can cause a fire and electric shock.
- This product requires the Breaker and Earth Mechanisms as part of the location facilities. Using them in a manner not independent can cause a fire and electric shock.
- Ensure that the indoor wiring for the power supply is rated at 2 A or higher (AC single phase 100 ~ 120 V area). Non-compliance with the Electrical Specifications can cause a fire and electric shock.
- Be sure to independently use the power supply equipped with the Earth Leakage Breaker. Using a power supply without the Earth Leakage Breaker can cause an outbreak of fire when earth leakage occurs.
- Putting many loads on one electrical outlet can cause generation of heat and a fire resulting from overload.
- When using an extension cord, ensure that the cord is rated at 2 A or higher (AC 100 ~ 120 V area). Using a cord rated lower than the specified rating can cause a fire and electric shock.

Operation Area



- For the operation of this machine, secure a minimum area of 36 in. (W) × 68 in. (D). In order to prevent injury resulting from the falling down accident during game play, be sure to secure the minimum area for operation.
- Be sure to provide sufficient space so as to allow this product's ventilation fan to function efficiently. To avoid machine malfunctioning and a fire, do not place any obstacles near the ventilation opening.
- SEGA shall not be held responsible for damage, compensation for damage to a third party, resulting from the failure to observe this instruction.



For transporting the machine into the location's building, the minimum necessary dimensions of the opening (of doors, etc.) are 37 in. (W) and 68 in. (H).

Electric current consumption

MAX. ? A (AC 120 V 60 Hz)

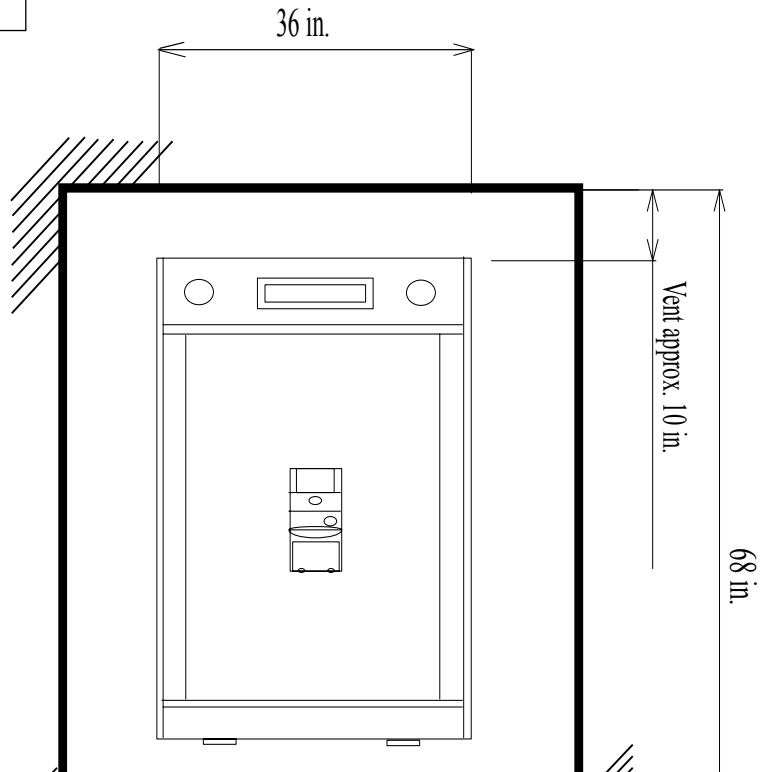

3. OPERATION

PRECAUTIONS TO BE HEEDED BEFORE STARTING THE OPERATION

To avoid injury and trouble, be sure to constantly give careful attention to the behavior and manner of the visitors and players.



In order to avoid accidents, check the following before starting the operation:

- To ensure maximum safety for the players and the customers, ensure that where the product is operated has sufficient lighting to allow any warnings to be read. Operation under insufficient lighting can cause bodily contact with each other, hitting accident, and or trouble between customers.
- It is suggested to ensure a space allowing the players who feel sick while playing the game to take a rest.
- Check if all of the adjusters are in contact with the surface. If they are not, the Cabinet may move and cause an accident.



Ensure that all of the Adjusters are in contact with the floor.



- Immediately stop such violent acts as hitting and kicking the product. Such violent acts can cause parts damage or falling down, resulting in injury due to fragments and falling down.



- Do not put any heavy item on this product. Placing any heavy item on the product can cause a falling down accident or parts damage.
- Do not climb on the product. Climbing on the product can cause falling down accidents. To check the top portion of the product, use a step.
- To avoid electric shock, check to see if door & cover parts are damaged or omitted.
- To avoid electric shock, short circuit and or parts damage, do not put the following items on or in the periphery of the product.
Flower vases, flowerpots, cups, water tanks, cosmetics, and receptacles/containers/vessels containing chemicals and water.

PRECAUTIONS TO BE HEEDED DURING OPERATION (PAYING ATTENTION TO CUSTOMERS)

To avoid injury and trouble, be sure to constantly give careful attention to the behavior and manner of the visitors and players.



- To avoid injury and accidents, those who fall under the following categories are not allowed to play the game.
 - Those who have experienced muscle convulsion or loss of consciousness when playing video game, etc.
 - Intoxicated persons.
 - Persons whose act runs counter to the product's warning displays.
- To avoid injury resulting from falling down and electric shock due to spilled drinks, instruct the player not to place heavy items or drinks on the product.
- To avoid electric shock and short circuit, do not allow customers to put hands and fingers or extraneous matter in the openings of the product or small openings in or around the doors.
- To avoid falling down and injury resulting from falling down, immediately stop the customer's leaning against or climbing on the product, etc.



WARNING: HAZARD TO EPILEPTICS.

- A very small portion of the population has a condition which may cause them to experience epileptic seizures or have momentary loss of consciousness when viewing certain kinds of flashing lights or patterns that are present in our daily environment. These persons may experience seizures while watching some kinds of television pictures or playing certain video games. People who have not had any previous seizures may nonetheless have an undetected epileptic condition.
- If you or anyone in your family has experienced symptoms linked to an epileptic condition (e.g., seizures or loss of awareness), immediately consult your physician before using any video games.
- We recommend that parents observe their children while they play video games. If you or your child experience the following symptoms: dizziness, altered vision, eye or muscle twitching, involuntary movements, loss of awareness, disorientation, or convulsions, DISCONTINUE USE IMMEDIATELY and consult your physician.

4. ASSEMBLING AND INSTALLATION



- Perform assembly work by following the procedure herein stated. Failing to comply with the instructions can cause electric shock hazard.
- Perform assembling as per this manual. Since this is a complex machine, erroneous assembling can cause an electric shock, machine damage and or not functioning as per specified performance.
- When assembling, be sure to use more than one person. Depending on the assembly work, there are some cases in which working by one person alone can cause personal injury or parts damage.
- Ensure that connectors are accurately connected. Incomplete connections can cause electric shock hazard.
- Be careful not to damage the wires. Damaged wires may cause electric shock or short circuit or present a fire risk.
- This work should be performed by the Location's Maintenance Man or Serviceman. Performing work by non-technical personnel can cause a severe accident such as electric shock. Failing to comply with this instruction can cause a severe accident such as electric shock to the player during operation.
- Provide sufficient space so that assembling can be performed. Performing work in places with narrow space or low ceiling may cause an accident and assembly work to be difficult.
- To perform work safely and avoid serious accident such as the cabinet's falling down, do not perform work in places where step-like grade differences, a ditch, or slope exist.



- Handle molded parts with care. Undue weight or pressure may cause them to break and the broken pieces may cause injury.
- To perform work safely and securely, be sure to prepare a step which is in a secure and stable condition. Performing work without using the step can cause violent falling down accidents.

Tools such as a Phillips type screwdriver are required for the assembly work.

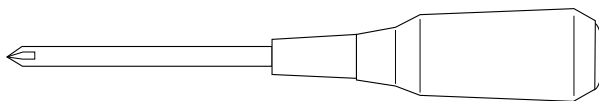

Phillips type screwdriver

TAMPERPROOF
WRENCH
T-15 Torx 8/32 (1)
Tool (Included with Unit)

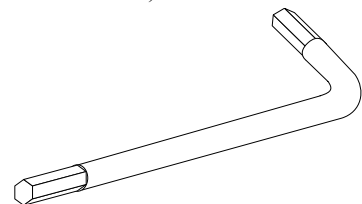

Installing the Car



1- Remove car from packaging inside game cabinet.

2- Attach Connector to base of car and stuff into hole between front wheels.

3- Remove red double sided tape covers and place car on movement rail. Press car down firmly to be sure tape is secure.

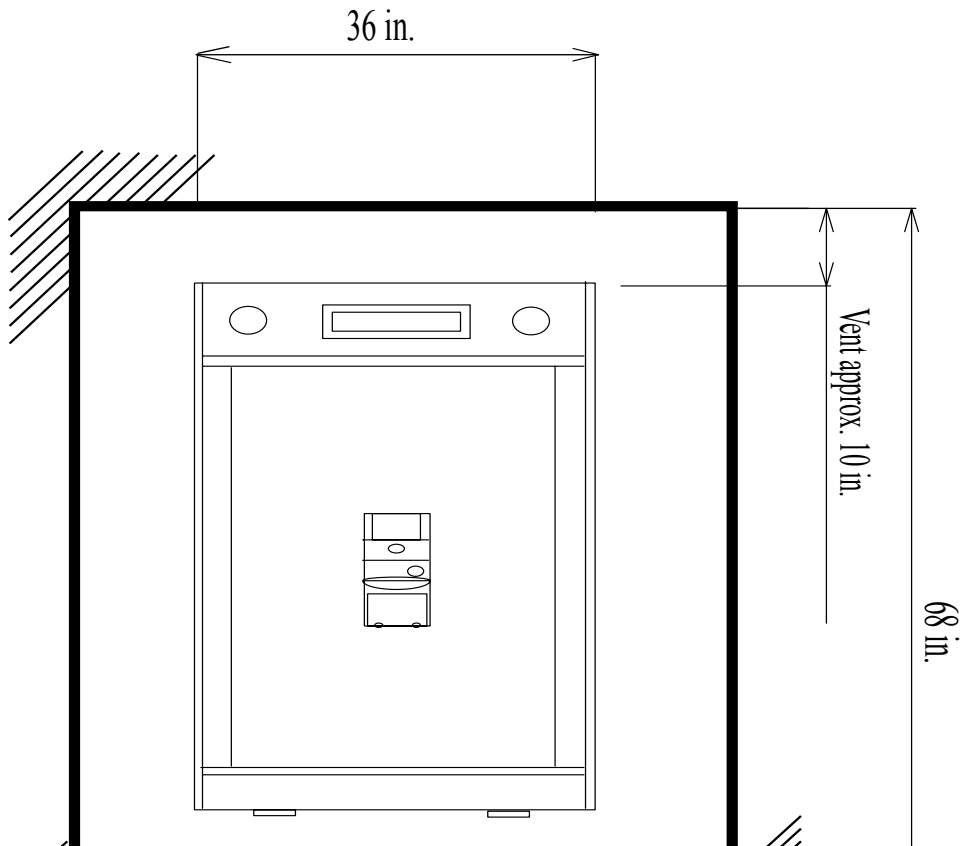

FIG. 6. 2 e
Provide ventilation space for the ventilation opening.
Allow more than 28 in. of space for customer traffic.

POWER SUPPLY, AND EARTH CONNECTION



- Be sure to independently use the power supply socket outlet equipped with an Earth Leakage Breaker. Using a power supply without an Earth Leakage Breaker can cause a fire when electric leakage occurs.
- Ensure that the "accurately grounded indoor earth terminal" and the earth wire cable are available (except in the case where a power cord plug with earth is used). This product is equipped with the earth terminal. Connect the earth terminal and the indoor earth terminal with the prepared cable. If the grounding work is not performed appropriately, customers can be subjected to an electric shock, and the product's functioning may not be stable.
- Ensure that the power cord and earth wire are not exposed on the surface (passage, etc.). If exposed, they can be caught and are susceptible to damage. If damaged, the cord and wire can cause electric shock and short circuit accidents. Ensure that the wiring position is not in the customer's passage way or the wiring has protective covering.
- After wiring power cord on the floor, be sure to protect the power cord. Exposed power cord is susceptible to damage and causes an electric shock accident.

The AC Unit is located inside on one side of Cabinet. The AC Unit has Main SW, Earth Terminal and the Inlet which connects the Power Cord.

- Ensure that the Main SW is OFF.

Power is off when the MAIN SWitch is in the down position. To supply power to the unit, flip the MAIN SWitch upwards.

* Note: Actual Power Supply connection may vary from photo

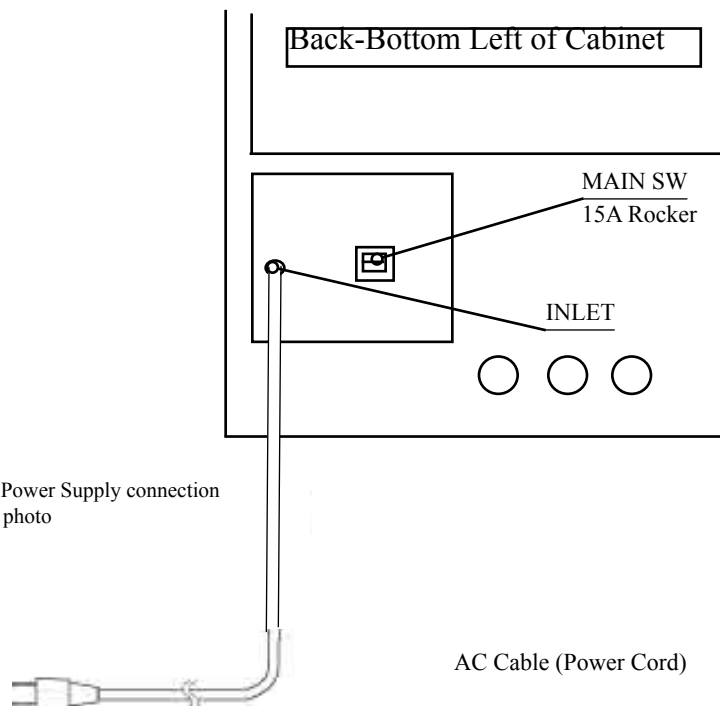

5. PRECAUTIONS WHEN MOVING THE MACHINE



- When moving the machine, be sure to unplug the power plug. Moving the machine with the plug as is inserted can damage the power cord and cause fire and electric shock hazards.
- When moving the machine on the floor, pay careful attention so that adjusters do not tread power cords and earth wires. Damaging the power cords can cause electric shock and short circuit hazards.
- Do not push the cabinet from the left/right when attempting to move the unit. Pushing from the sides may cause the unit to tip and result in injury and damage to parts.



Do not push on any parts made of glass (e.g. Main Plex) or plastic, as these parts may break and result in bodily injury.

6. NAME OF PARTS

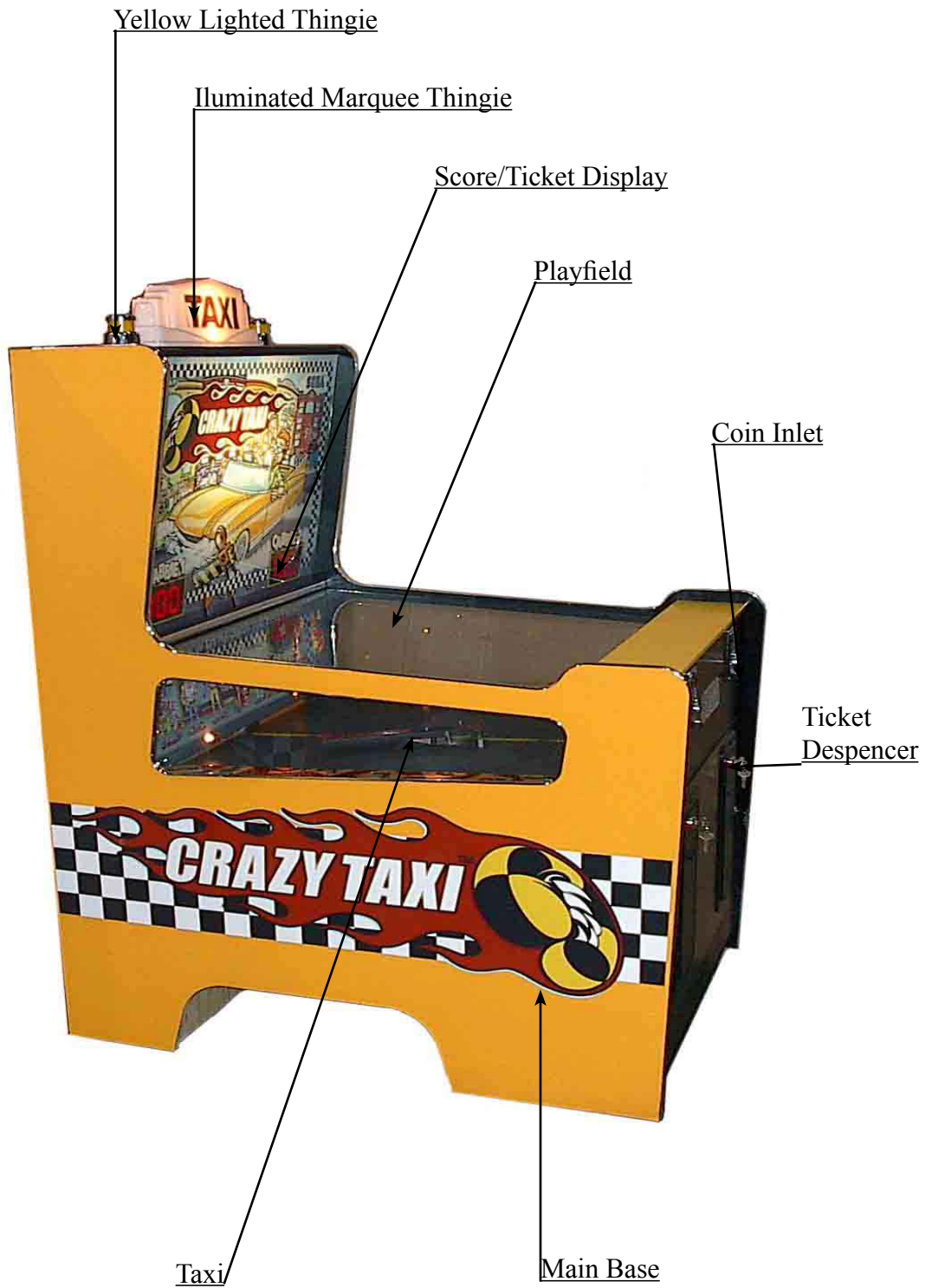

TABLE 1 Dimensions and Weights

	Width x Length x Height	Weight
CABINET	36 in x 48 in x 67 in	392 LBS

7. GAME DESCRIPTION

The following explanations apply to cases where the product is functioning satisfactorily. Should there be anything different then the following contents, some sort of faults may have occurred. Immediately look into the cause of the fault and eliminate the cause thereof to ensure satisfactory operation.

Connect the Power cord to an A/C source, turn on the power switch, then verify the following:

- lights illuminate inside the Taxi Dome
- lights illuminate behind the Marquee Glass
- lights blink behind the Prize Goal
- lights chase behind the people on the Panel Prize Plastic
- lights chase down the sides of the Play Field
- and lights illuminate the headlamps in the Taxi itself

At this time the ticket displays are lit with “100”'s and the taxi begins to move with it's special motion as well as sound emitted from the front speakers.

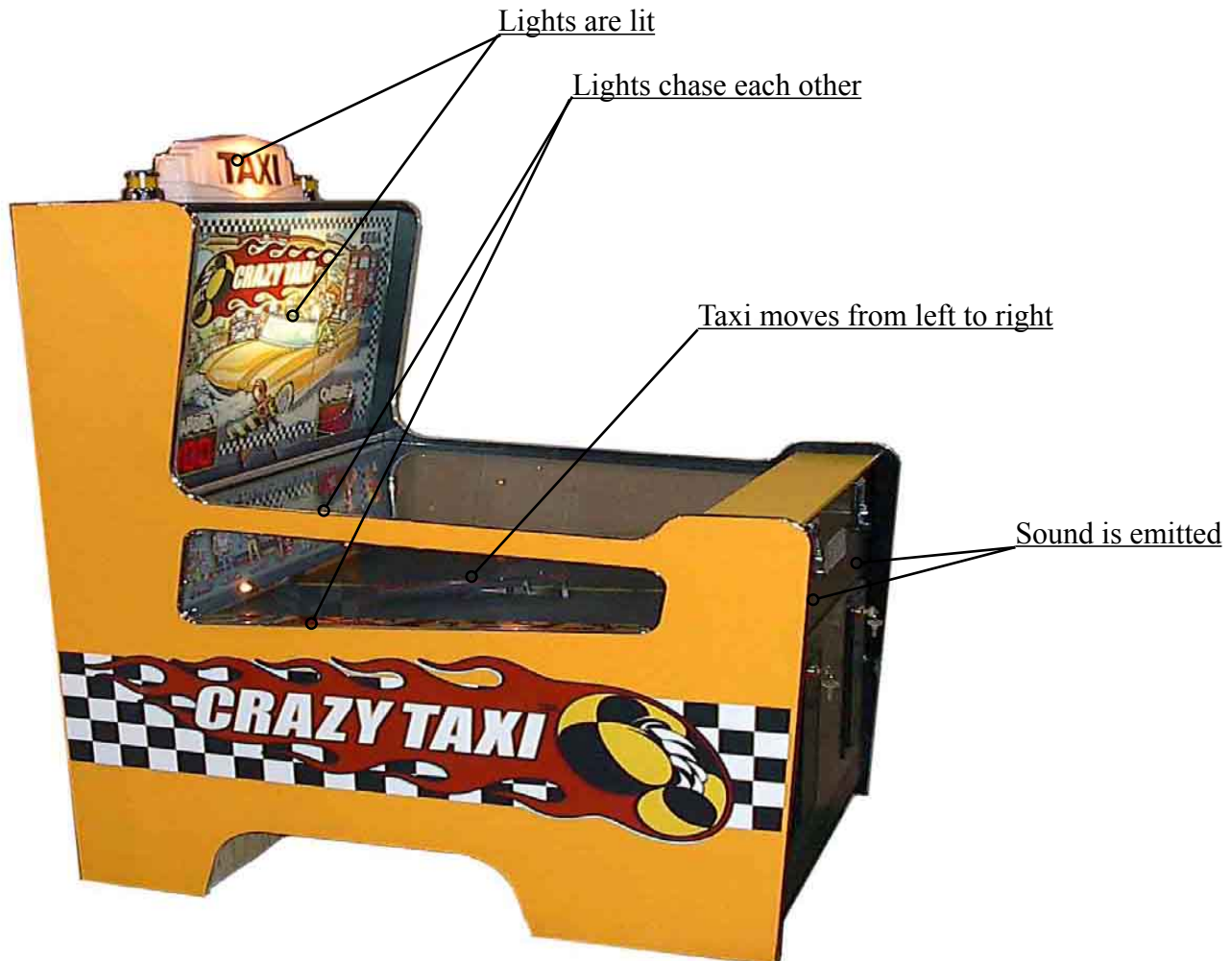

Game Overview

This game is a redemption game. Meaning that you input coins/tokens and after play it dispenses tickets to be redeemed for prizes. Coins/Tokens are inserted into the slots on the front then they are rolled down the Play Field attempting to miss the Taxi and into the Prize Goal area. Depending on which person is lit at the time the coin/token crosses that area is the amount of tickets that are dispensed.

8. HOW TO PLAY

- Play starts with the player inserting a coin/token into a slot on the front of the machine. This token is compared with the token in the compairitor and then released.



Insert Coin/Token

- When this coin/token is released it starts its' trip down the play field. At this time it is possible for the "TAXI" to knock the coin/token on its' side causing a "loser" or it will finish its' travel in the "pick up zone". If it fails to reach the "pick up zone" and the game is set to dispence "Mercy Tickets" they will be outputted at this time.



Coin Rolls down play field

- If the coin/token reaches the "pick up zone" then depending on which "person" was lit on the backboard then that amount is displayed on the ticket display.



Tickets won are displayed

- At this time tickets are dispenced in the amount of what's displayed on the ticket display.



Tickets are dispenced

9. Game Settings

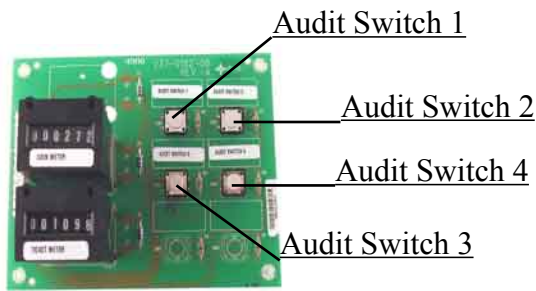

Note: Switches perform various functions during each test.

The following sections will explain their use:

When Player 1 is out of tickets, press AUDIT SWITCH 1. The game will then resume paying out Player 1's tickets.

When Player 2 is out of tickets, press AUDIT SWITCH 2. The game will then resume paying out Player 2's tickets.

When both sides of the game are in idle (nobody is playing), press AUDIT SWITCH 3 to enter the SYSTEM menu. Both displays will show SYS. If the user presses AUDIT SWITCH 1, the game will cycle backward through the menu below. If the user presses AUDIT SWITCH 2, the game will cycle forward through the menu below.

- 1- SYS (for SYStem)
- 2- AUD (for AUDits)
- 3- ADJ (for ADJustments)
- 4- VOL (for VOLume)
- 5- END (for exit back to game play)

Press AUDIT SWITCH 4 to enter the mode on the display (either system, audits, volume, or end)

SYStem

For SYStem, the left display will show SYS. The right display will show the test number. AUDIT SWITCH 4 will move from one test to the next.

- 1- SCORE 1 AC Lamp Flashing
- 2- SCORE 2 AC Lamp Flashing
- 3- SCORE 3 AC Lamp Flashing
- 4- SCORE 4 AC Lamp Flashing
- 5- SCORE 5 AC Lamp Flashing
- 6- SCORE 6 AC Lamp Flashing
- 7- SCORE 7 AC Lamp Flashing
- 8- SCORE 8 AC Lamp Flashing
- 9- SCORE 1 906 Lamp Flashing
- 10- SCORE 2 906 Lamp Flashing
- 11- SCORE 3 906 Lamp Flashing
- 12- SCORE 4 906 Lamp Flashing
- 13- SCORE 5 906 Lamp Flashing
- 14- SCORE 6 906 Lamp Flashing
- 15- SCORE 7 906 Lamp Flashing

- 16- SCORE 8 906 Lamp Flashing
- 17- WIN Light Player 1 Flash
- 18- WIN Light Player 2 Flash
- 19- GI Lamps Cycling
- 20- Left Turn Signal
- 21- Right Turn Signal
- 22- Opto Player 1 (Score Lamp 1 will be on if the switch is made, off is switch is open)
- 23- Opto Player 2 (Score Lamp 1 will be on if the switch is made, off is switch is open)
- 24- Coin Mech 1 (Score Lamp 1 will be on if the switch is made, off is switch is open)
- 25- Coin Mech 2 (Score Lamp 1 will be on if the switch is made, off is switch is open)
- 26- Left Limit Switch (Score Lamp 1 will be on if the switch is made, off is switch is open)
- 27- Right Light Switch (Score Lamp 1 will be on if the switch is made, off is switch is open)
- 28- Car Motor (Car Motor will run)
- 29- Shake Motor (Shake Motor will run)

Pressing AUDIT SWITCH 4 during test 29 will cause the game to go back to the main SYStem Menu (at the END slot (“END” will be displayed)).

ADJustments

When “ADJ” is displayed to the left AUDIT SWITCH 1 will increase the adjustment value. AUDIT SWITCH 2 will decrease the adjustment.

- 1- Win chance (10 ~ 30), default is 20

Pressing AUDIT SWITCH 4 will save the adjustment and return the game back to the main SYStem menu (at the END slot (“END” will be displayed))

AUDits

When “AUD” is displayed to the left pressing AUDIT SWITCH 4 will advance to the next audit. AUDIT SWITCH 3 will clear the current audit.

- 1- Total number or tickets (rolls over at 99,999)
- 2- Total number of coins (rolls over at 99,999)
- 3- Total number of Jackpots (rolls over at 999)

Pressing AUDIT SWITCH 4 during test 29 will cause the game to go back to the main SYStem Menu (at the END slot (“END” will be displayed)).

VOLume

When “VOL” is displayed to the left pressing AUDIT SWITCH 4 will save the volume setting and return the game back to the main SYStem menu at the “END” slot. Pressing AUDIT SWITCH 1 will decrease the volume. Pressing AUDIT SWITCH 2 will increase the volume. During VOLume, the game will have the drum track looping, changing volume as the user presses AUDIT SWITCH 1 and AUDIT SWITCH 2.

END

Pressing AUDIT SWITCH 4 while “END” is displayed will Exit the Main SYStem menu and return the game back to game play.

10. Gameboard Config Settings

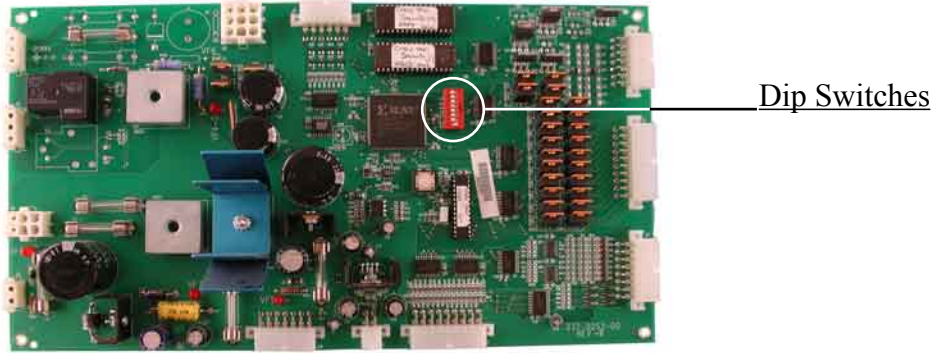

Dip Switches

Jackpot

Dip1 Dip2

Off	Off	50 Pt Jackpot
On	Off	100 Pt Jackpot
Off	On	Progressing Jackpot
On	On	Progressing Jackpot

Ticket Payout

Dip3

Off	Normal Ticket Payout
On	Two Point Ticket Payout

Mercy Tickets (Tickets Dispensed if coin fails to cross Opto. Sensors)

Dip4 Dip5

Off	Off	No Mercy Tickets
On	Off	1 Mercy Ticket
Off	On	2 Mercy Tickets
On	On	3 Mercy Tickets

Game Difficulty (Cycling Lamp Speed)

Dip6 Dip7

Off	Off	Fast
On	Off	Medium
Off	On	Slow
On	On	Really Slow

Dip8

Not Used

11. Game Error Codes

This game only has 1 error code which is CBO (which means that the cashbox switch is not set and the game will not play when this switch is open and the error code is on the display).



Cashbox Switch

12. TICKET DOOR

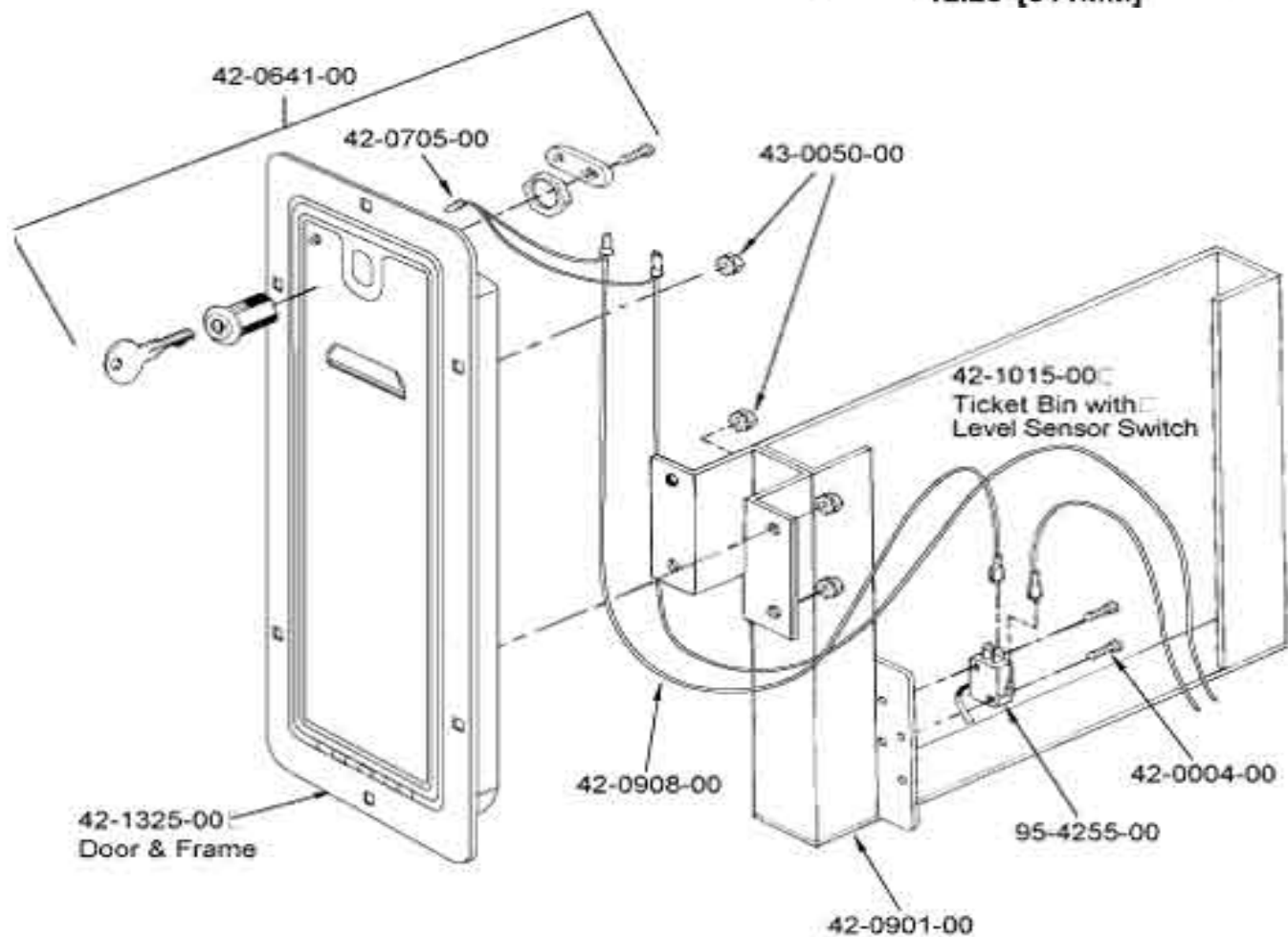
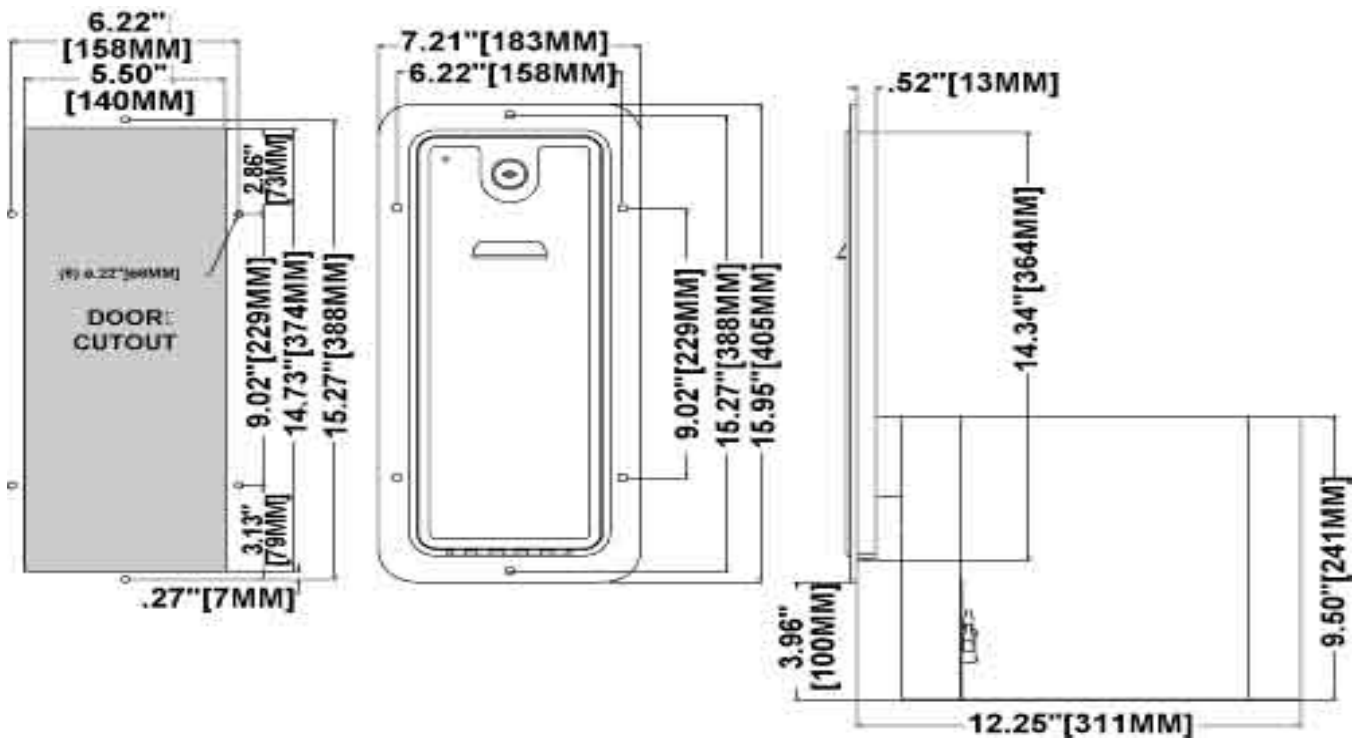

- Ticket Door is a Happ Controls Part #40-0549-00 and comes with the Ticket Stickers Happ Controls Part#42-1378-00
- There is a ticket Meter in this game for an ongoing ticket count.

TICKET DISPENSER

“Quick Release” Ticket Dispenser

Features All Models

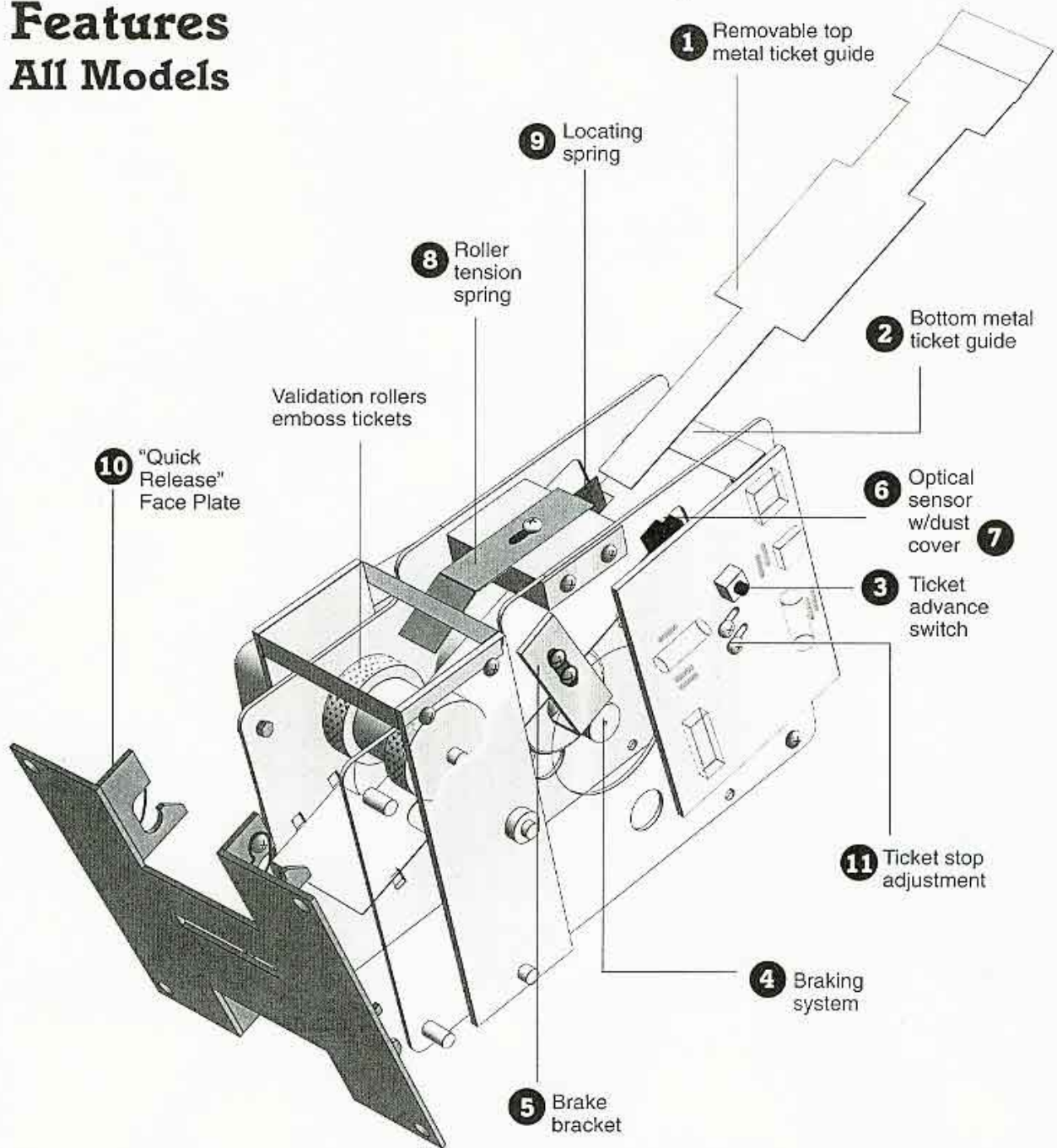

2

Deltronic Labs, Inc. 120 Liberty Lane, Chalfont, PA 18914 • 215-997-8616 • FAX# 215-997-9506 • www.deltroniclabs.com

1 Top Metal Ticket Guide
For servicing, the top metal ticket guide can be removed and replaced. With unit facing you, gently spread side plates with thumb and index finger. Tilt guide to right at 45° angle and snap left side tab out and pull straight back. When replacing, simply reverse these steps. Note there is no need to spread side plates while replacing guide. Tilt to right and insert right tab first.
Note: When PCB has opto-sensor cover, guide is inserted over sensor then directed down to right. Be sure guide is **BELOW** brake bracket screws when replaced.

2 Bottom Metal Ticket Guide
The longer, more durable ticket guide extends through the face plate allowing for better guidance plus a larger opening in the face plate prevents curled tickets from catching.

3 Loading of tickets with ticket advance switch
Tickets are inserted in the rear of machine between the top and bottom ticket guides and pushed forward to the rollers. If needed, gently push the locating spring (9) away from the ticket guides. Then push the ticket advance switch until you see the edge of first ticket.

4 Braking system
Our impressive new braking system eliminates brake slippage allowing foolproof, accurate dispensing. The new design also reduces wear and tear on the dispenser.

5 Brake bracket
The brake is easily accessible and can be adjusted to engage immediately when ticket is pulled. (Minimum of 1/8" from brake wheel.)

6 Opto-Sensor
Included as part of the controller is an opto-electronic beam sensor which detects the notch between tickets. The output of the ticket sensing circuitry is an open collector transistor.

7 Opto-Sensor Dust Cover
In addition, an optical sensor dust cover is also included to eliminate the possibility of ticket dust accumulating on the optical sensor. This increases the accuracy of the ticket count and reduces maintenance.

8 Roller Tension Spring
The roller tension springs keep constant tension on tickets which insures proper delivery and prevents the tickets from being "pulled through" when the dispenser is idle. To increase the tension, loosen the screw and move the spring forward. Tension is correctly adjusted when tickets cannot be pulled from the dispenser and validation rollers lightly emboss the tickets.

9 Locating Spring
The ticket guide spring insures that the notches in the tickets pass through the opto-sensor. To decrease tension, loosen the screw and move the outer tension spring up. This changes the tension on the inner spring. The tickets should be snug between the spring and the side plate but not deformed by the excess tension. The spring is adjusted at the factory for 1-5/32" wide tickets and positioned 1/8" from ticket guides.

10 "Quick Release" Face Plate
The dynamic new design allows the ticket dispenser to "quickly release" from its face plate on your cabinet or ticket door. This can be done manually and no tools are needed. This gives you complete access to the front of the rollers and to the ticket guides. Plus you can "snap out" one ticket dispenser and immediately replace it with another in just seconds.

11 Ticket Stop Adjustment
The ticket stop adjustment allows you to position the tickets while the machine is off. The tickets should protrude through the slot at least 1/16". The ticket dispenser PC board is mounted on spacer with two screws with washers in two slotted holes. Loosening the screws and moving the board forward will allow the tickets to stop further out beyond the edge of the slot.

Dispenser Specifications

The quick release ticket dispenser greatly improves serviceability and reduces maintenance. Now standard on all Deltronic Labs Ticket Dispensers.

- Low voltage operations, only 12V DC
- Solid state output allows interfacing with electronic games
- Compact size, only 3-1/8" W x 4" H x 5-1/2" L
- Weight: 2-1/4 lbs.
- Validation "diamond" mark identifies tickets that have been dispensed.
- Adjustable ticket stop
- Dispenses 2"L x 1-5/32"W tickets
- One year warranty
- Standard face plate: 4"H x 3-3/4"W
- Narrow face plate: 4"H x 3-1/8"W

Control Board

Rev. 8

DL-1275 with 12V meter output

This dispenser is controlled by the game software. The game turns on the dispenser with a logic high signal and monitors a return notch signal from the ticket dispenser to turn it off. It will dispense as many tickets as games options allow.

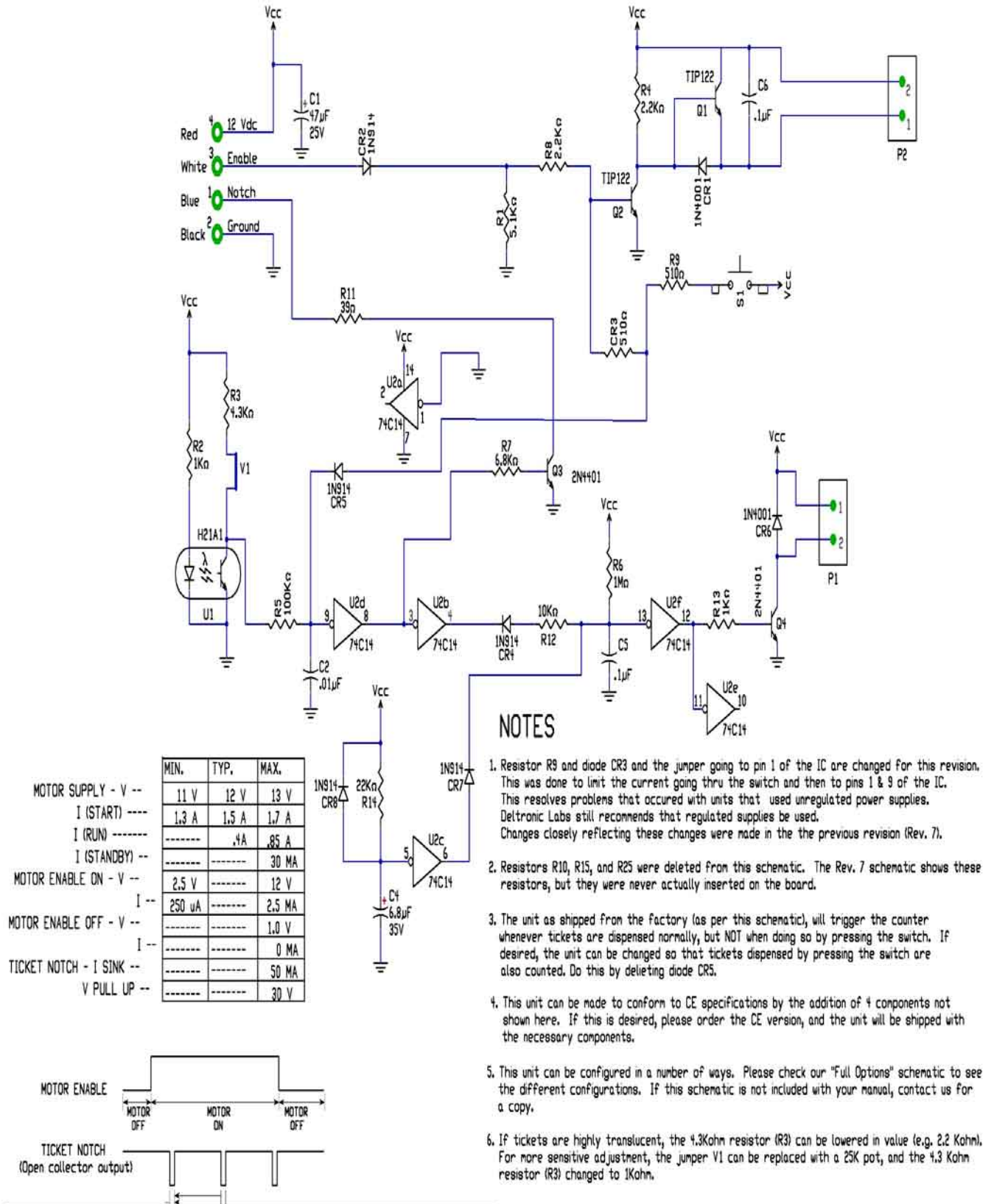

	MIN.	TYP.	MAX.
MOTOR SUPPLY - V --	11 V	12 V	13 V
I (START) ----	1.3 A	1.5 A	1.7 A
I (RUN) -----	-----	.4 A	.85 A
I (STANDBY) --	-----	-----	30 MA
MOTOR ENABLE ON - V --	2.5 V	-----	12 V
I --	250 µA	-----	2.5 MA
MOTOR ENABLE OFF - V --	-----	-----	1.0 V
I --	-----	-----	0 MA
TICKET NOTCH - I SINK --	-----	-----	50 MA
V PULL UP --	-----	-----	30 V

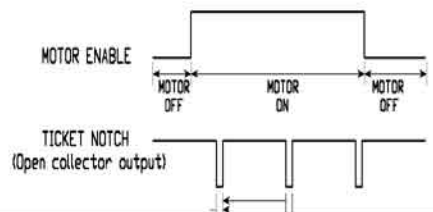

Ticket Dispenser Assembly

DETAILS OF PARTS

P/N	QTY	DELTRONIC LABS P/N	NAME
11	1	SHFT-IDLRLR/TD	IDL. ROLLER SHAFT
12	1	RM-SFTMTR/TD	MOTOR PIVOT SHAFT
13	1	SPAC PIVBLK/TD/4HOL	PIVOT BRACKET SPAC
14	1	RM-SPCPB/TD	SPACER BLOCK
15	2	RM-RLRIDL/TD/VALD	IDLER ROLLER
16	1	RM-RLRDRV/TD/VALD	DRIVER ROLLER
17	2	SPRG-TENSN/TD	TENSION SPRING
18	2	RM-BKTPVT/TD	BRAKE WHEEL
19	1	RM-PANLFT/TD/NOPM	FRONT PANEL
20	1	RM-WHLBRK/TD	BRAKE WHEEL
21	1	SPR-LOCA/TD	LOCATING SPRING
22	1	RM-BRKTBRK/TD	BRAKE BRACKET
23	1	RM-BKTTUB/TD/3/8	URETHANE BRAKE
24	1	PCBD-12275/TD	PC BOARD
25	1	RM-MOTOR/TD	MOTOR
26	2	RM-PLATFR/TD	FRAME PLATE
27	1	RM-CONN2P/TE/20G	2-PIN FEMALE CONN.
28	4	BRNG-F312/TT/BRASS	BUSHING
29	1	SPAC-PCBD/TD	P.C. BOARD SPACER
30	1	SPAC/HEX/TD/1-1/4	HEX SPACER 1-1/4"
31	1	RM.1M/TT/50V	IMFD 50V
32	1	SPAC-HEX/TD/1/4"	STAND OFF
33	1	GUID-BOTTOM/TD/MET	LOWER GUIDE MET.
34	4	RING-E25RT/TT	RETAINING RING
35	1	GUID-TOP/TD/MET	GUIDE TOP METAL
36	2	PULY-SP212/TE/NYLN	SPACER WASHER
37	2	SPRG-FRONT/TP/TD	SPRING FRONT-PLATE
38	4	RM-PEMNUT/TD/FRPL	PEMNUT FRAME
39	2	RM-PEMNUT/TD/FRPN	PEMNUT FRONT
40	1	COVR-H21A/TD/OPTO	DUST COVER
41	1	CONN MOLEX/TD/4PM	4 WIRE MOLEX MA.
42	1	RM-LABEL/TD/ALUM	LABEL ALUMINUM
43	1	WIRE-REDBLK/TD/MOTOR	
44	2	SPAC-PIVBRK/TD/HEX	SPACER 1/4" HEX

* Order by Model #

** Note: F/N #36 replaces .032 and .063 spacer washers.

*** Note: F/N #44 replaces large spacer block.

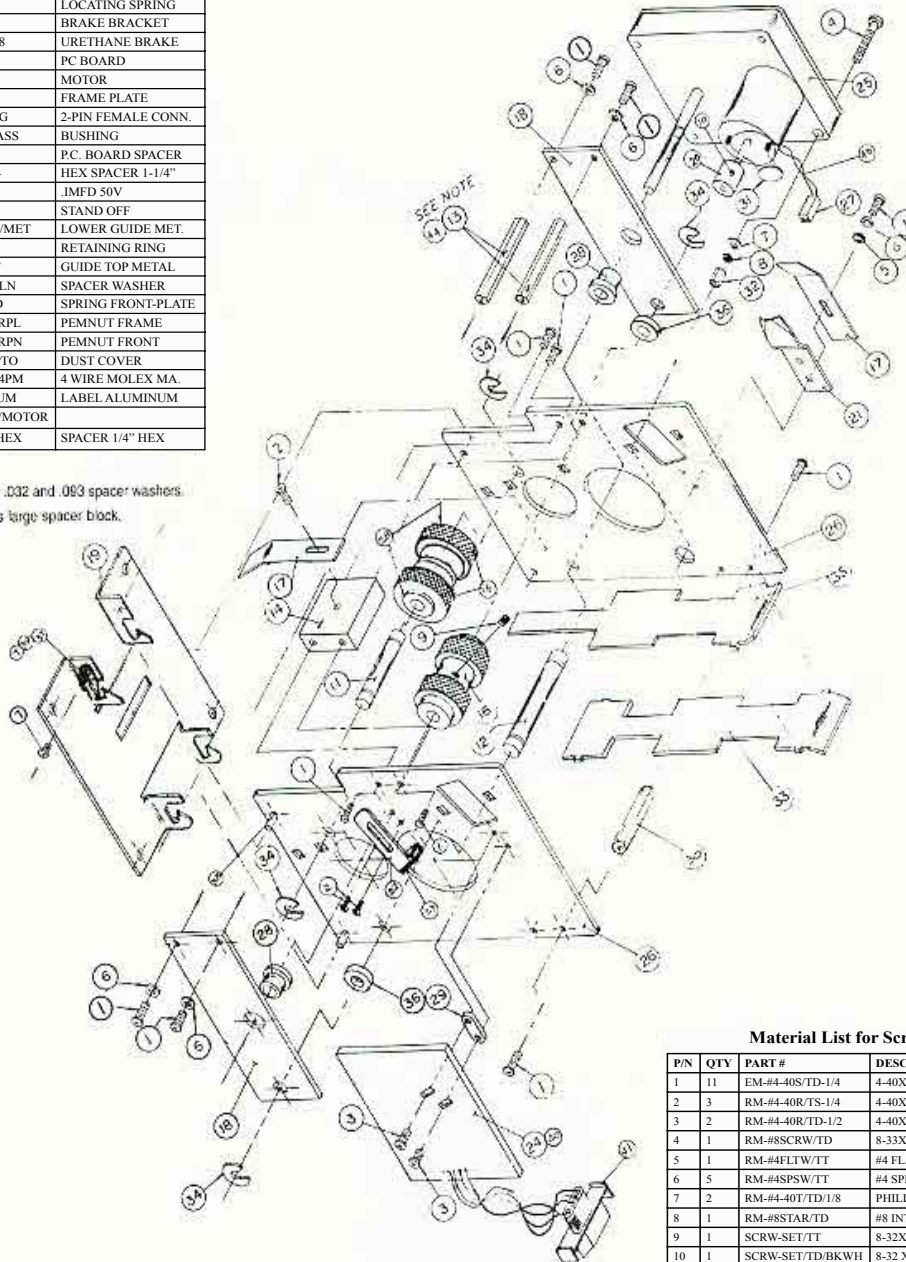

Material List for Screws

P/N	QTY	PART #	DESCRIPTION
1	11	EM-#4-40S/TD-1/4	4-40X1/4" SCREW
2	3	RM-#4-40R/TS-1/4	4-40X1/4" WASHER HEAD
3	2	RM-#4-40R/TD-1/2	4-40X1/2" WASHER HEAD
4	1	RM-#8SCRW/TD	8-33X1-1/4"
5	1	RM-#4FLTW/TT	#4 FLAT WASHER
6	5	RM-#4SPSW/TT	#4 SPLIT LOC. WASHER
7	2	RM-#4-40T/1/8	PHILLIPS TRUSSHEAD
8	1	RM-#8STAR/TD	#8 INT STAR WASHER
9	1	SCRW-SET/TT	8-32X3/16" SET SCREW
10	1	SCRW-SET/TD/BKWH	8-32 X 1/8 SET SCREW

Deltronic Labs, Inc. 120 Liberty Lane, Chalfont, PA 18914 • 215-997-8616 • FAX# 215-997-9506 • www.deltroniclabs.com

14. DESIGN RELATED PARTS

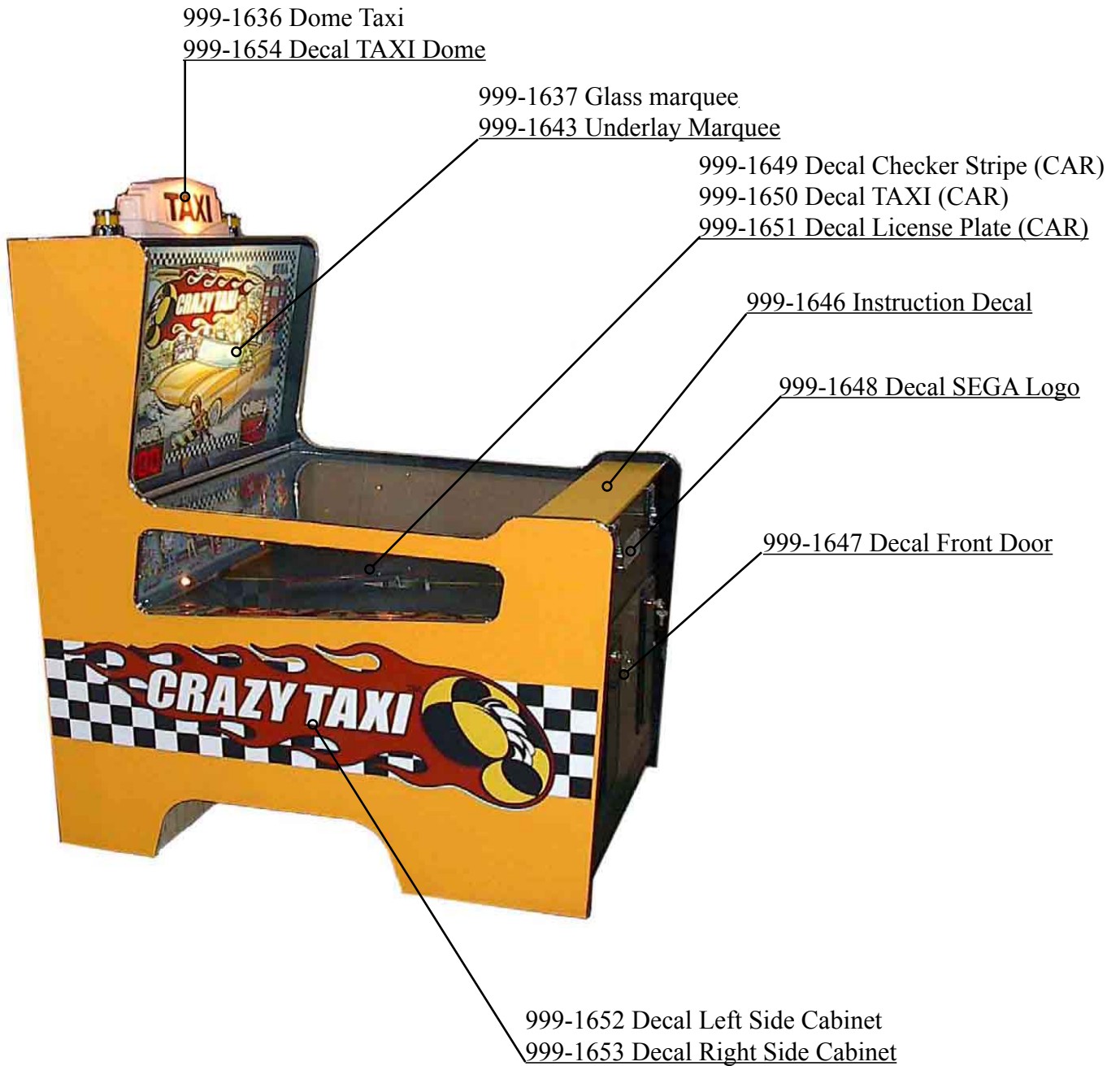

15. PARTS



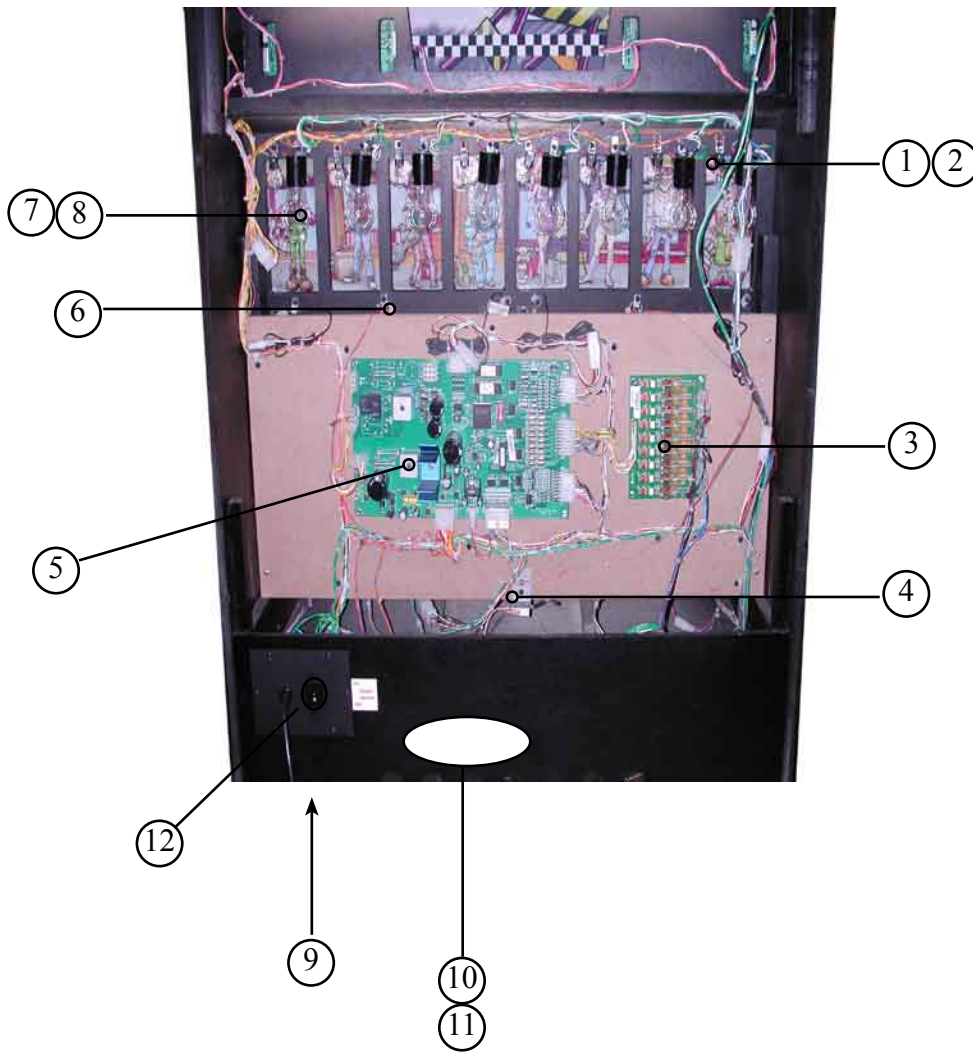

Rear Door Section

(P 1/2)









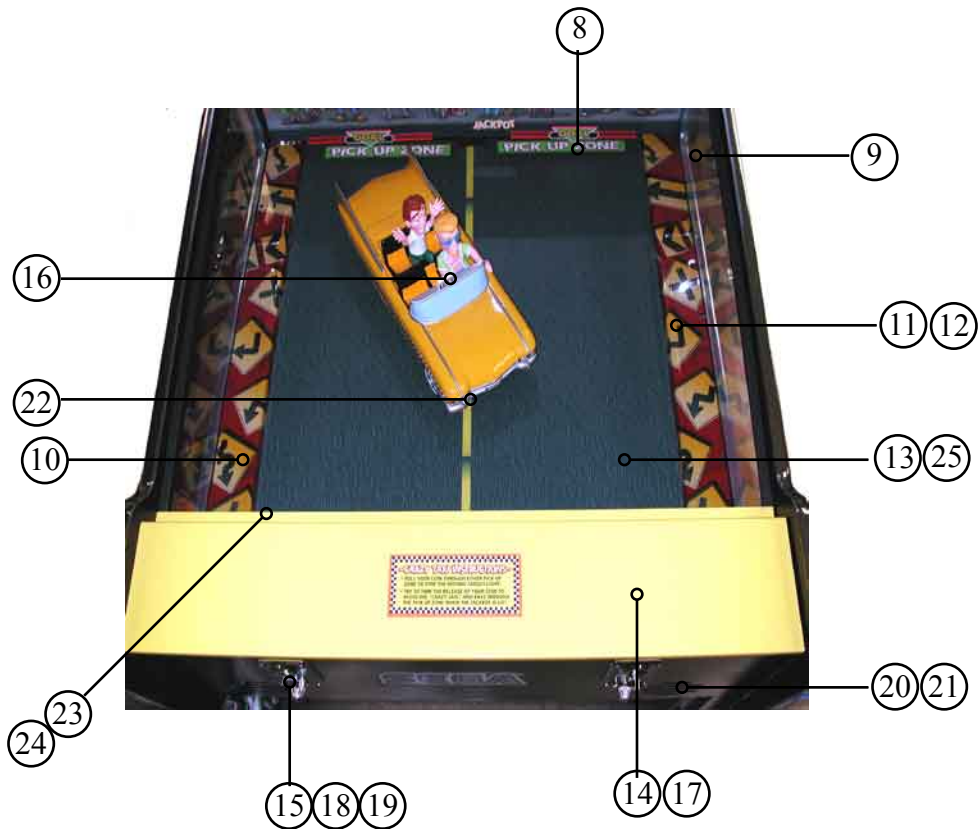

Rear Door Section



(P 2/2)

Item Number	Part Number	Description	Picture
1	Local Purchase	Bulb CEC C906	
2	Local Purchase	Socket Base Wedge CEC #4087-3	Photo Not available at time of print.
3	998-0180	Board AC Driver #237-0081-01	
4	999-1630	Cashbox Switch	Photo Not available at time of print.
5	998-0181	CPU Board #237-0252-02	
6	998-0182	Opto Kodenshi #PSS-S13 Match Pair EM & RCVR	Photo Not available at time of print.
7	Local Purchase	Bulb Appliance AC 40W 120V	
8	Local Purchase	Lamp Socket AC	Photo Not available at time of print.
9	999-0167	Leg Leveler 1/2-13 3" L	Photo Not available at time of print
10	999-1627	Transformer MCI-4-06-8016	Photo Not available at time of print
11	999-1628	Transformer MCI-4-06-8012	Photo Not available at time of print
12	999-0676	On-Off Switch 15A Rocker	Photo Not available at time of print



Item Number	Part Number	Description	Picture
1	999-1636	Dome Taxi	
2	Local Purchase	Bulb Tubular AC 40W 120V	
3	Local Purchase	Lamp Socket AC	
4	999-1620	Light Tower Yellow	
5	999-1669	Marquee Retainer Strip	
6	999-1637	Marquee Glass	Photo Not available at time of print.
7	999-1634	Pickup Plex (numbers and people)	
8	999-1641	GOAL Pink Plex	
9	999-1638	Side Window Plex	



Item Number	Part Number	Description	Picture
10	999-1633	Side Guard Right	
11	999-1632	Side Guard Left	
12	Local Purchase	Bulb 161 14V Wedge Base	
13	999-1673	Playfield	
14	999-1674	Playfield Glass Retainer	
15	999-1676	Coin Chute	
16	999-1635	Car Molded	
17	999-1675	Playfield Glass Retainer Holder	
18	999-1640	Panel Coin Chute Guide	
19	999-1639	Cover Coin Chute	Photo Not available at time of print.

Item Number	Part Number	Description	Picture
20	999-1624	Speaker 4in 4ohm 30W	
21	999-1670	Speaker Grill 4in	
22	Local Purchase	Lamp Headlight AC/ DC White Incandescent	Photo Not available at time of print.
23	999-1671	Coin Guard	
24	999-1672	Playfield Glass Support	
25	999-1644	Playfield Glass	Photo Not available at time of print.



Marquee Internal



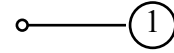
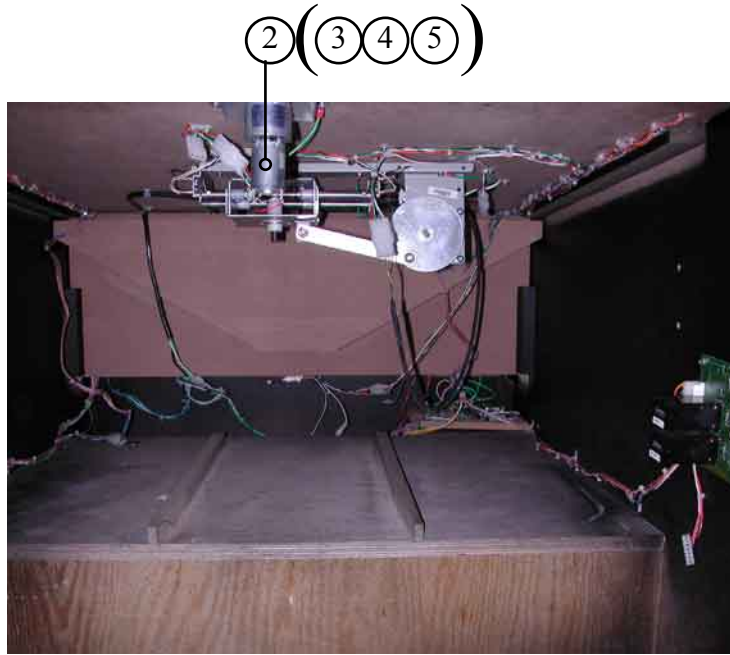

(P 2/2)

Item Number	Part Number	Description	Picture
1	Local Purchase	Lamp Fluorescent 15W 18in Coolwhite	
2	998-0178	Board BLK Display	
3	999-1642	Vent Grill 3in X 18" Black PowderCoat	Photo Not available at time of print.



Internal Devices

(P 2/2)

Item Number	Part Number	Description	Picture
1	998-0179	Audit Board	
2	999-1679	Shaker Motor Assy.	
3	999-1623	Shaker Motor	
4	999-1677	Shaker Bracket	
5	999-1678	Shaker Connector	
6	999-1626	Deltronic Ticket Dispenser	Photo Not available at time of print.
7	999-1629	Ticket Out Switch	Photo Not available at time of print.

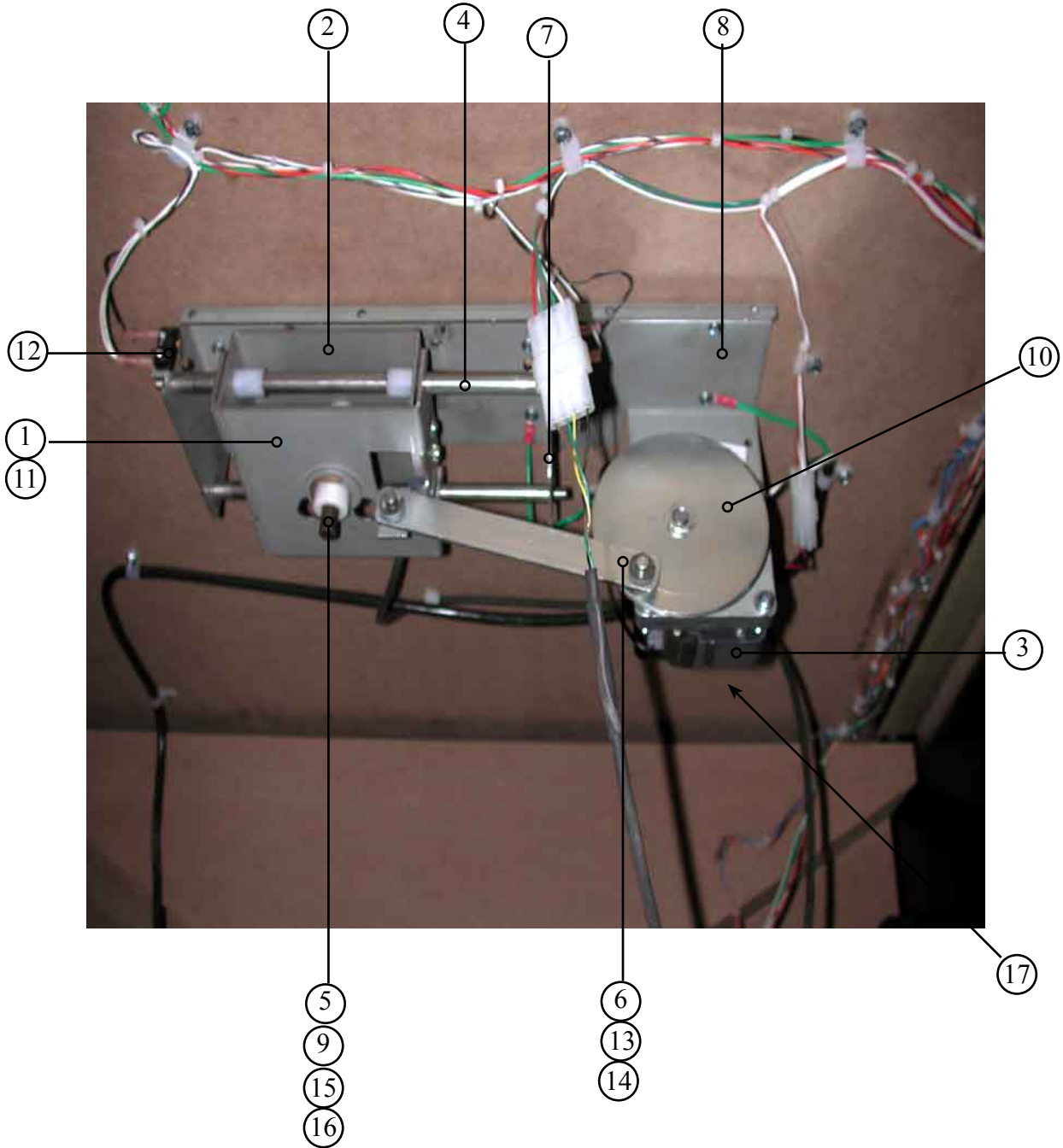

Car Motor Assy.

(P 2/3)

Item Number	Part Number	Description	Picture
1	998-1680	Plate Carriage Bottom	
2	999-1681	Plate Carriage Top	
3	999-1622	Motor	
4	999-1687	Rod 9in	
5	999-1682	Shaft Taxi Mover	
6	999-1683	Arm Bracket	
7	999-1685	Bracket S/A Car	
8	999-1684	Bracket Main Car Assy.	

Item Number	Part Number	Description	Picture
9	999-1686	Collar Shaft	
10	999-1688	Wheel Motor	
11	999-1689	Slide Spacer	
12	999-1631	Micro Switch Car Motor	
13	999-1690	Washer OD=13mm ID=6.75MM	
14	999-1692	E-Ring 13mm	
15	999-1691	Washer OD=19.25mm ID=9mm	
16	999-1693	E-Ring 25mm	
17	999-1621	Motor Fan	

Warranty

Your new Sega Product is covered for a period of 90 days from the date of shipment. This certifies that the Printed Circuit Boards, Power Supplies and Monitor are to be free of defects in workmanship or materials under normal operating conditions. This also certifies that all Interactive Control Assemblies are to be free from defects in workmanship and materials under normal operating conditions. No other product in this machine is hereby covered.

Sellers sole liability in the event a warranted part described above fails shall be, at its option, to replace or repair the defective part during the warranty period. For Warranty claims, contact your Sega Distributor.

Should the Seller determine, by inspection that the product was caused by Accident, Misuse, Neglect, Alteration, Improper Repair, Installation or Testing, the warranty offered will be null and void.

Under no circumstances is the Seller responsible for any loss of profits, loss of use, or other damages.

This shall be the exclusive written Warranty of the original purchaser expressed in lieu of all other warranties expressed or implied. Under no circumstance shall it extend beyond the period of time listed above.



SEGA AMUSEMENTS USA, INC.

45133 Industrial Drive
Fremont, CA 94538
(415) 701-6580 phone
(415) 701-6594 fax