

SOUTH PARK™ RALLY

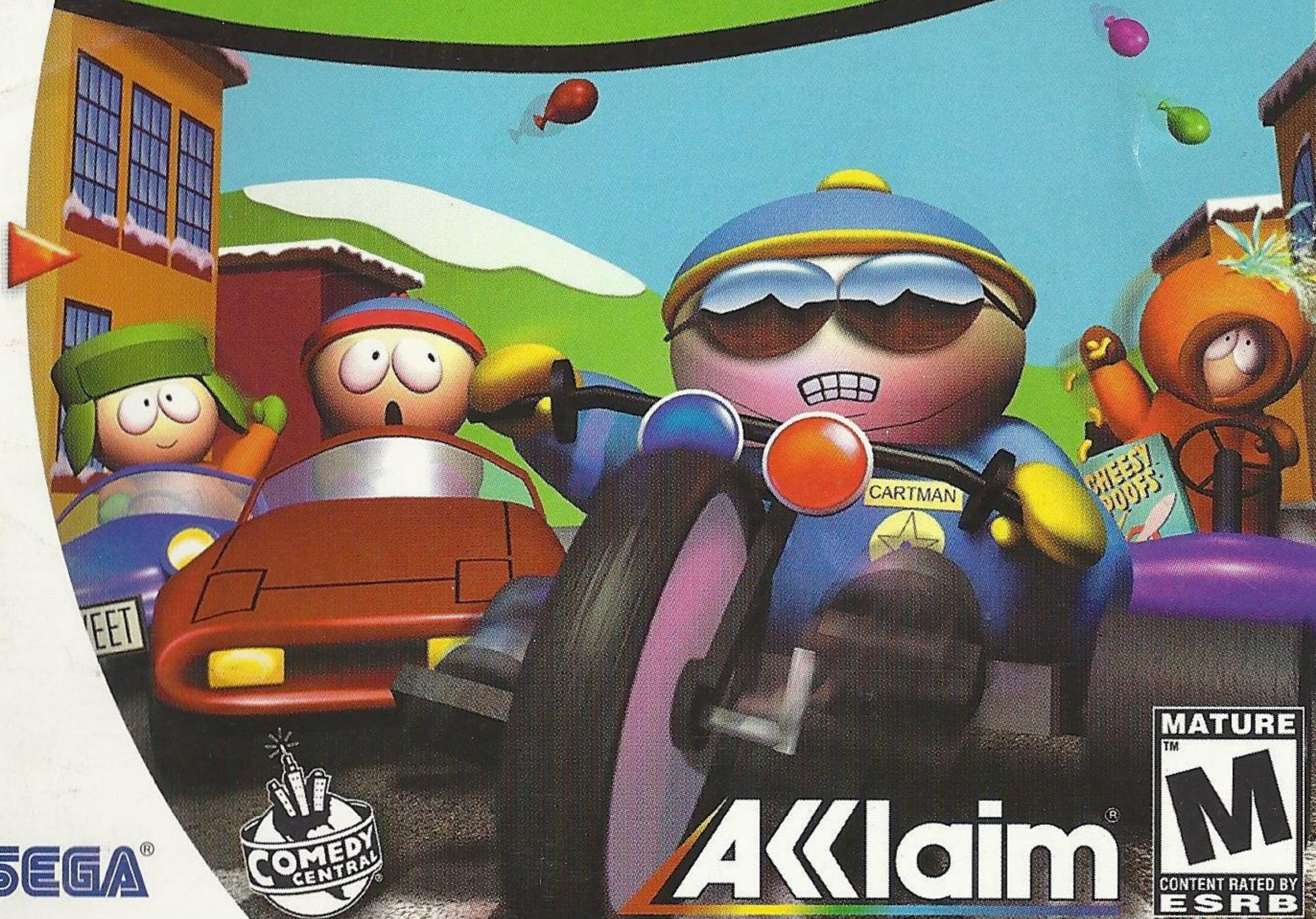

SEGA®



Akk!aim®



T-8116N

WARNINGS Read Before Using Your Sega Dreamcast Video Game System

CAUTION

Anyone who uses the Sega Dreamcast should read the operating manual for the software and console before operating them. A responsible adult should read these manuals together with any minors who will use the Sega Dreamcast before the minor uses it.

HEALTH AND EPILEPSY WARNING

Some small number of people are susceptible to epileptic seizures or loss of consciousness when exposed to certain flashing lights or light patterns that they encounter in everyday life, such as those in certain television images or video games. These seizures or loss of consciousness may occur even if the person has never had an epileptic seizure.

If you or anyone in your family has ever had symptoms related to epilepsy when exposed to flashing lights, consult your doctor prior to using Sega Dreamcast.

In all cases, parents should monitor the use of video games by their children. If any player experiences dizziness, blurred vision, eye or muscle twitches, loss of consciousness, disorientation, any involuntary movement or convulsion, **IMMEDIATELY DISCONTINUE USE AND CONSULT YOUR DOCTOR BEFORE RESUMING PLAY.**

To reduce the possibility of such symptoms, the operator must follow these safety precautions at all times when using Sega Dreamcast:

- Sit a minimum of 6.5 feet away from the television screen. This should be as far as the length of the controller cable.
- Do not play if you are tired or have not had much sleep.
- Make sure that the room in which you are playing has all the lights on and is well lit.
- Stop playing video games for at least ten to twenty minutes per hour. This will rest your eyes, neck, arms and fingers so that you can continue comfortably playing the game in the future.

OPERATING PRECAUTIONS

To prevent personal injury, property damage or malfunction:

- Before removing disc, be sure it has stopped spinning.
- The Sega Dreamcast GD-ROM disc is intended for use exclusively on the Sega Dreamcast video game system. Do not use this disc in anything other than a Sega Dreamcast console, especially not in a CD player.
- Do not allow fingerprints or dirt on either side of the disc.
- Avoid bending the disc. Do not touch, smudge or scratch its surface.
- Do not modify or enlarge the center hole of the disc or use a disc that is cracked, modified or repaired with adhesive tape.
- Do not write on or apply anything to either side of the disc.
- Store the disc in its original case and do not expose it to high temperature and humidity.
- Do not leave the disc in direct sunlight or near a radiator or other source of heat.
- Use lens cleaner and a soft dry cloth to clean disc, wiping gently from the center to the edge. Never use chemicals such as benzene and paint thinner to clean disc.

PROJECTION TELEVISION WARNING

Still pictures or images may cause permanent picture tube damage or mark the phosphor of the CRT. Avoid repeated or extended use of video games on large-screen projection televisions.

SEGA DREAMCAST VIDEO GAME USE

This GD-ROM can only be used with the Sega Dreamcast video game system. Do not attempt to play this GD-ROM on any other CD player; doing so may damage the headphones and/or speakers. This game is licensed for home play on the Sega Dreamcast video game system only. Unauthorized copying, reproduction, rental, public performance of this game is a violation of applicable laws. The characters and events portrayed in this game are purely fictional. Any similarity to other persons, living or dead, is purely coincidental.

TABLE OF CONTENTS

STARTING THE GAME	2
INTRODUCTION	4
MENUS	4
OPTIONS	4
DEFAULT CONTROLS	7
THE SCREEN	8
CHECKPOINTS/OBJECTIVES	8
GAME MODES	9
CHAMPIONSHIP	11
MINI CHAMPIONSHIP	16
ARCADE RACE	16
MULTIPLAYER	17
ACTION ITEMS	17
HINTS AND TIPS	22

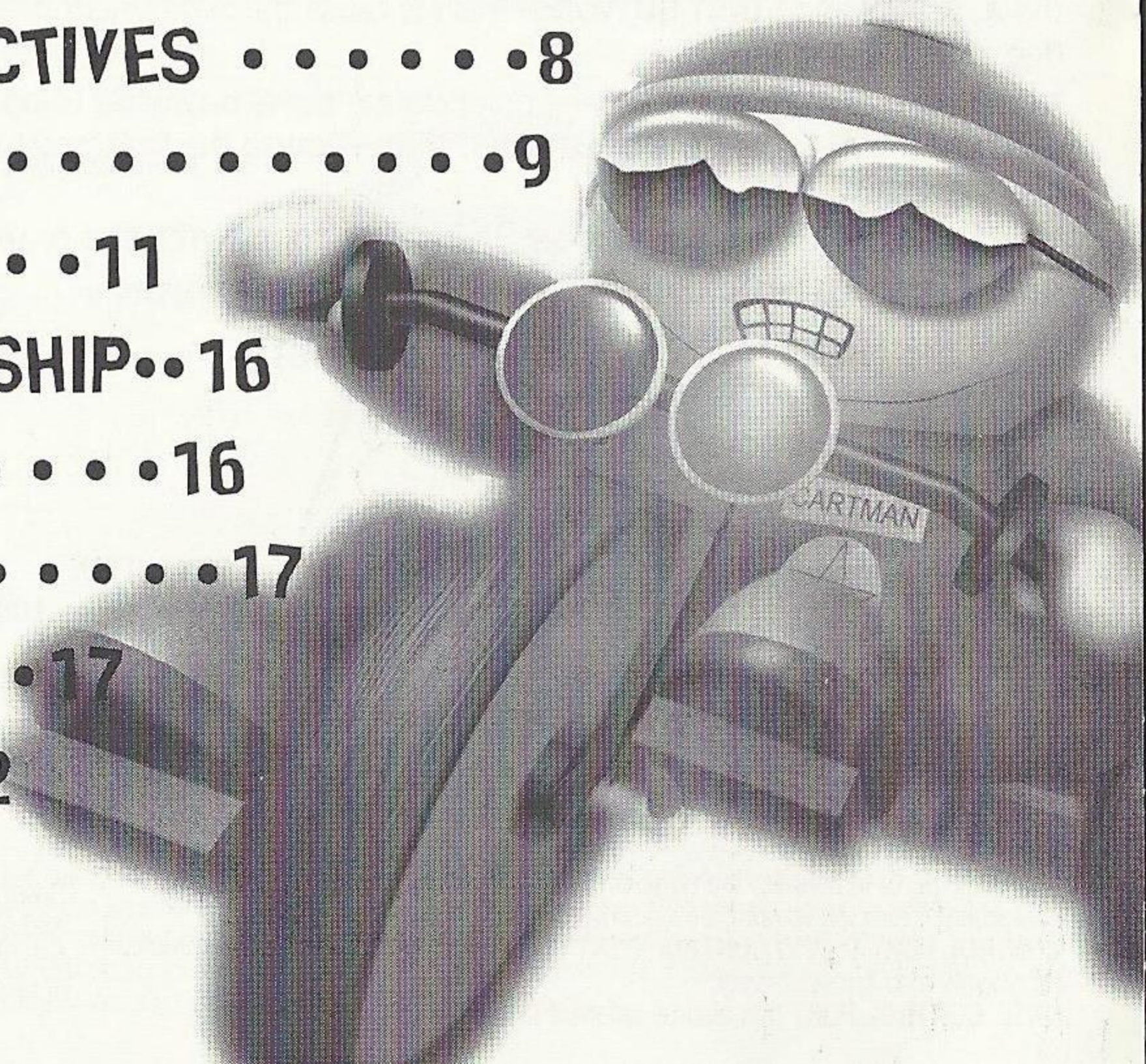

STARTING THE GAME

1. Insert your **SOUTH PARK RALLY**™ Sega Dreamcast™ Specific Disc into your Sega Dreamcast console.

2. Plug your Sega Dreamcast Controller into Controller Port A.

NOTE: SOUTH PARK RALLY is a 1-4 player game*. Before turning the Sega Dreamcast power ON, connect the controller or other peripheral equipment into the control ports of the Sega Dreamcast.

3. Switch on the power to your Sega Dreamcast Unit.

4. You will be prompted to select a VMU on which to save your progress in the game. Insert the VMU into Port A, Slot 1 of your Sega Dreamcast Controller. Each saved game requires 8 blocks of memory. If you do not have a VMU inserted or it does not have adequate blocks to save the game data, you will be alerted but may continue playing.

While saving a game file, never turn OFF the Sega Dreamcast power, remove the memory card or disconnect the controller.

To return to the title screen at any point during game play while using the Dreamcast Controller press and hold the **A, B, X, Y** and **START BUTTONS**. This will cause the Sega Dreamcast to soft-reset the software and display the title screen.

To return to the title screen at any point during game play while using the Race Controller, simultaneously press and hold the **A, B** and **START BUTTONS**. This will cause the Dreamcast to soft-reset the software and display the title screen.

*Purchase additional controllers (sold separately) to play with two or more people.

Operation with incompatible controllers is not guaranteed.

SEGA DREAMCAST HARDWARE UNIT

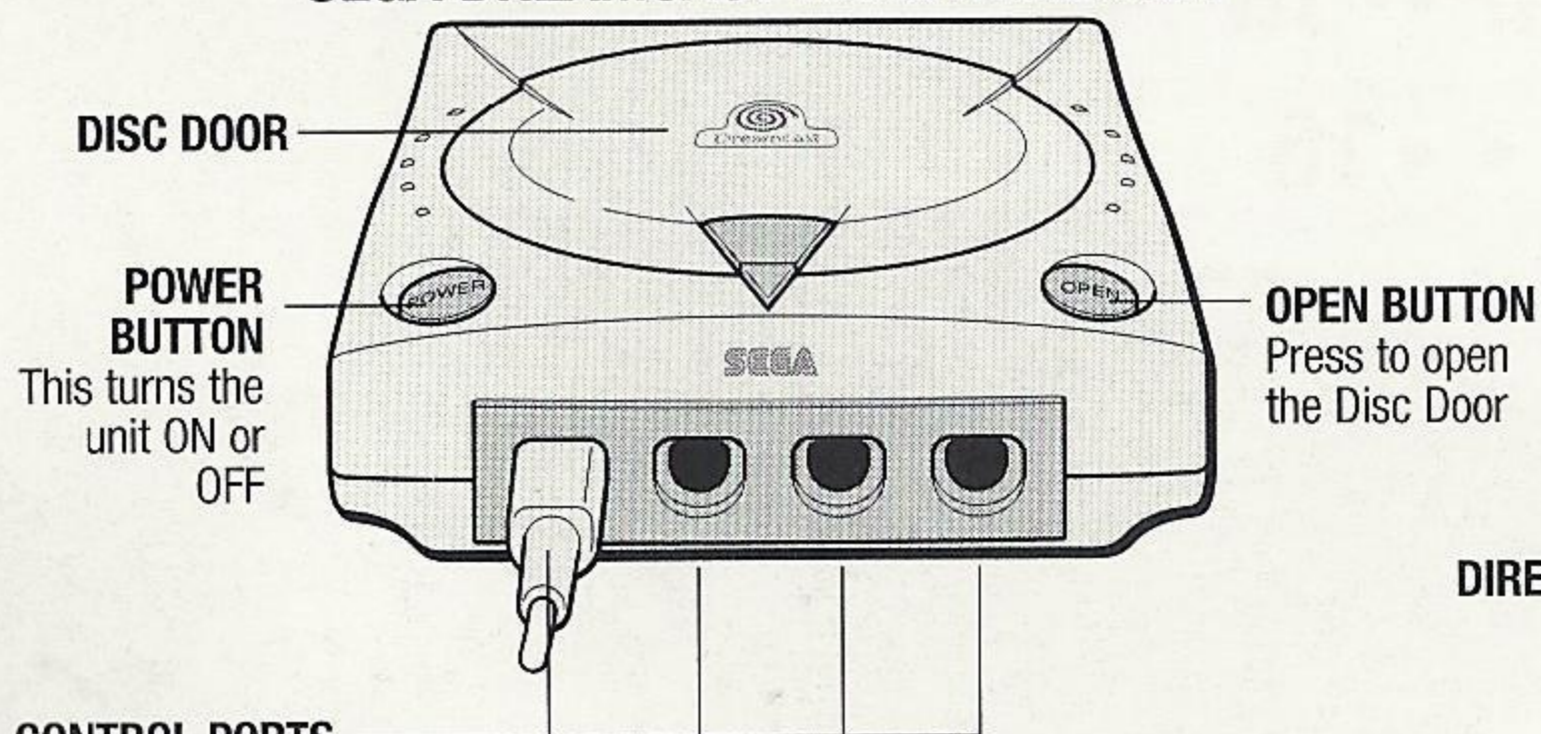

CONTROL PORTS

Use these ports to connect the Sega Dreamcast Controller or other peripheral equipment. From left to right are **CONTROL PORT A, CONTROL PORT B, CONTROL PORT C, AND CONTROL PORT D**. Use each port to connect controllers for players 1 to 4 respectively.

NOTE: CONTROL PORT can also be referred to as **PORT**.

VISUAL MEMORY UNIT (VMU)

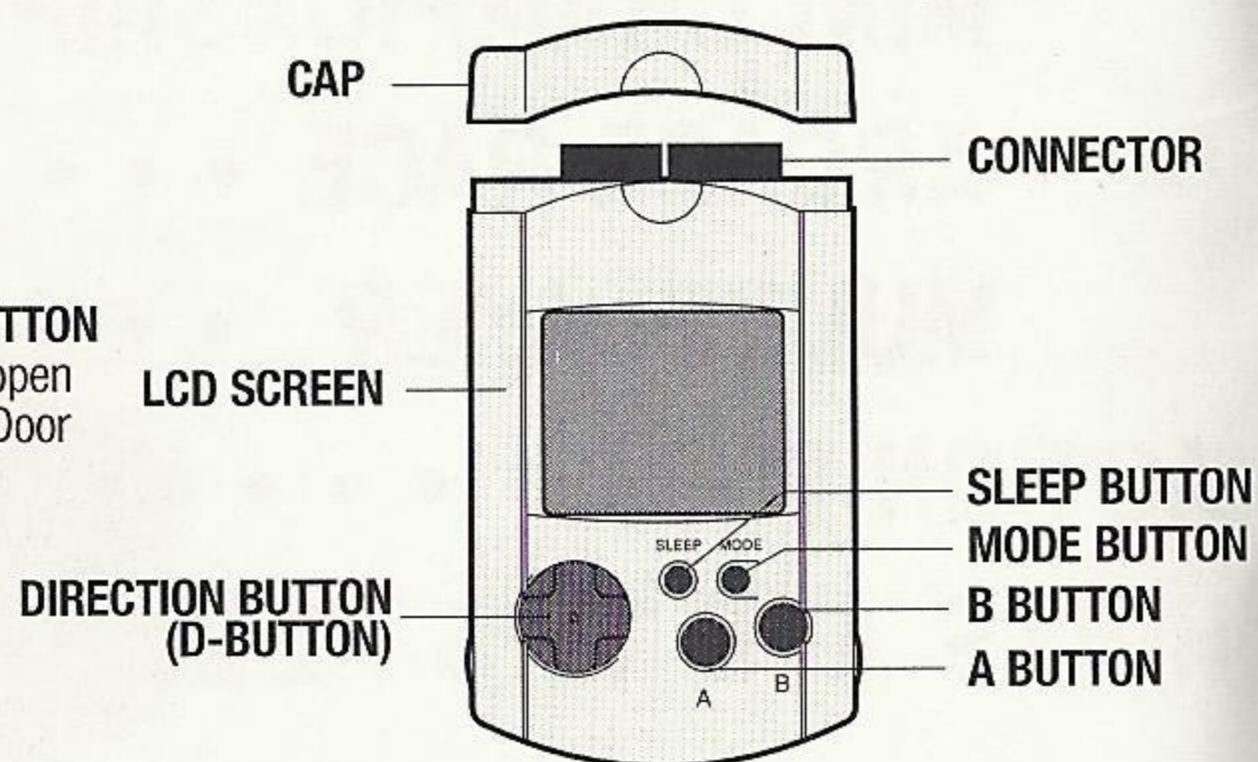

Never disconnect the VMU / VMs while performing a battle or exchanging data when connected to another VMU/VM. Also note that leaving two VMU / VMs connected for a long period of time will considerably shorten the life of the batteries.

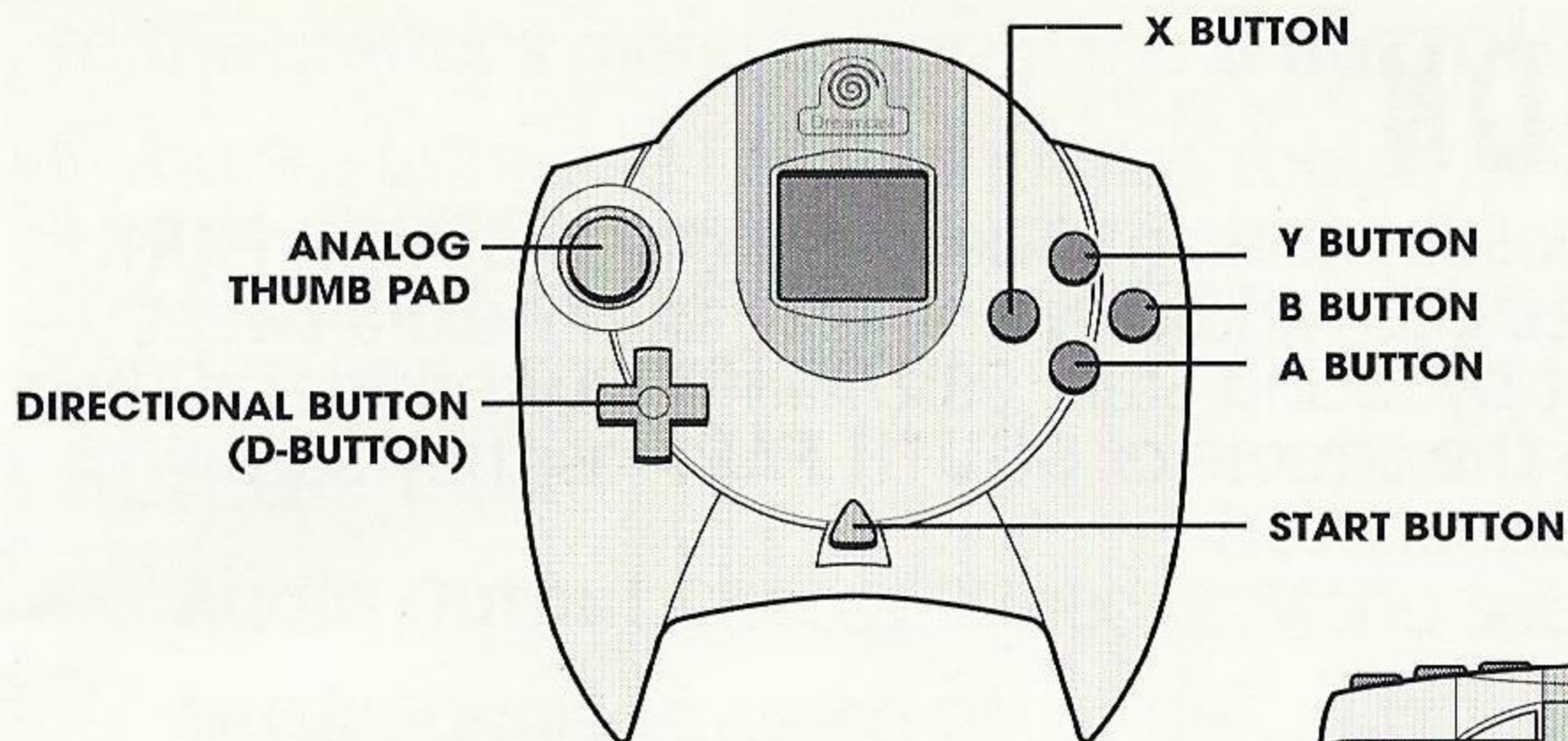

Never touch the Analog Thumb Pad or Triggers L/R while turning the Sega Dreamcast power ON. Doing so may disrupt the controller initialization procedure and result in malfunction. Operation with incompatible controllers is not guaranteed.

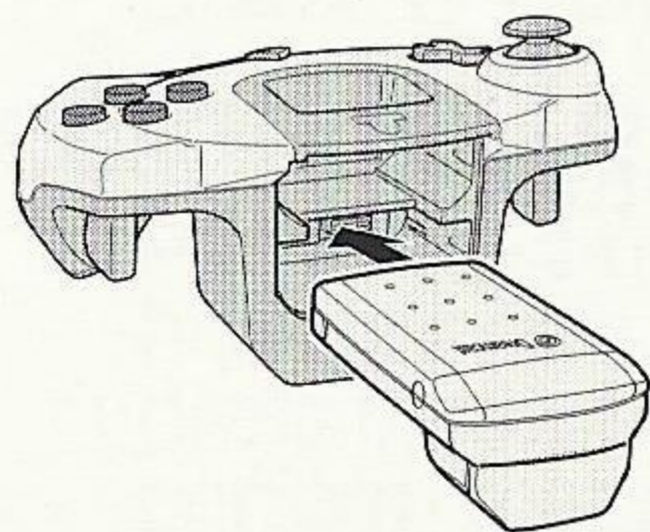
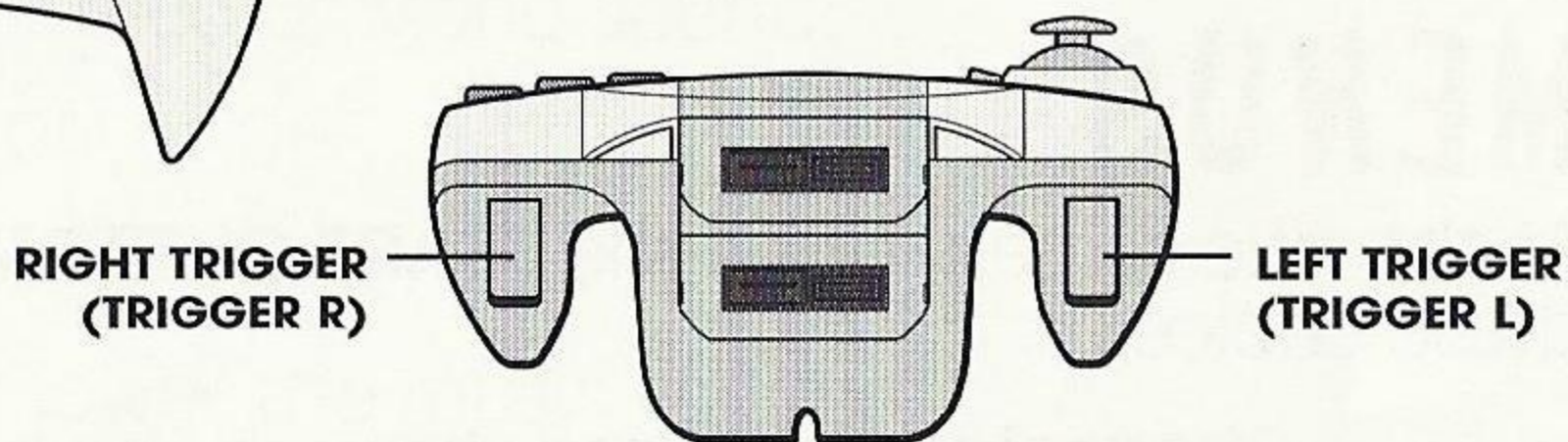

When the Jump Pack / Vibration Pack is inserted into Expansion Socket 1 of the Sega Dreamcast Controller, the Jump Pack / Vibration Pack does not lock into place and may fall out during game play or otherwise inhibit game operation.

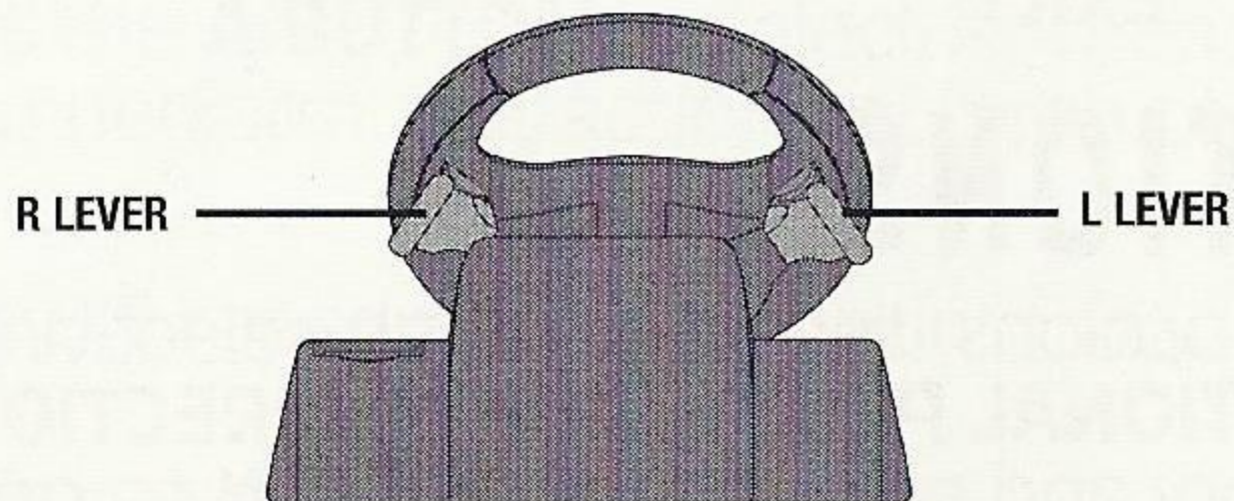
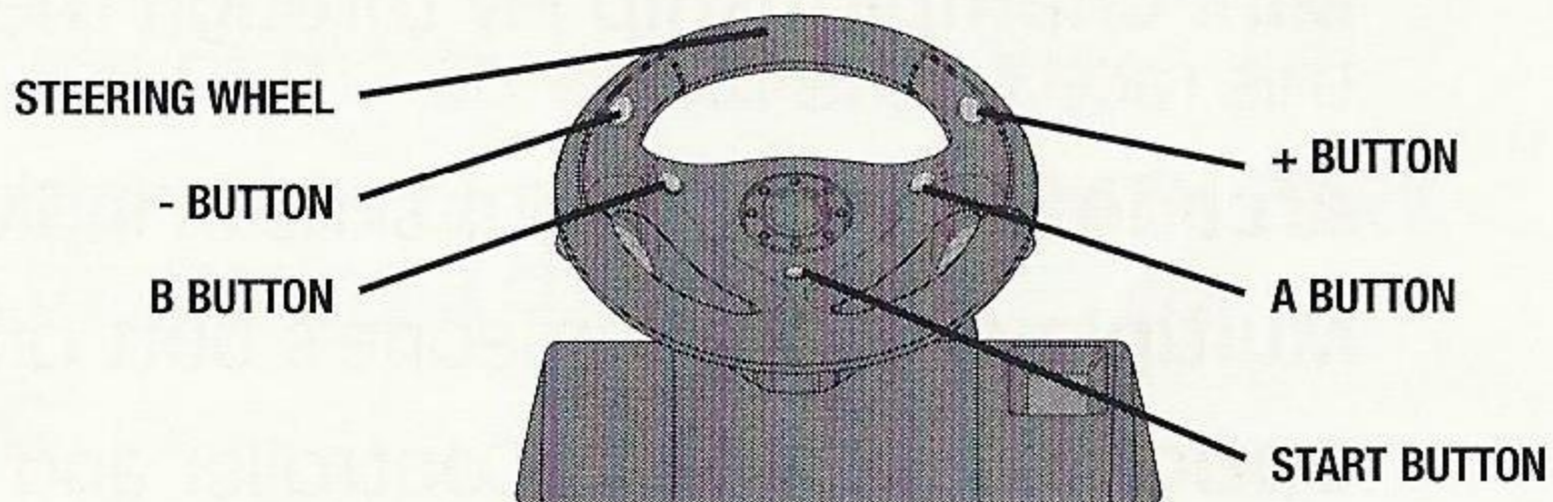

When using the Race Controller, never touch the steering wheel or left and right levers when turning the Sega Dreamcast power ON. Doing so may disrupt the initialization procedure and result in malfunction if readjustment is not properly carried out via the Options menu. If the handle or levers are accidentally moved while turning the power ON, immediately turn the power OFF and ON again making sure not to touch the Race Controller.

INTRODUCTION

Don't you just love the holiday season? The residents of **SOUTH PARK** do! And to commemorate each and every holiday, they hold a sweet kart race. Get in the spirit by racing Stan, Cartman, Kyle, Kenny and their fellow residents through the streets of **SOUTH PARK** as they battle for truth, justice and some underwear!

MENUS

At the title screen, press the **START BUTTON**. You will see a menu with these choices:

Championship Race through the holidays in **SOUTH PARK!**

Mini Championship Fly through the streets of South Park in this race to the finish!

Arcade Race Hone your skills in individual races!

Multiplayer Blow someone's butt off!

Options Audio/Video/Controller and Game Setups

Exit

OPTIONS

To set options, toggle through selections with the **ANALOG DIRECTIONAL PAD** or **DIGITAL DIRECTIONAL PAD** to highlight an option category and press the **A BUTTON** to go to that menu. On the menu, highlight an option and cycle through settings with the **ANALOG THUMB PAD** or **DIRECTIONAL BUTTON**. When done, highlight **EXIT** and press the **A BUTTON** to return



to the previous menu (or press the **B BUTTON**).

If you are using the Race Controller, toggle through selections with the **+** and **-** **BUTTONS** and make your selections using the **A BUTTON**. Turn the **STEERING WHEEL LEFT** or **RIGHT** to cycle through settings and confirm using the **A BUTTON**.

AUDIO

Audio Output Choose Stereo or Mono sound.

Music Toggle between ON or OFF.

Music Test Pick a delightful ditty from our playlist.

Music Volume Raise or lower the music volume.

Effects Volume Raise or lower the sound effect volume.

Effects Test Try out some of the great sound effects!

Speech Test Listen to the voices of those nutty **SOUTH PARK** characters! Unlock this by earning a cheat code.

CONTROLLER CONFIG

Players 1-4 Use this option to set controls to your liking. Simply highlight an action and press the **A BUTTON** to select it. Then press the button you wish to perform that action you wish to perform that action.

Vibration Turn the vibration ON for some earth shakin' fun!

GAME OPTIONS

Pickups Turn pick ups ON or OFF.

Best Times View your best Mini Championship times for each race and in total.

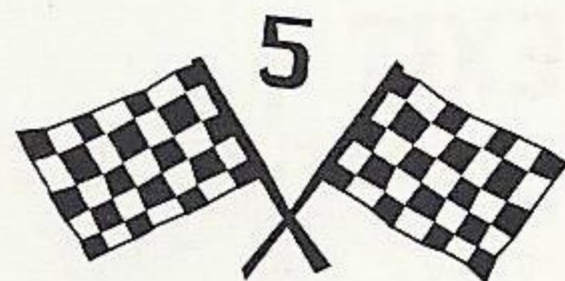

Random Checkpoints Set to ON (checkpoints appear in different spots) or OFF (checkpoints always appear in the same place). Some races are not affected. Unlock this by earning a cheat code.

Number of Arcade CPU Cars Choose how many computer controlled opponents you'll face, from 1-5.

Multiplayer CPU Cars When ON, CPU controlled cars join the fun in multiplayer races.

CPU Character Type Choose to play against different characters. Choices are Random, Kids #1, Kids #2, Adults #1, Adult #2 and Cameo.

2P Splitscreen In a 2 player game, choose to play with the screen split horizontally or vertically.

Exit Return to the main Options screen.

CHEAT SHEET

View your unlocked items and see what's left to accomplish!
Available when unlocked.

LOAD GAME

Load unlocked characters, tracks, races, options and controller configs.

SAVE GAME

Save unlocked characters, tracks, races, options and controller configs.

CREDITS

View a list of the talented and demented people who brought you this game.

EXIT

Return to the main menu.

DEFAULT CONTROLS

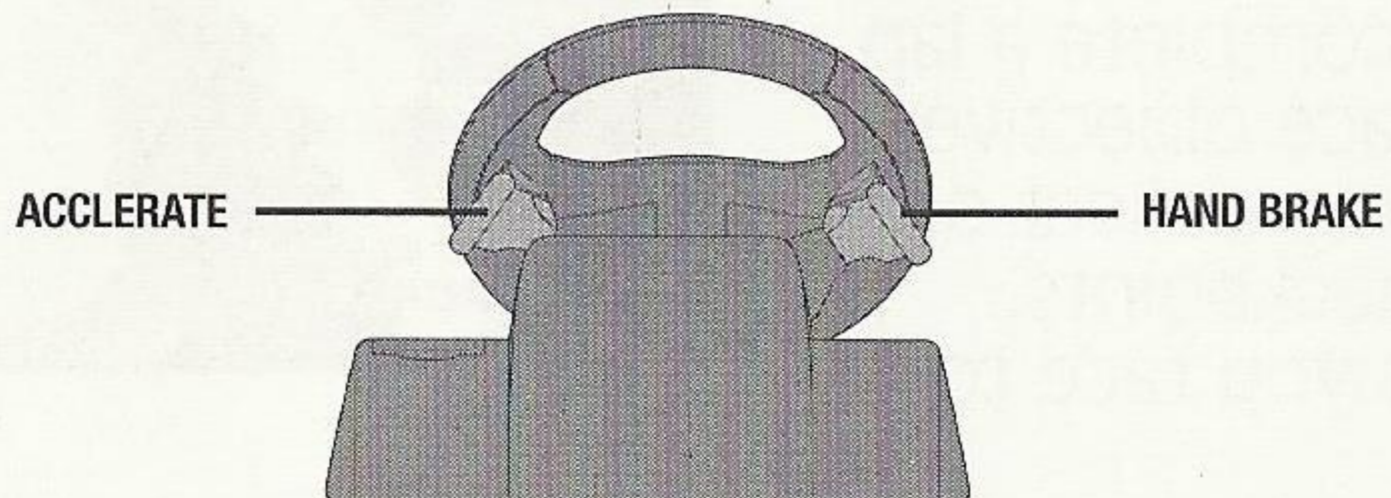
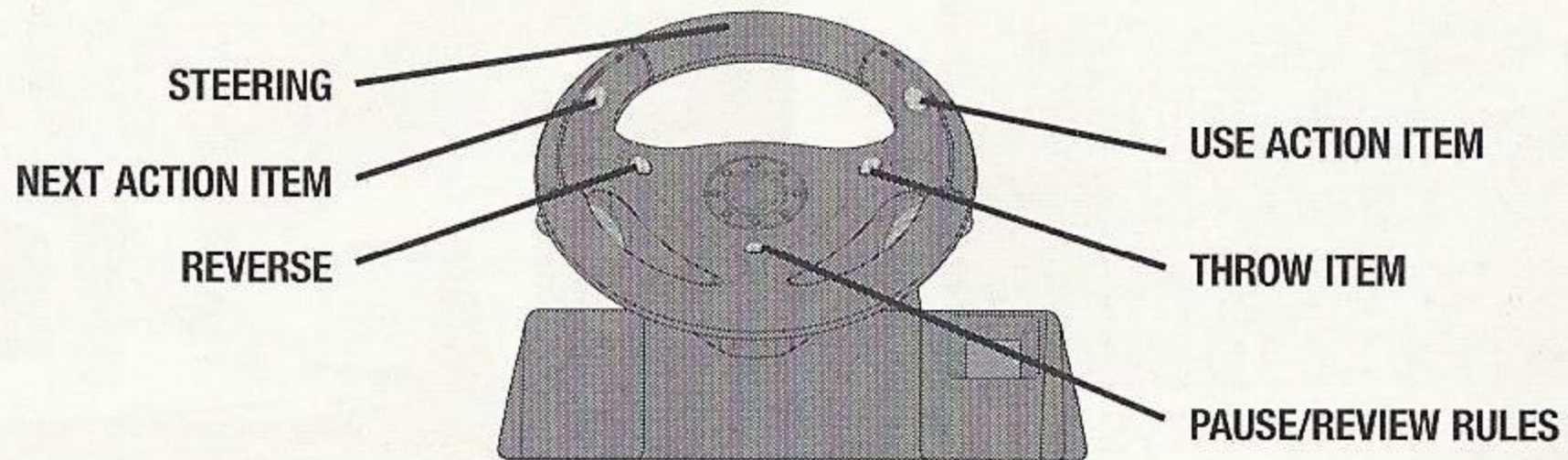
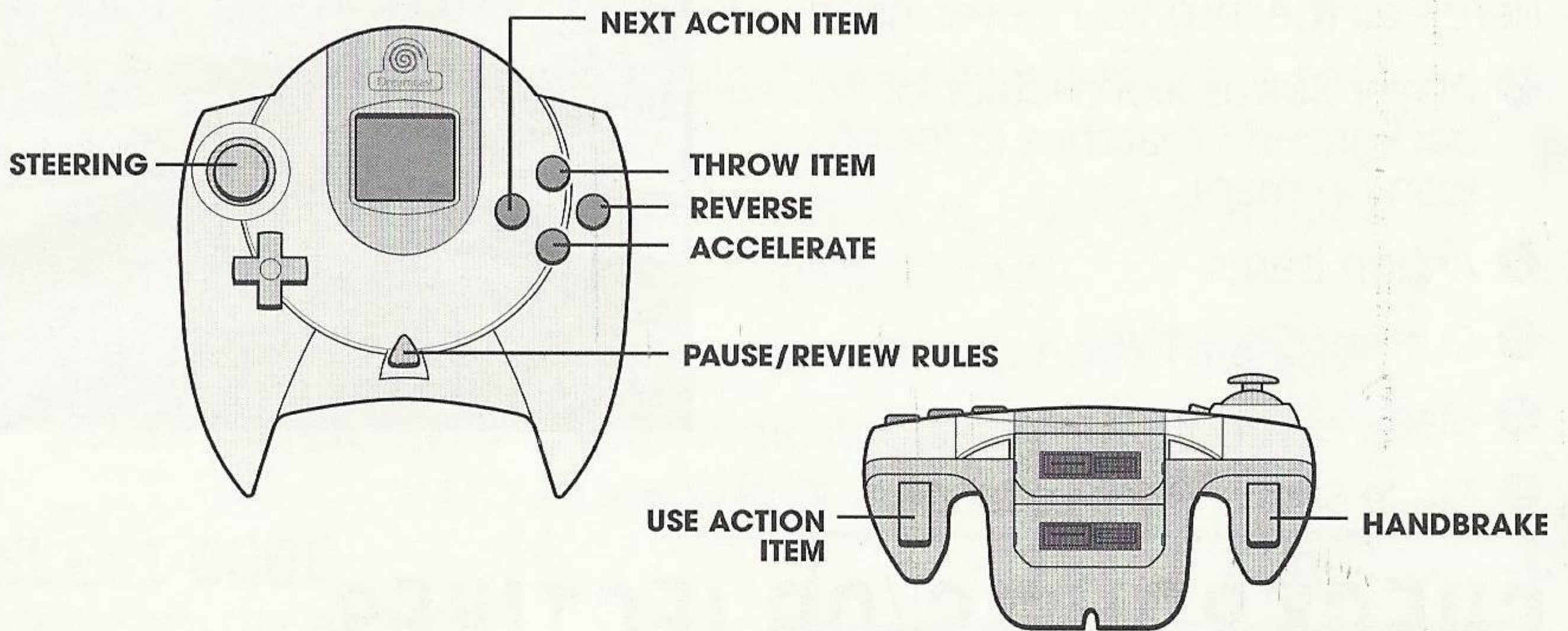

THE SCREEN

Here's all the info you'll ever need:

- 1 Player Status Icons (color of background matches color of icon on map)
- 2 Action Items
- 3 Current Objective
- 4 Map
- 5 Circle Shows Puck Location

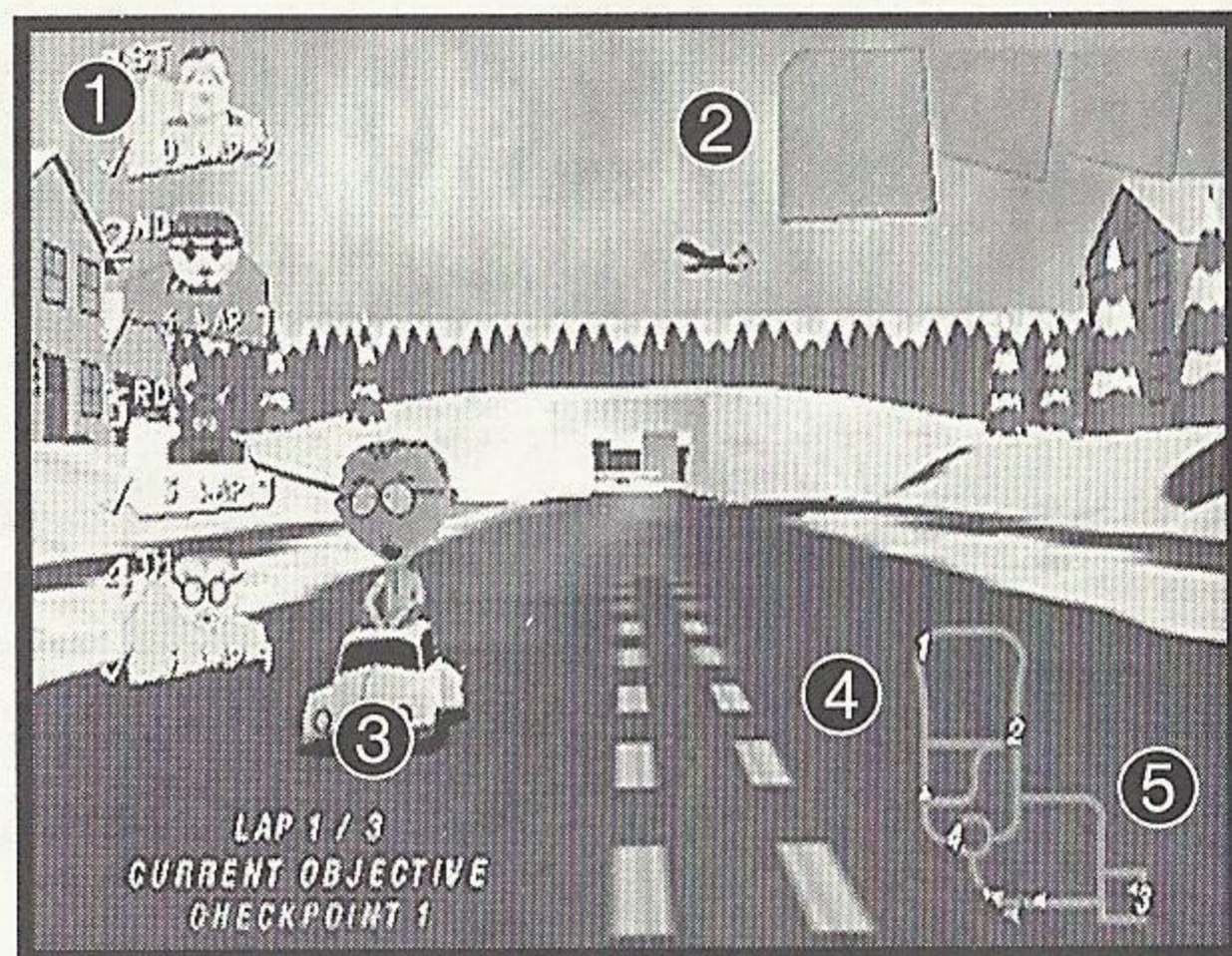

CHECKPOINTS/OBJECTIVES

During your scenic tour of **SOUTH PARK**, you will notice large numbered, colored checkpoints. If you check the objectives for each race, some will require you to run over these checkpoints to complete a lap. For example, Rally Days #1 asks that you run over 4 checkpoints in numerical order to complete a lap. Additionally, other race objectives require you to pick up, collect or drop off items at checkpoints. Keep this in mind as you race to the finish!

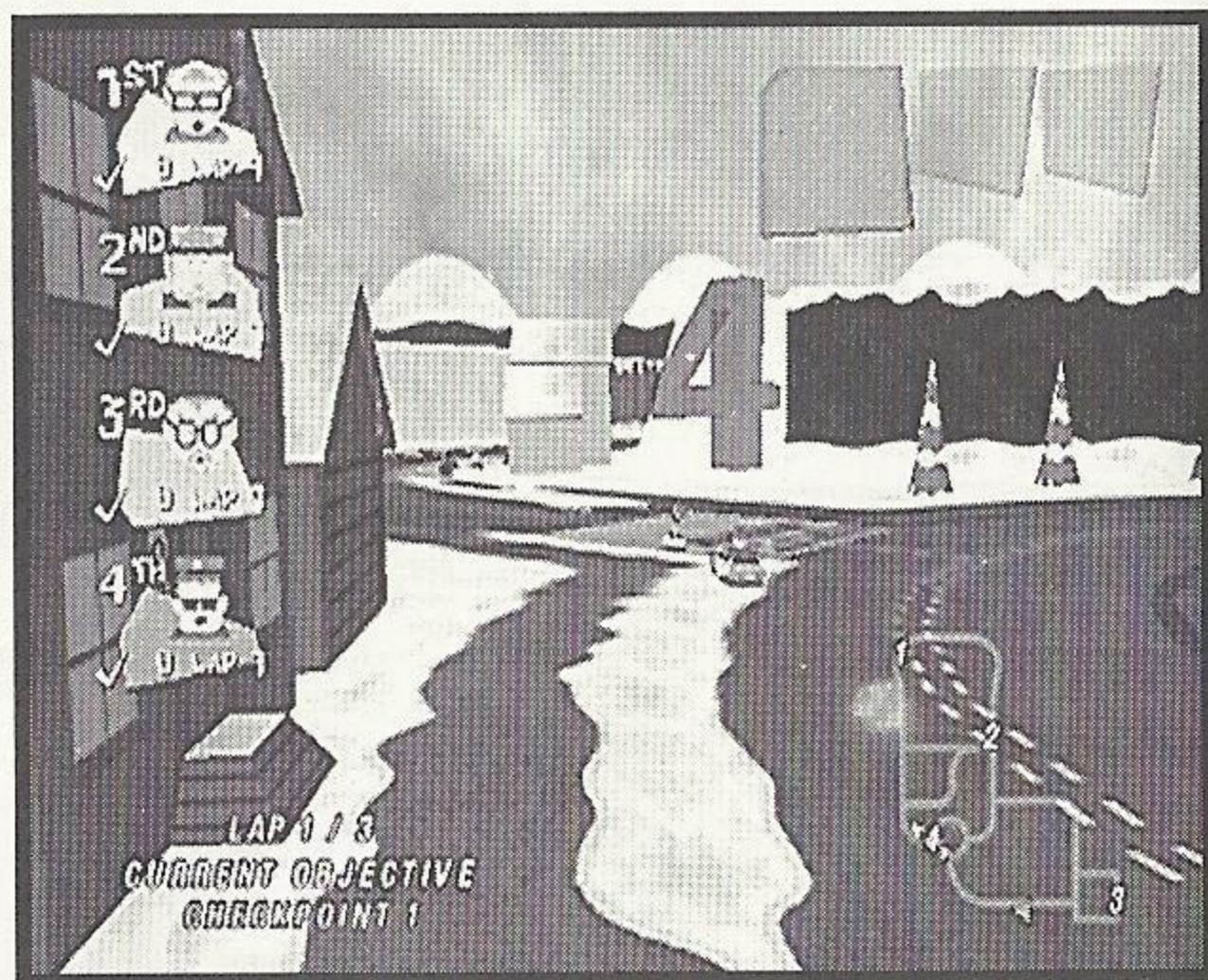

GAME MODES

CHOOSE FROM FOUR MODES:

CHAMPIONSHIP Compete against your neighbors in the spirit of the holiday!

MINI CHAMPIONSHIP Be the first to race to the finish in this no-holds-barred contest!

ARCADE RACE Select individual scenarios to hone your skills!

MULTIPLAYER You and your compatriots can duke it out in any unlocked scenario or in an Ass Battle!

SELECT DUDE

Move using the **ANALOG DIRECTIONAL PAD** or **DIGITAL DIRECTIONAL PAD** to choose which dude will carry you to victory and press the **A BUTTON** to confirm your selection.

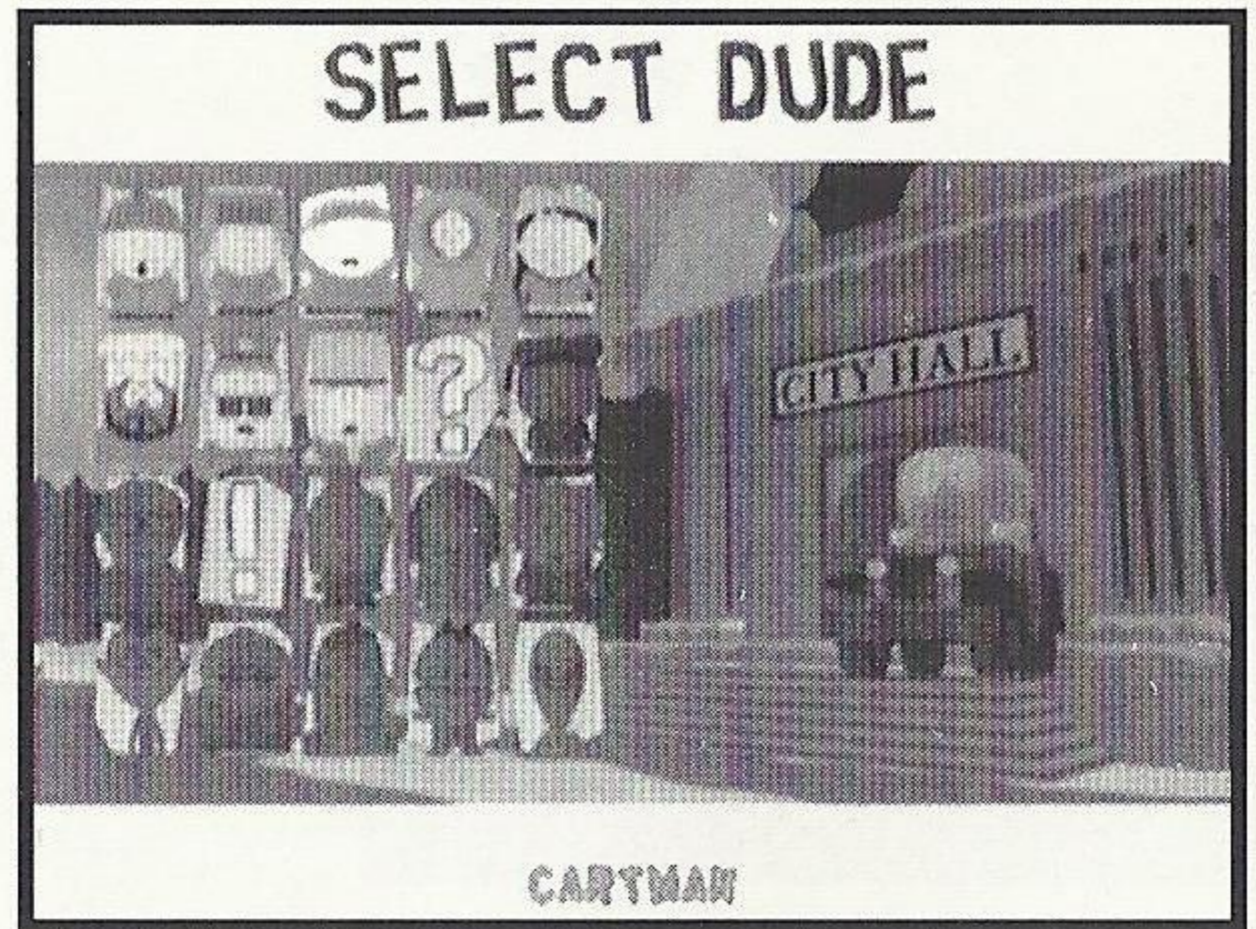

WHEN YOU START A NEW GAME, THE FOLLOWING CHARACTERS ARE AVAILABLE:

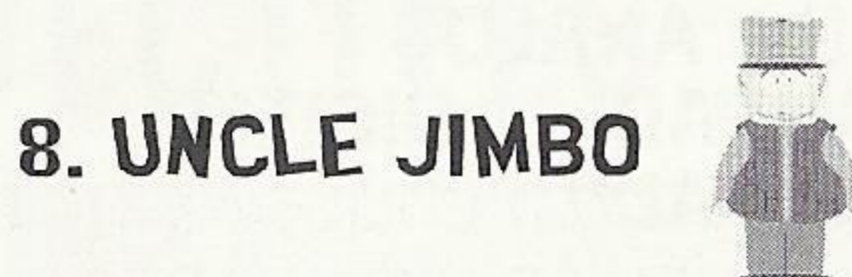
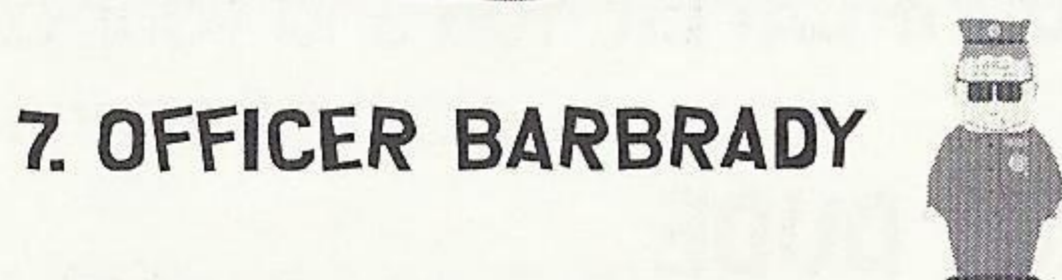
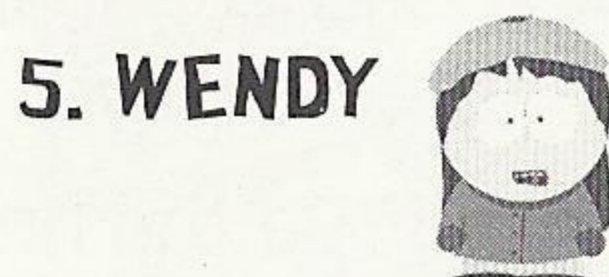

Other cars can be unlocked in Championship. Some by merely winning, others for harder and more daring stunts.



GO ALREADY!

OK...you've chosen Championship and chosen a car. In Championship, that's all you need to do—the game automatically chooses the track you'll compete on. In all other modes, however, you get to select the track of your choice. Do so by cycling through the tracks with the **ANALOG DIRECTIONAL PAD** or **DIGITAL DIRECTIONAL PAD**, then pressing the **A BUTTON** to select it.

CHAMPIONSHIP

Compete against your fellow **SOUTH PARK** natives with love on Valentine's Day! With pride on the Fourth of July! With cleaning products during Spring Cleaning! To help you succeed in your goal, here is an outline of the tasks ahead.

RALLY DAYS #1

This is a race to the finish! Cross all four checkpoints in numerical order. This is counted as a lap. Complete 3 laps to complete this race.

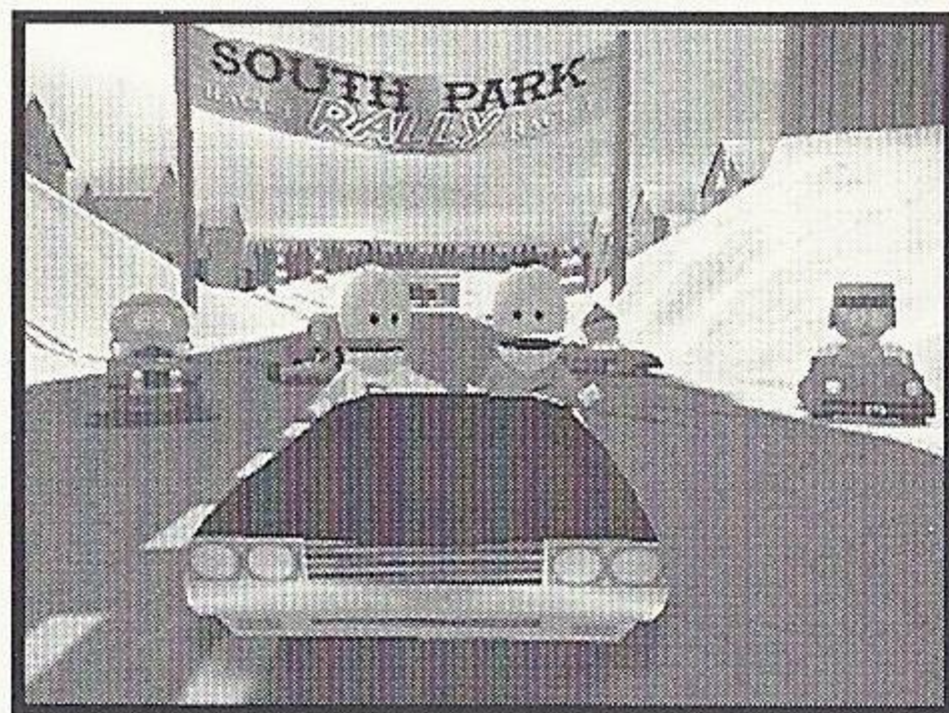

RALLY DAYS #2

Find and collect the trophy. Race to the checkpoint flashing on the screen. The first player to cross checkpoint four with the trophy after all checkpoints have been crossed in order is the winner.

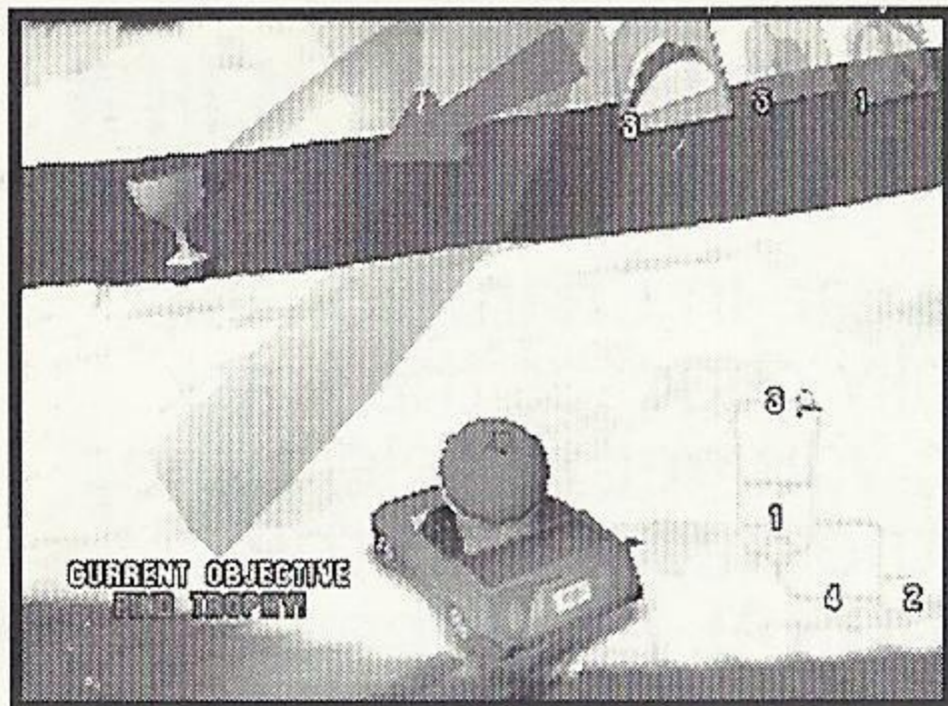

COW DAYS

Everyone has Mad Cow Disease and there's only enough antidote for one of you! Hold on to the cure until you are disease-free to win!

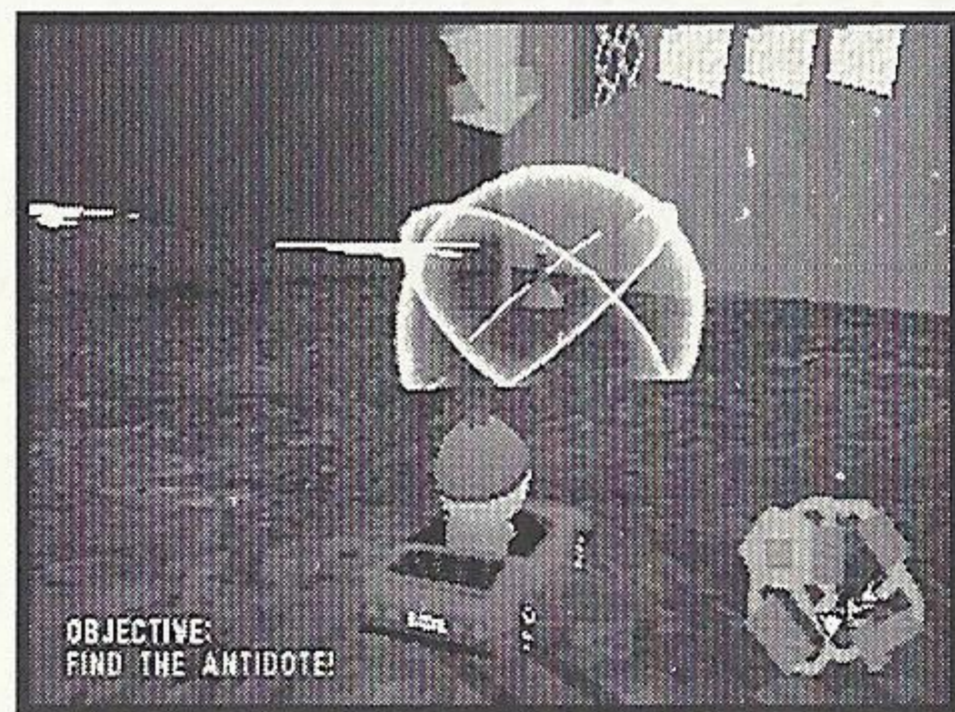

VALENTINE'S DAY

Find the bow and arrow. Shoot your fellow man (or woman) with a love arrow (you'll know they've been shot because their indicator arrow will disappear). Be the first to shoot them all to come up roses in this event.

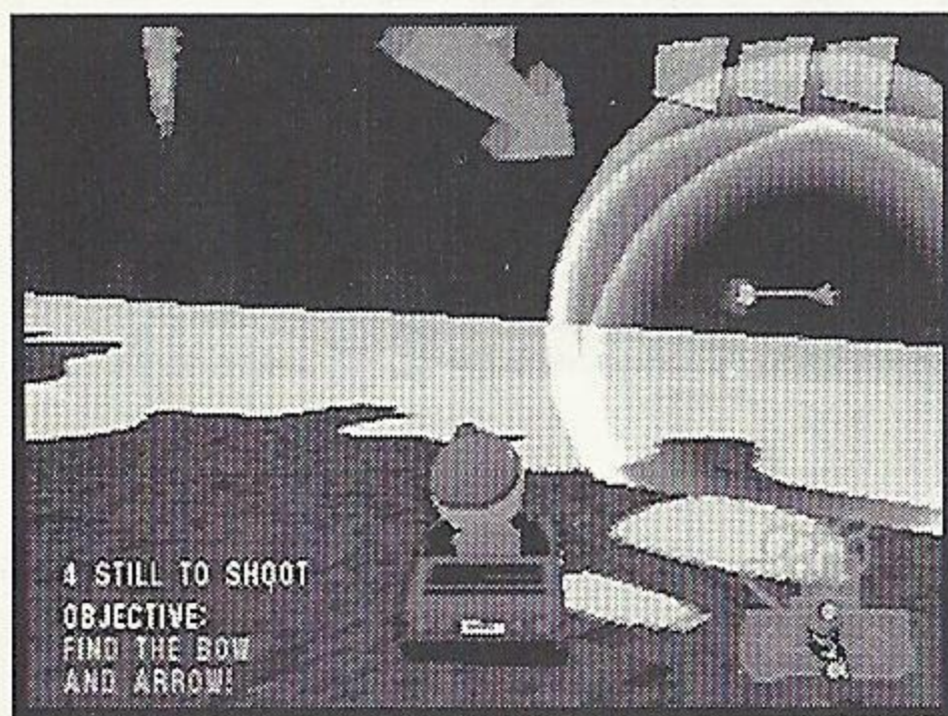

From: _____

Check here if this is a

- | | | |
|--|--|--|
| 13-1 <input type="checkbox"/> Boys' Life | 13-10 <input type="checkbox"/> Marvel Comics | 13-20 <input type="checkbox"/> Slam |
| 13-2 <input type="checkbox"/> Computer
Gaming World | 13-11 <input type="checkbox"/> Maxim | 13-21 <input type="checkbox"/> The Source |
| 13-3 <input type="checkbox"/> DC Comics | 13-12 <input type="checkbox"/> NEXT Generation | 13-22 <input type="checkbox"/> Spin |
| 13-4 <input type="checkbox"/> Electronic
Gaming Monthly | 13-13 <input type="checkbox"/> Nintendo Power | 13-23 <input type="checkbox"/> Sports Illustrated |
| 13-5 <input type="checkbox"/> Expert Gamer | 13-14 <input type="checkbox"/> Official Sega
Dreamcast Magazine | 13-24 <input type="checkbox"/> S.I. for Kids |
| 13-6 <input type="checkbox"/> Game Informer | 13-15 <input type="checkbox"/> PC Gamer | 13-25 <input type="checkbox"/> Stuff |
| 13-7 <input type="checkbox"/> Game Pro | 13-16 <input type="checkbox"/> PS Extreme | 13-26 <input type="checkbox"/> Unofficial Sega
Dreamcast Magazine |
| | 13-17 <input type="checkbox"/> P.S.M. | 13-27 <input type="checkbox"/> Wired |

FIRST
CLASS
POSTAGE
HERE

new address.

WARRANTY REGISTRATION
ACCLAIM ENTERTAINMENT INC
ONE ACCLAIM PLAZA
GLEN COVE NY 11542-9007

**FILL OUT
AND WIN!**
see back for details



SPRING CLEANING

Grab a pair of underpants and cross the checkpoints three times in numerical order. Be warned! There aren't enough undergarments for all of the racers so hold on to your shorts!

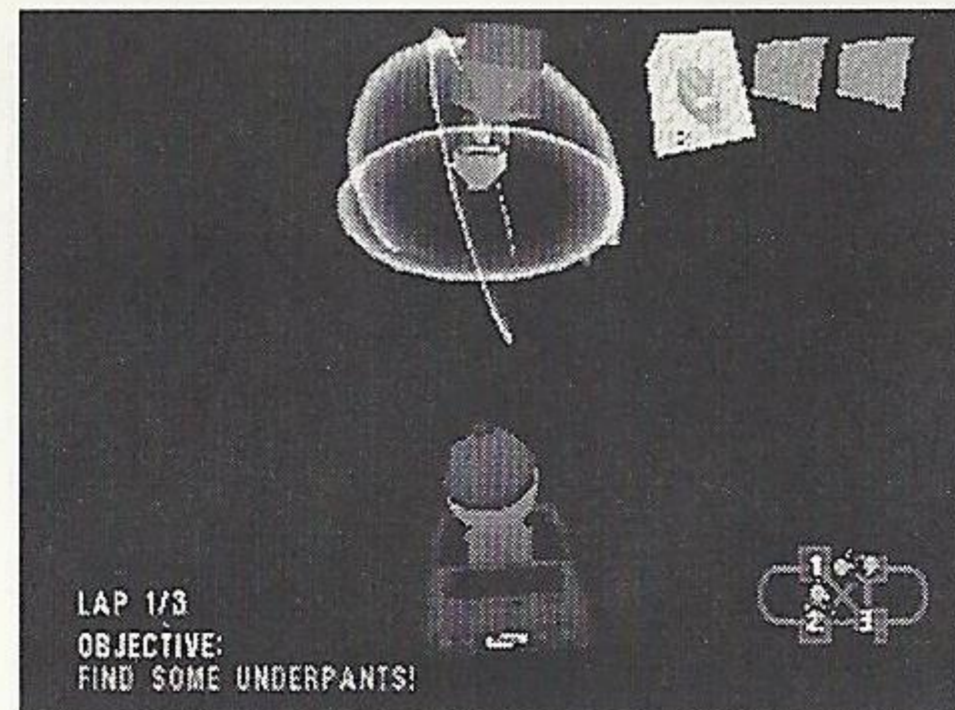

READ-A-BOOK DAY

Chicken Lover has been pardoned to promote literacy. While he's out, you must protect the chickens! Collect up to 4 chickens and deposit them at the drop-off point near the Police Station. Bump or shoot opponents to grab their chickens. The first contestant to save 10 chickens rules!



EASTER

The Easter Bunny has dropped **SOUTH PARK**'s eggs all over the mountain. Be the first to collect 20 Easter eggs to win. Luckily, your fellow racers can't steal your eggs in this race!



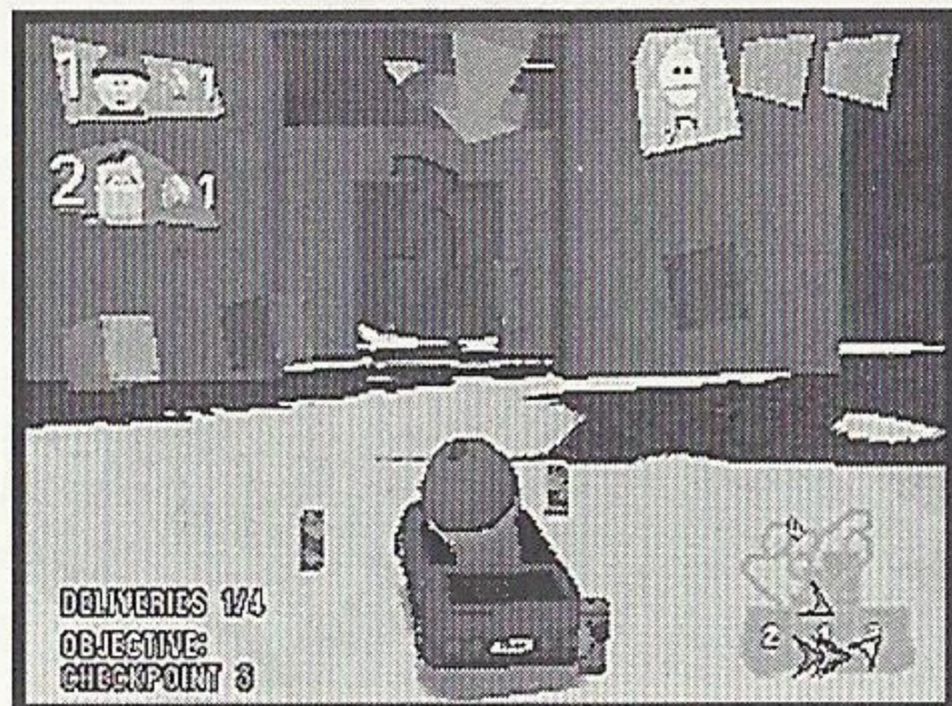

BIG GAY AL'S BIG GAY PINK LEMONADE

Each table will, randomly, request a glass of that cool refreshing drink. Be the first to deliver your 4 glasses of pink lemonade to the correct table to win.

MEMORIAL DAY

Collect the ultra-sophisticated laser device and charge it up on all four checkpoints. Cross all four of these checkpoints with the laser in-hand to win!

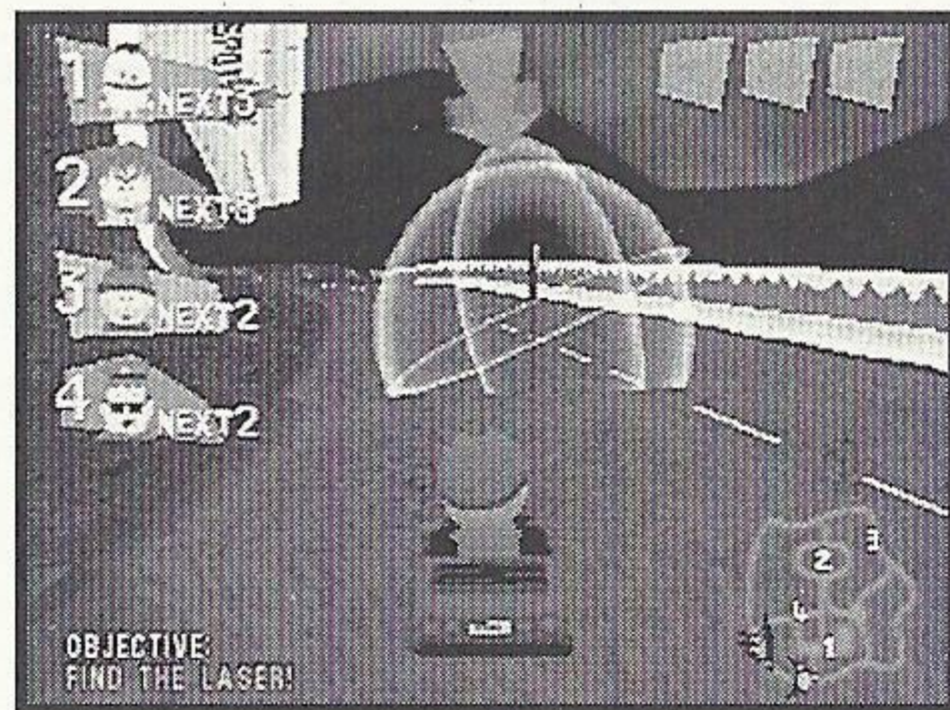

FOURTH OF JULY

Race over the checkpoints in numerical order. When all four checkpoints have been activated, you've completed a lap. The first player to complete 3 laps is the winner!

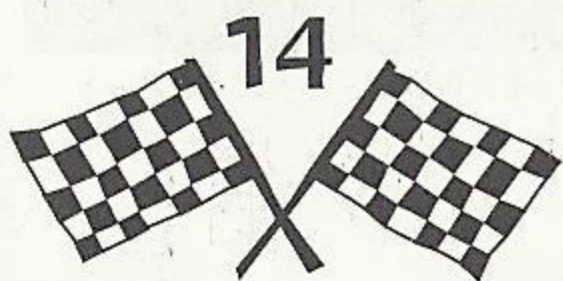

HALLOWEEN

Grab up to 4 candies at a time and take them to the candy check. Drop-off the most candies before curfew to win!

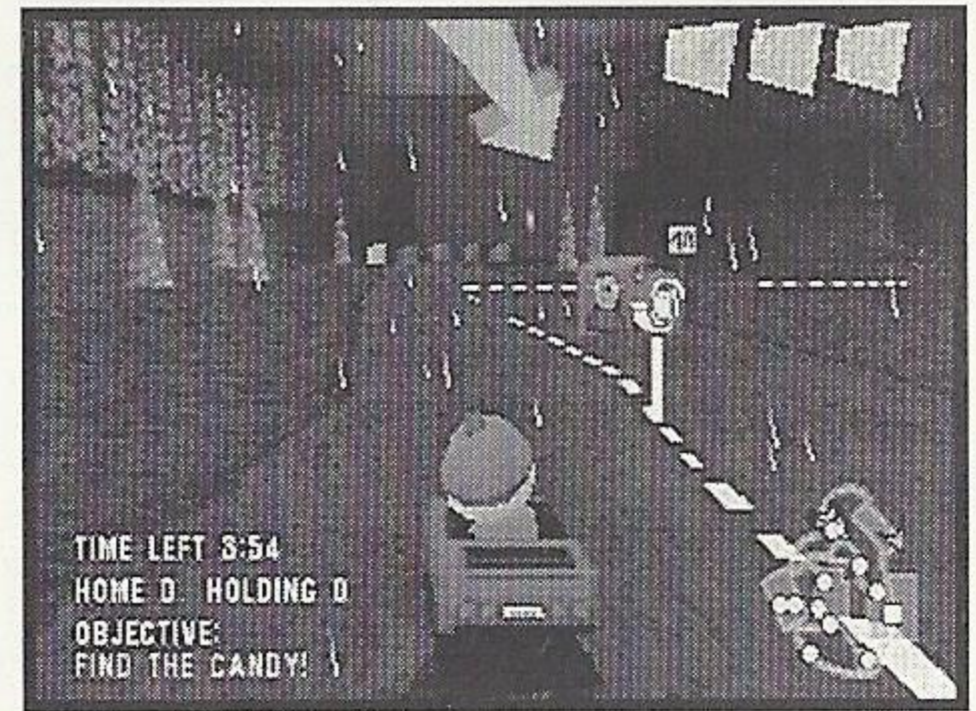

THANKSGIVING

Yum, yum! Eat 'em up! Collect 20 Thanksgiving turkeys for the poor and ring the bell to attract your well-deserved media attention to win this race. Since this is a charity race, turkeys can't be stolen from other racers.

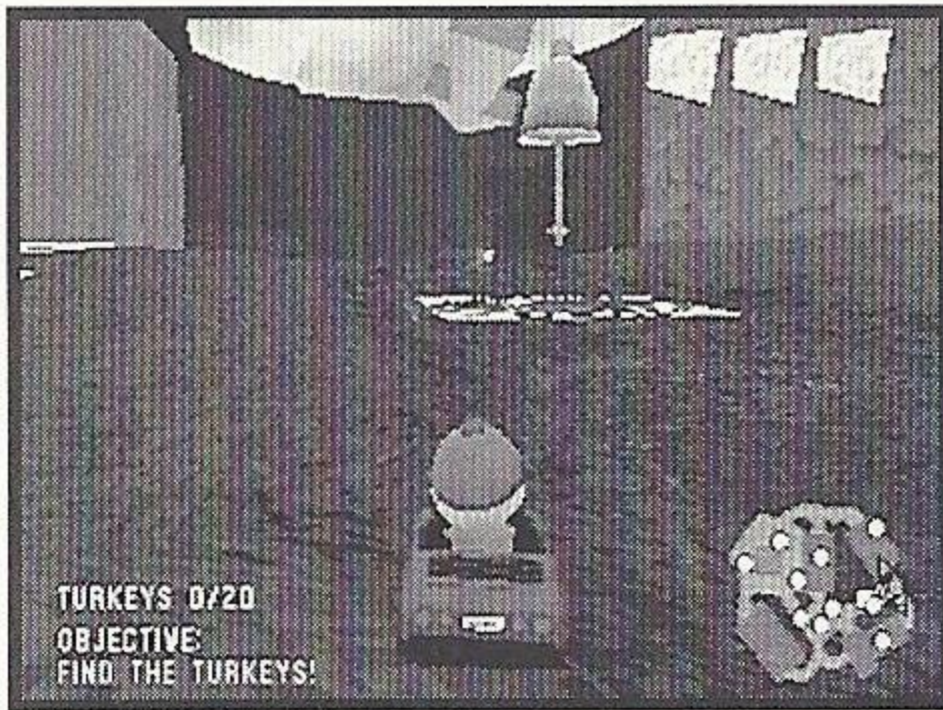

CHRISTMAS DAY

Find and collect the present. Race to the checkpoint flashing on the screen. The first player to cross checkpoint four with the present after all checkpoints have been crossed in order is the winner.

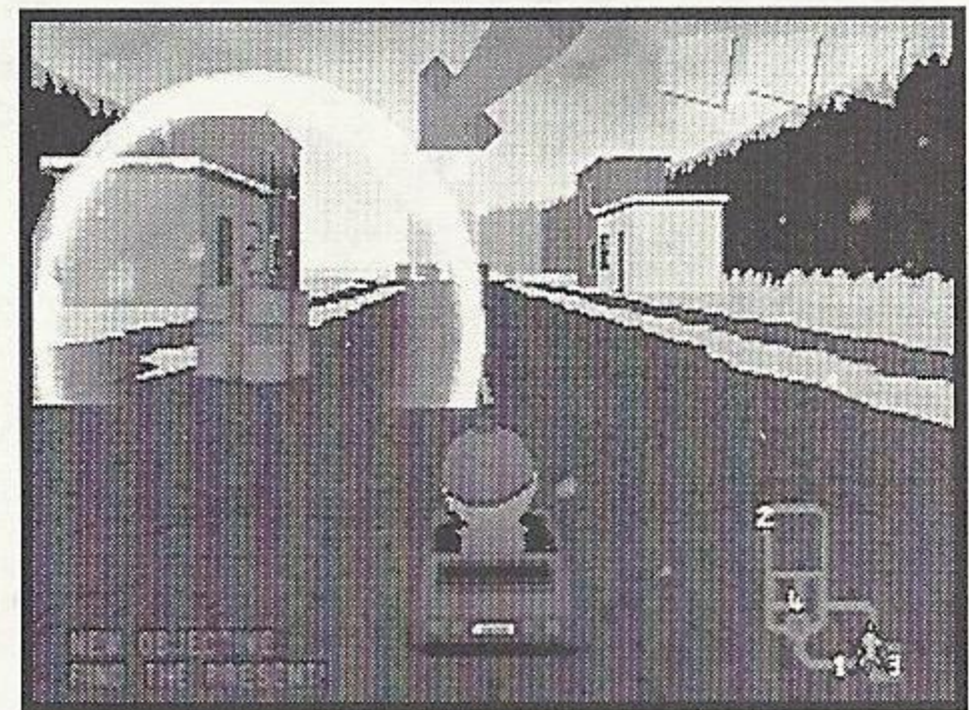

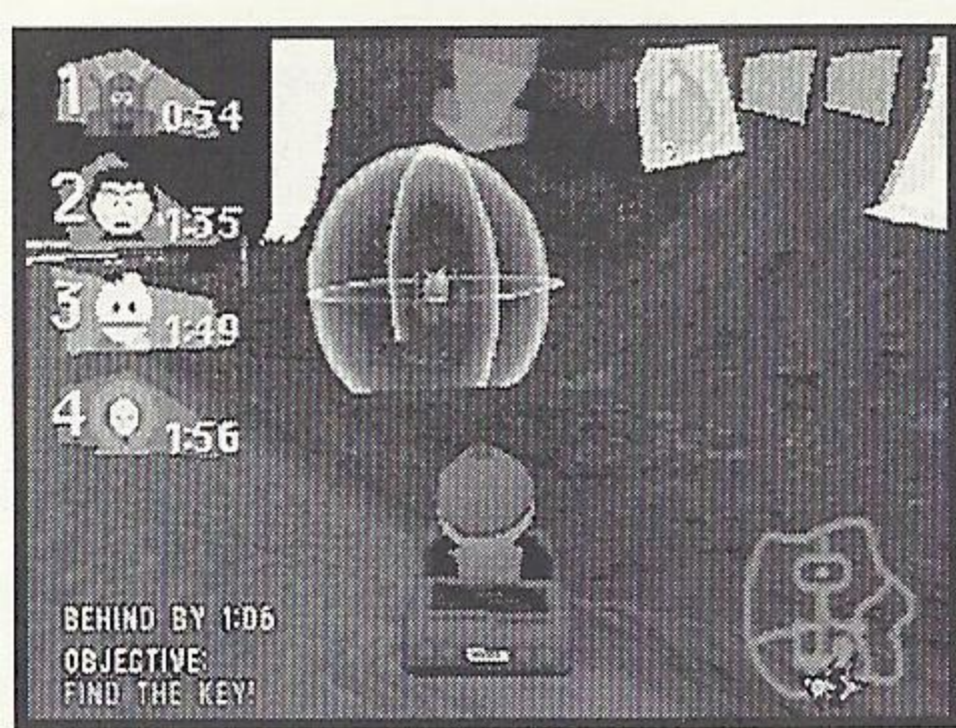

MILLENNIUM NEW YEAR'S EVE

As foretold by Nostradamus and **THE SOUTH PARK** Enquirer, Satan is going to destroy the world on the Millennium New Year's Eve. To achieve this goal, Satan must charge his Dimensional Key for 2 minutes. Grab that key and hold onto it for 2 minutes to win!

MINI CHAMPIONSHIP

Mini Championship is where you let your hair down and ride! Choose any unlocked character and race to the finish. Remember, this is a straight up racing mode where the only objective is to be first! All of the Rally tracks that you've unlocked in Championship are available to tear your friends a new asphalt!

ARCADE RACE

Practice your skills as you race with any character, on any track and any objective that you've unlocked in Championship! Hey, we'll give you a break and unlock one track and race more than you've finished in Championship just so you can practice before the big game.

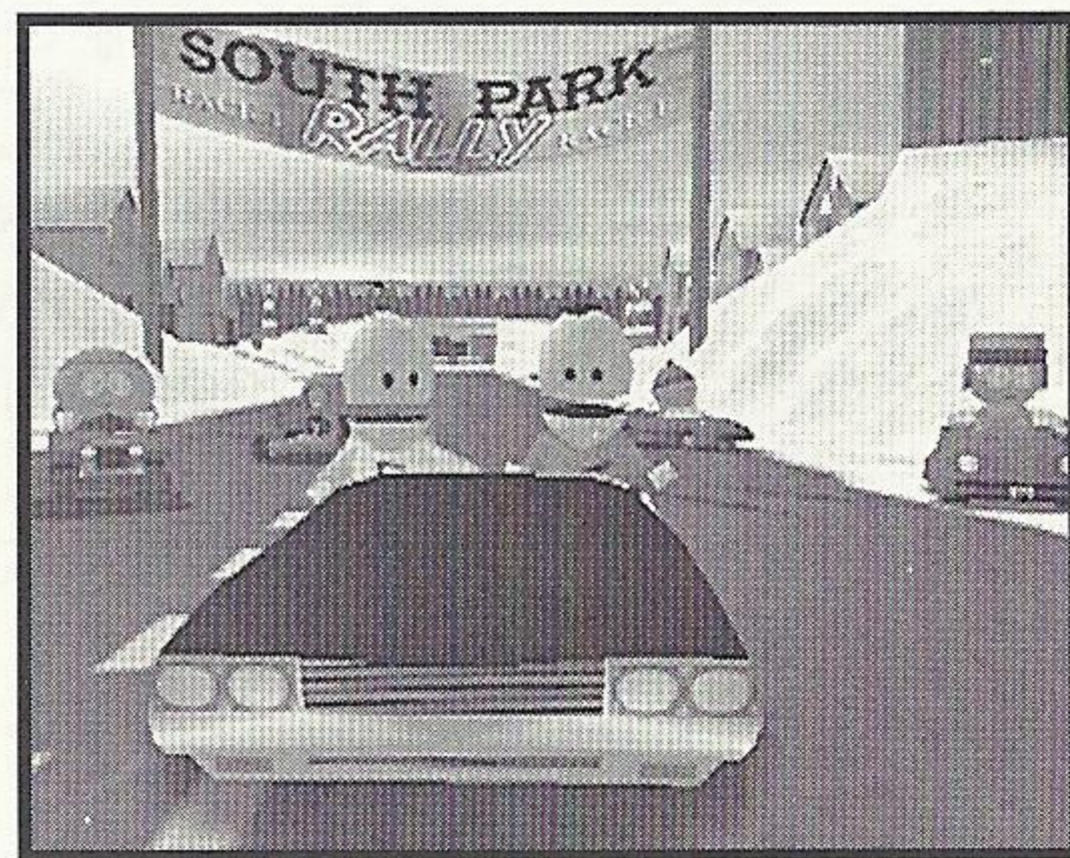

MULTIPLAYER

Race your friends in this fast paced multiplayer mode (as well as all scenarios you've unlocked in Championship)!

ASS BATTLE

Each player starts with four asses floating around their cart. Use Action Items to shoot the ass off of your opponents. Be the last man standing with at least one ass and you're the winner!

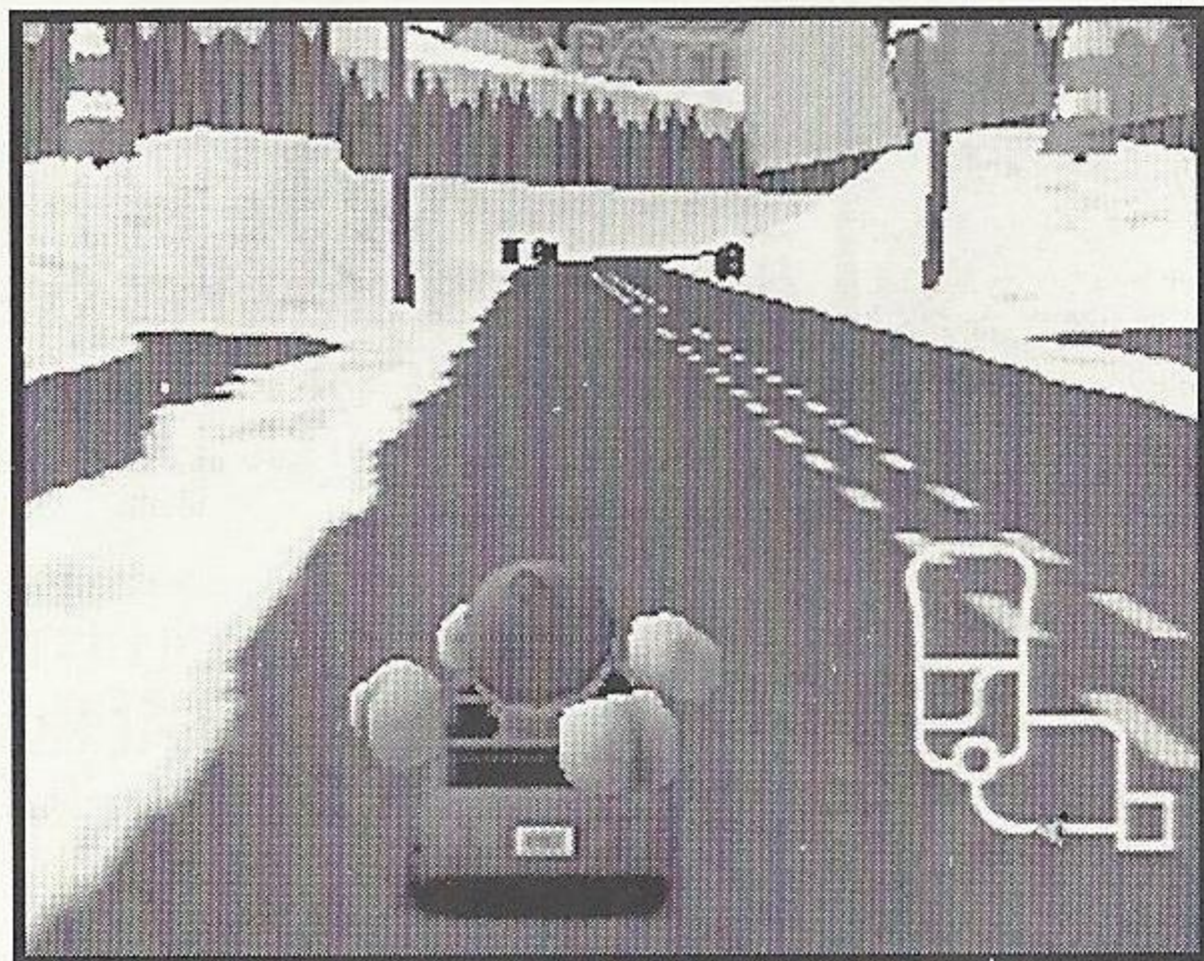

ACTION ITEMS

You'll need some help to knock those obviously lacking in the appropriate holiday spirit out of the race. These Action Items may just do the trick!

The Action Items in **SOUTH PARK RALLY** are broken up into different groups. You can tell them apart by their box color. When you pick up a box of a certain color, you get a random gadget.

All Action Items are activated by pressing the **LEFT TRIGGER** except for the Terrance Turbo, Weight Gain 4000, Mr. Hankey, Pink-eye, Spooky-Vision and Caffeine which are activated instantly when collected.



YELLOW BOX ITEMS

MR. MACKY BALLOON HEAD GADGET

This item fires a psychedelic peace sign at the player. If it hits, the player's head expands and they float up above the earth!

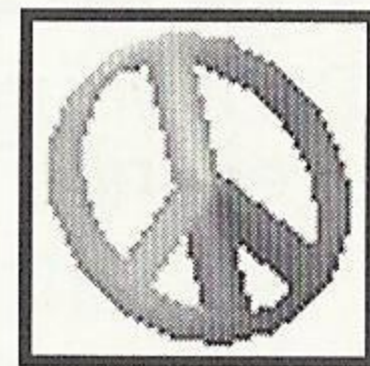

BARF

Create a puddle of fun as you watch your opponents slow down to a crawl as they attempt to drive through your splat of sticky goo!

MR. HANKEY

Mr. Hankey will protect you from danger, whether from bad Action Items or items fired at you.

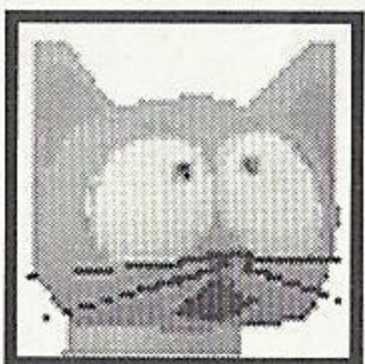

KITTY

Unleash the whirlwind of destruction that is Kitty! When you fire Kitty at your fellow racers, Kitty will home-in and blow them out of the way!

PURPLE BOX ITEMS

ANAL PROBE

The alien anal probe comes out of your driver's rear and fires a tracking laser that makes your opponents sing-a!

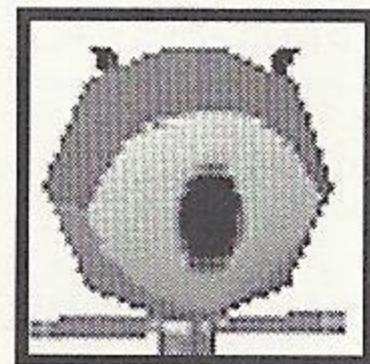

EXPLOSIVE DIARRHEA

Explosive diarrhea has the smallest range of all the mines, but the most punch!

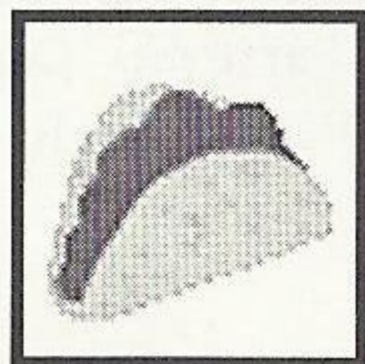

18





WEIGHT GAIN 4000

This pickup drastically increases your mass, allowing you to ram through opponents with impunity. Beefcake!

RED BOX ITEMS

CHOCOLATE SALTY BALLS

Are your opponents starting to look like they could use a pick-me-up? Well, let them suck on some Chocolate Salty Balls while you whiz to victory!

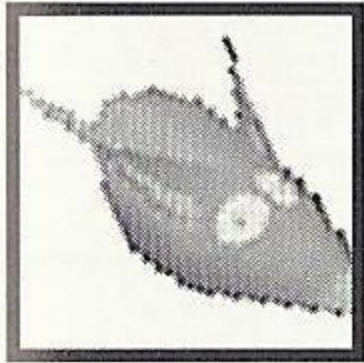
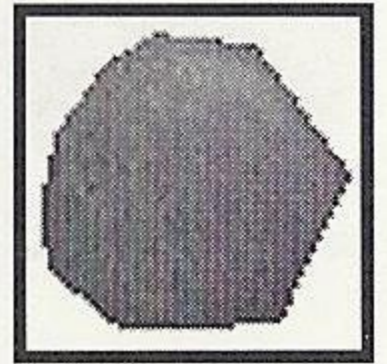

RATS

Hitting rats makes the road extremely slippery with a wet, sloppy trail of blood. Dangerous, yes. Funny...yes!

TERRANCE TURBO

Fires immediately on pickup. Just like eating beans!

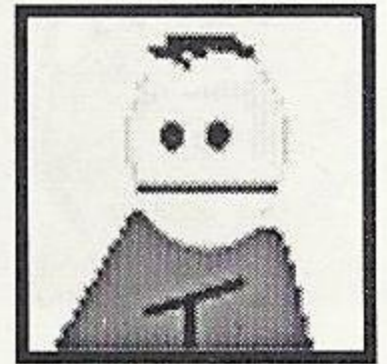

HERPES

This lovely pick-up will win your opponents a date with Frida the hooker (whether they want it or not!). Unfortunately for them, she'll leave them with a fond remembrance of their time together - herpes! Just like in life, herpes is with you to the end and multiple trips with Frida will open multiple red dots.



GREEN BOX ITEMS

CHEESY POOFS

Cheesy Poofs are a bouncing, scattering set of projectiles that explode into a cloud of cheese dust when they strike!

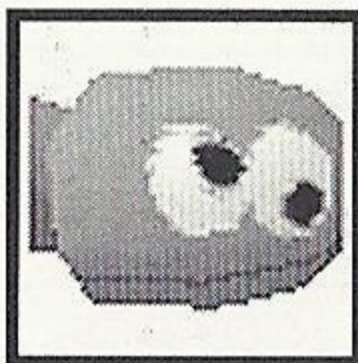
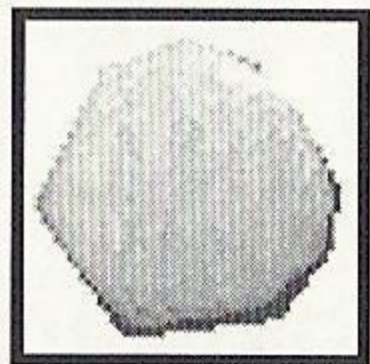

MEXICAN STARING FROG

When deployed, this mine turns all in its vicinity to stone. Player momentum is locked and they lose control. Use it when someone is hot on your tail!

PHILLIP PHART

You control this gas-powered turbo. Save it for when you need that extra burst to bring up the rear!



UNDERWEAR GNOMES

Underwear Gnomes march out, track their target and collect pickups and action items from opposing players then disappear like magic!

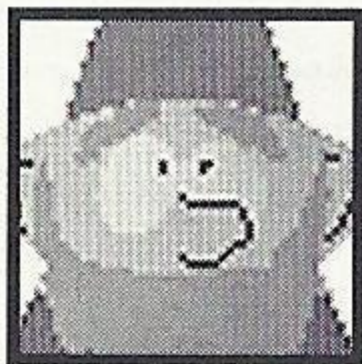

BLUE BOX ITEMS

WATER BALLOON

The water balloon is a mortar-style projectile that strikes your opponents with a big splash. Hold down the **FIRE BUTTON** for a longer shot.

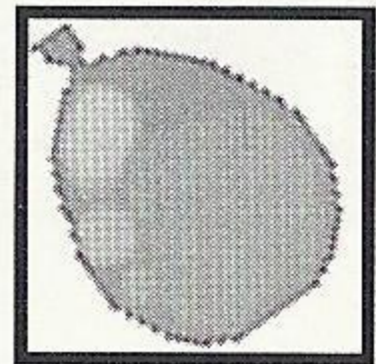



DECOY COW

The decoy cow is a fake cow that, when dropped, looks like all the other cows. Should a racer bump into the decoy cow, it will rupture, sending the car flying!

CAFFEINE

Automatically zooms your car to blazing speeds in a double cappuccino blitz!

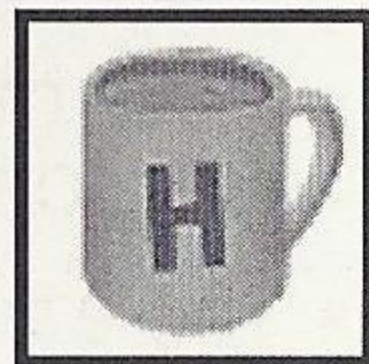

SPARKY THE DOG

When released, Sparky will chase the nearest car, grab on and stop the car cold with animal passion.

ASSORTED ITEMS

SPOOKY-VISION

Spooky-Vision can appear in any box at any time, so beware! Spooky-Vision will bring up a vision of a scary face to block your view and prevent you from seeing the road!

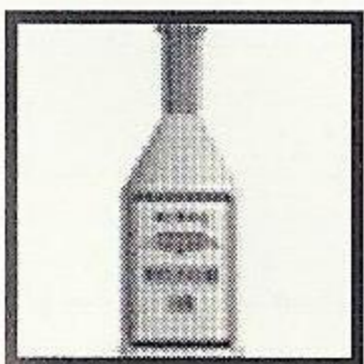
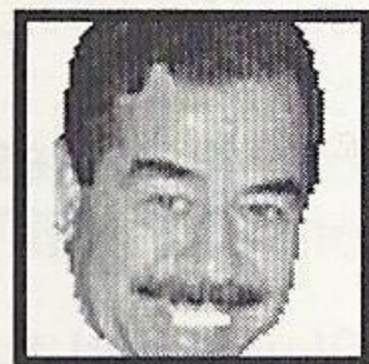

PINKEYE

Pinkeye is the rarest and most powerful of the pick-ups. It turns around all players (except the one who picks it up), reverses their steering, makes their eyes pink and puffy and reduces their reaction time.



HINTS & TIPS

- You must know the track. Practice going around the map in Mini Championship to find the best route, note where the checkpoints are and practice the jumps.
- Place mine pick-ups strategically (i.e., drop the Decoy Cow in with the real cows) to really throw your opponents for a loop!
- There's an Extra Credit Coin on every level of Championship. If you're really low in the rankings, stop trying to win and find the coin...and do better next time!
- Make sure you keep an eye on the map. read "Pucks (e.g., the chickens in Read-A-Book Day or the candy in Halloween) tend to spontaneously appear. Try to go for the pucks that don't have any CPU opponents near them as they're quite good at snapping up the prize!

**For the hottest hints and codes
on ACCLAIM Titles:**

Please call 1-900-407-Tips(8477)

The cost of the call is \$.95 per minute.

You must be 18 or have parental permission and have a touch-tone phone.



NOTES

ACCLAIM® LIMITED WARRANTY

ACCLAIM warrants to the original purchaser only of this ACCLAIM software product that the medium on which this software program is recorded is free from defects in materials and workmanship for a period of ninety (90) days from the date of purchase. This ACCLAIM software program is sold "as is," without express or implied warranty of any kind, and ACCLAIM is not liable for any losses or damages of any kind resulting from use of this program. ACCLAIM agrees for a period of ninety (90) days to either repair or replace, at its option, free of charge, any ACCLAIM software product, postage paid, with proof of date of purchase, at its Factory Service Center. Replacement of the software product, free of charge to the original purchaser (except for the cost of returning the software product) is the full extent of our liability.

This warranty is not applicable to normal wear and tear. This warranty shall not be applicable and shall be void if the defect in the ACCLAIM software product has arisen through abuse, unreasonable use, mistreatment or neglect. THIS WARRANTY IS IN LIEU OF ALL OTHER WARRANTIES AND NO OTHER REPRESENTATIONS OR CLAIMS OF ANY NATURE SHALL BE BINDING ON OR OBLIGATE ACCLAIM. ANY IMPLIED WARRANTIES APPLICABLE TO THIS SOFTWARE PRODUCT, INCLUDING WARRANTIES OF MERCHANTABILITY AND FITNESS FOR A PARTICULAR PURPOSE, ARE LIMITED TO THE NINETY (90) DAY PERIOD DESCRIBED ABOVE. IN NO EVENT WILL ACCLAIM BE LIABLE FOR ANY SPECIAL, INCIDENTAL, OR CONSEQUENTIAL DAMAGES RESULTING FROM POSSESSION, USE OR MALFUNCTION OF THIS ACCLAIM SOFTWARE PRODUCT.

Some states do not allow limitations as to how long an implied warranty lasts and/or exclusions or limitations of incidental or consequential damages so the above limitations and/or exclusions of liability may not apply to you. This warranty gives you specific rights, and you may also have other rights which vary from state to state.

This warranty shall not be applicable to the extent that any provision of this warranty is prohibited by any federal, state or municipal law which cannot be pre-empted.

Repairs/Service after Expiration of Warranty—If your software product requires repair after expiration of the 90-day Limited Warranty Period, you may contact the Consumer Service Department at the number listed below. You will be advised of the estimated cost of repair and the shipping instructions.

Acclaim Hotline/Consumer Service Department (516) 759-7800

South Park TM & © 2000 Comedy Central. All Rights Reserved. Acclaim® & © 2000 Acclaim Entertainment, Inc. All Rights Reserved. South Park Rally Developed by Tantalus Interactive. All Rights Reserved. Chef's Luv Shack Developed by Acclaim Studios Austin. All Rights Reserved. Marketed by Acclaim. Distributed by Acclaim Distribution, Inc., One Acclaim Plaza, Glen Cove, NY 11542-2777.

ESRB RATING

www.acclaim.com

This product has been rated by the Entertainment Software Rating Board. For information about the ESRB rating, or to comment about the appropriateness of the rating, please contact the ESRB at 1-800-771-3772.

Sega is registered in the US Patent and Trademark Office. Sega Dreamcast and the Dreamcast Swirl, are trademarks of SEGA. Sega of America, P.O. Box 7639, San Francisco, CA 94120. All Rights Reserved. Programmed in Japan. Made and printed in the USA. WARNING: Operates only with NTSC televisions and Sega Dreamcast systems purchased in North and South America (except Argentina, Paraguay and Uruguay). Will not operate with any other televisions or Sega Dreamcast systems. Product covered under one or more of the following U.S. Patents: 5,460,374; 5,525,770; 5,627,895; 5,688,173; 4,442,486; 4,454,594; 4,462,076; Re. 35,839; Japanese Patent No.2870538, (Patents pending in U.S. and other countries); Canada Patent No. 1,183,276. The ratings icon is a trademark of the Interactive Digital Software Association.

SEGA®

LOOK FOR

SOUTH PARK™ CHEF'S LUV SHACK™



www.acclaim.com

www.comedycentral.com

Sega is registered in the US Patent and Trademark Office. Sega Dreamcast, the Dreamcast Swirl, are trademarks of SEGA, Sega of America, P.O. Box 7639, San Francisco, CA 94120. All Rights Reserved. Programmed in Japan. Made and printed in the USA. WARNING: Operates only with NTSC televisions and Sega Dreamcast systems purchased in North and South America (except Argentina, Paraguay and Uruguay). Will not operate with any other televisions or Sega Dreamcast systems. Product covered under one or more of the following U.S. Patents: 5,460,374; 5,525,770; 5,627,895; 5,688,173; 4,442,486; 4,454,594; 4,462,076; Re. 35,839; Japanese Patent No.2870538, (Patents pending in U.S. and other countries); Canada Patent No. 1,183,276. The ratings icon is a trademark of the Interactive Digital Software Association.

Acclaim

SEGA