

1ST PRINTING MAY 01

SEGA



Deluxe Version

OWNER'S MANUAL



SEGA ENTERPRISES, INC. USA

MANUAL NO. 999-1275

VISIT OUR WEBSITE!

Address: <http://www.seuservice.com/>

Apple Central.Sega.com Sega.com SegaService.com Yahoo! Yahoo! Maps and Driving Directions

SEGA SERVICE
what's new •
manuals •
bulletins •
assemblies •
Search •

bulletin Sign-up •
register name •

staff •
Darl's Office •
tech. service •
warranty policy •

corporate info •
home page •
future technologies •
plugins •
non-framed page •

Sega Enterprises Inc.,
USA
Service Department
phone 415.701.6580
fax 415.701.6594

Ask Dave!

SEGA SERVICE
• Bulletins
• Darl's Office
• Game Manuals
• Search
• What's New

5564 people have visited this page since 3/16/01

If you have any questions or comments
about this site please E-Mail to Darl.Davidson@seu.sega.com

THIS WEB SITE POWERED BY
WebSTAR 4.3 Mac OS

[\[what's new\]](#)[\[manuals\]](#)[\[bulletins\]](#)[\[assemblies\]](#)[\[Search\]](#)[\[staff\]](#)[\[Darl's office\]](#)
[\[technical service\]](#)[\[customer service\]](#)[\[corporate info\]](#)[\[plugins\]](#)[\[Non-framed page\]](#)

You will need the following items to view this page in its entirety.

All Platforms Windows Macintosh

Internet zone

BEFORE USING THE PRODUCT, BE SURE TO READ THE FOLLOWING:

To maintain the safety:

To ensure the safe usage of the product, be sure to read the following before using the product. The following instructions are intended for the users, operators and the personnel in charge of the operation of the product. After carefully reading and sufficiently understanding the warning displays and cautions, handle the product appropriately. Be sure to keep this manual nearby the product or elsewhere convenient for referring to it when necessary.

Herein, explanations which require special attention are enclosed with dual lines. Depending on the potentially hazardous degrees, the terms of WARNING, CAUTION, etc. are used. Be sure to understand the contents of the displays before reading the text.



WARNING!

Indicates that mishandling the product by disregarding this warning will cause a potentially hazardous situation which can result in death or serious injury.



CAUTION!

Indicates that mishandling the product by disregarding this caution will cause a slight hazardous situation which can result in personal injury and or material damage.

For the safe usage of the product, the following pictographs are used:



Indicates “HANDLE WITH CARE.” In order to protect the human body and equipment, this display is attached to places where the Owner’s Manual and or Service Manual should be referred to.

○ Perform work in accordance with the instructions herein stated.

Instructions for work are explained by paying attention to the aspect of accident prevention. Failing to perform work as per the instructions can cause accidents. In the case where only those who have technical expertise should perform the work to avoid hazardous situation, the instructions herein state that the serviceman should perform such work.

○ Be sure to turn off power before working on the machine.

To prevent electric shock, be sure to turn off power before starting the work in which the worker touches the interior of the product. If the work is to be performed in the power-on status, the Instruction Manual herein always states to that effect.

○ Be sure to ground the Earth Terminal (this, however, is not required in the case where a power cord with earth is used).

This product is equipped with the Earth Terminal. When installing the product, Connect the Earth Terminal to the “accurately grounded indoor earth terminal” by using an earth wire. Unless the product is grounded appropriately, the user can be subject to electric shock. After performing repair, etc. for the Control equipment, ensure that the Earth Wire is firmly connected to the Control equipment.

○ Ensure that the Power Supply used is equipped with an Earth Leakage Breaker.

This product does not incorporate the Earth Leakage Breaker. Using a power supply which is not equipped with the Earth Leakage Breaker can cause a fire when earth leakage occurs.

○ Be sure to use fuses which meet the specified rating. (only for the machines which use fuses).

Using fuses exceeding the specified rating can cause a fire and electric shock.

○ **Specification changes (removal of equipment, conversion and addition) not designated by SEGA are not allowed.**

The parts of the product include warning labels for safety, covers for personal protection, etc. It is very hazardous to operate the product by removing parts and or modifying the circuits. Should doors, lids and protective parts be damaged or lost, refrain from operating the product, and contact where the product was purchased from or the office herein stated. SEGA shall not be held responsible for any accidents, compensation for damage to a third party, resulting from the specifications not designated by SEGA.

○ **Ensure that the product meets the requirements of appropriate Electrical Specifications.**

Before installing the product, check for Electrical Specifications. SEGA products have a nameplate on which Electrical Specifications are described. Ensure that the product is compatible with the power supply voltage and frequency requirements of the location. Using any Electrical Specifications different from the designated Specifications can cause a fire and electric shock.

○ **Install and operate the product in places where appropriate lighting is available, allowing warning labels to be clearly read.**

To ensure safety for the customers, labels and printed instructions describing potentially hazardous situation are applied to places where accidents can be caused. Ensure that where the product is operated has sufficient lighting allowing the warnings to be read. If any label is peeled off, apply it again immediately. Please place an order with where the product was purchased from or the office herein stated.

○ **When handling the Monitor, be very careful. (Applies only to the product w/monitor.)**

Some of the monitor (TV) parts are subject to high tension voltage. Even after running off power, some portions are still subject to high tension voltage sometimes. Monitor repair and replacement should be performed only by those technical personnel who have knowledge of electricity and technical expertise.

○ **Be sure to adjust the monitor (projector) properly. (Applies only to the product w/monitor.)**

Do not operate the product leaving on-screen flickering or blurring as it is. Using the product with the monitor not properly adjusted may cause dizziness or a headache to an operator, a player, or the customers.

○ **When transporting or reselling this product, be sure to attach this manual to the product.**

In the case where commercially available monitors and printers are used in this product, only the contents relating to this product are explained herein. Some commercially available equipment has functions and reactions not stated in this manual. Read this manual together with the specific Instruction Manual of such equipment.

- Descriptions herein contained may be subject to improvement changes without notice.
- The contents described herein are fully prepared with due care. However, should any question arise or errors be found, please contact SEGA.

INSPECTIONS IMMEDIATELY AFTER TRANSPORTING THE PRODUCT TO THE LOCATION.

Normally, at the time of shipment, SEGA products are in a status allowing for usage immediately after transporting to the location. Nevertheless, an irregular situation may occur during transportation. Before turning on power, check the following points to ensure that the product has been transported in a satisfactory status.

- Are there any dented portions or defects (cuts, etc.) on the external surfaces of the cabinet?
- Are Casters and Adjusters, damaged?
- Do the power supply voltage and frequency requirements meet with those of the location?
- Are all wiring connectors correctly and securely connected? Unless connected in the correct direction, connector connections can not be made accurately. Do not insert connectors forcibly.
- Do power cords have cuts and dents?
- Do the fuses used meet specified rating? Is the Circuit Protector in an energized status?
- Are all accessories available?
- Can all Doors and Lids be opened with the Accessory keys? Can Doors and Lids be firmly closed?

TABLE OF CONTENTS

BEFORE USING THE PRODUCT, BE SURE TO READ THE FOLLOWING:

TABLE OF CONTENTS

INTRODUCTION OF THE OWNER'S MANUAL

1. HANDLING PRECAUTIONS	1
2. PRECAUTIONS CONCERNING INSTALLATION LOCATION	2 - 3
3. OPERATION	4 - 5
4. NAME OF PARTS	6
5. ACCESSORIES	7 - 9
6. ASSEMBLING AND INSTALLATION	10 - 23
7. PRECAUTIONS TO BE HEDED WHEN MOVING THE MACHINE	24 - 26
8. CONTENTS OF GAME	27 - 33
9. EXPLANATION OF TEST AND DATA DISPLAY	34 - 72
9 - 1 SWITCH UNIT AND COIN METER	36 - 37
9 - 2 SYSTEM TEST MODE	38 - 50
9 - 3 GAME TEST MODE	51 - 72
10. CONTROL PANEL	73 - 76
10 - 1 ADJUSTING/REPLACING THE V.R.	73 - 76
10 - 2 GREASING	76
11. ACCELERATOR & BRAKE	77 - 78
11 - 1 ADJUSTING AND REPLACING THE V.R.	77 - 78
11 - 2 GREASING	78
12. PROJECTOR	79 - 92
12 - 1 CLEANING THE SCREEN	79
12 - 2 ADJUSTMENT OF TOSHIBA PROJECTOR	80 - 89
12 - 3 ADJUSTMENT OF MITSUBISHI PROJECTOR	90 - 92
13. COIN SELECTOR	93 - 97
14. REPLACING THE FLOURESCENT LAMP, AND LAMPS	98 - 99
15. PERIODIC INSPECTION TABLE	100 - 101
16. TROUBLESHOOTING	102 - 104
17. GAME BOARD	105 - 107
17 - 1 REMOVING THE GAME BOARD	106 - 107
18. COMMUNICATION PLAY	108 - 115
18 - 1 INSTALLATION PRECAUTIONS	108 - 109
18 - 2 CONNECTING THE COMMUNICATION CABLE	109 - 113
18 - 3 SETTING FOR COMMUNICATION PLAY	114 - 115
18 - 4 CAUTIONS TO BE HEDED DURING COMMUNICATION PLAY	115
19. DESIGN RELATED PARTS	116 - 117
20. PARTS LIST	118 - 148
21. WIRE COLOR CODE TABLE	149
22. WIRING DIAGRAM	150 - 153

SPECIFICATIONS

Installation Space	: 1,360 mm (W) X 2,610 mm (D) (53.5 in. X 102.8 in.)
Height	: 2,230 mm (87.8 in.)
Weight	: 450 kg. (992.1 lbs.)
Power, maximum current	: 625 W 6.70 A (AC 120V 60 Hz AREA) 675 W 4.00 A (AC 220V 50 Hz AREA) 640 W 3.80 A (AC 220V 60 Hz AREA) 675 W 3.60 A (AC 240V 50 Hz AREA)
For TAIWAN	
Power, current	: 750 W 9.20 A (MAX.) 350 W 3.80 A (MIN.)
MONITOR	: 50 TYPE PROJECTION DISPLAY

INTRODUCTION OF THE OWNERS MANUAL

This Owner's Manual is intended to provide detailed descriptions together with all the necessary information covering the general operation of electronic assemblies, electromechanicals, servicing control, spare parts, etc. as regards the product, **CLUB KART DX TYPE.**

This manual is intended for the owners, personnel and managers in charge of operation of the product. Operate the product after carefully reading and sufficiently understanding the instructions. If the product fails to function satisfactorily, non-technical personnel should under no circumstances touch the internal system. Please contact where the product was purchased from.

Use of this product is unlikely to cause physical injuries or damages to property. However, where special attention is required this is indicated by a thick line, the word "IMPORTANT" and its sign in this manual.



Indicates that mishandling the product by disregarding this display can cause the product's intrinsic performance not to be obtained, resulting in malfunctioning.

IMPORTANT

SEGA ENTERPRISES, INC. (U.S.A.)/CUSTOMER SERVICE
45133 Industrial Drive, Fremont, California 94538, U.S.A.
Phone : (415) 701-6580
Fax : (415) 701-6594

DEFINITION OF LOCATION MAINTENANCE MAN AND SERVICEMAN



Non-technical personnel who do not have technical knowledge and expertise should refrain from performing such work that this manual requires the location's maintenance man or a serviceman to carry out, or work which is not explained in this manual. Failing to comply with this instruction can cause a severe accident such as electric shock.

Ensure that parts replacement, servicing & inspections, and troubleshooting are performed by the location's maintenance man or the serviceman. It is instructed herein that particularly hazardous work should be performed by the serviceman who has technical expertise and knowledge.

The location's maintenance man and serviceman are herein defined as follows:

"Location's Maintenance Man" :

Those who have experience in the maintenance of amusement equipment and vending machines, etc., and also participate in the servicing and control of the equipment through such routine work as equipment assembly and installation, servicing and inspections, replacement of units and consumables, etc. within the Amusement Facilities and or locations under the management of the Owner and Owner's Operators of the product.

Activities of Location's Maintenance Man :

Assembly & installation, servicing & inspections, and replacement of units & consumables as regards amusement equipment, vending machines, etc.

Serviceman :

Those who participate in the designing, manufacturing, inspections and maintenance service of the equipment at an amusement equipment manufacturer.

Those who have technical expertise equivalent to that of technical high school graduates as regards electricity, electronics and or mechanical engineering, and daily take part in the servicing & control and repair of amusement equipment.

Serviceman's Activities :

Assembly & installation and repair & adjustments of electrical, electronic and mechanical parts of amusement equipment and vending machines.

LISTED



5K92

AMUSEMENT MACHINE

1. HANDLING PRECAUTIONS

When installing or inspecting the machine, be very careful of the following points and pay attention to ensure that the player can enjoy the game safely.

Non-compliance with the following points or inappropriate handling running counter to the cautionary matters herein stated can cause personal injury or damage to the machine.



WARNING!

- Before performing work, be sure to turn power off. Performing the work without turning power off can cause an electric shock or short circuit. In the case work should be performed in the status of power on, this manual always states to that effect.
- To avoid electric shock or short circuit, do not plug in or unplug quickly.
- To avoid electric shock, do not plug in or unplug with a wet hand.
- Do not expose Power Cords and Earth Wires on the surface, (floor, passage, etc.). If exposed, the Power Cords and Earth Wires are susceptible to damage. Damaged cords and wires can cause electric shock or short circuit.
- To avoid causing a fire or electric shock, do not put things on or damage Power Cords.
- When or after installing the product, do not unnecessarily pull the power cord. If damaged, the power cord can cause a fire or electric shock.
- In case the power cord is damaged, ask for replacement through where the product was purchased from or the office herein stated. Using the cord as is damaged can cause fire, electric shock or leakage.
- Be sure to perform grounding appropriately. Inappropriate grounding can cause an electric shock.
- Be sure to use fuses meeting specified rating. Using fuses exceeding the specified rating can cause a fire or electric shock.
- Completely make connector connections for IC BD and others. Insufficient insertion can cause an electric shock.
- Specification changes, removal of equipment, conversion and/or addition, not designated by SEGA are not permitted.
 - Failure to observe this may cause a fire or an electric shock. Non-compliance with this instruction can have a bad influence upon physical conditions of the players or the lookers-on, or result in injury during play.
 - SEGA shall not be held responsible for damage, compensation for damage to a third party, caused by specification changes not designated by SEGA.
- Be sure to perform periodic maintenance inspections herein stated.



IMPORTANT

- For the IC board circuit inspections, only the logic tester is allowed. The use of a multiple-purpose tester is not permitted, so be careful in this regard.
- The Projector is employed for this machine. The Projector's screen is susceptible to damage, therefore, be very careful when cleaning the screen. For details, refer to PROJECTOR.

2. PRECAUTIONS CONCERNING INSTALLATION

LOCATION



WARNING!

This product is an indoor game machine. Do not install it outside. Even indoors, avoid installing in places mentioned below so as not to cause a fire, electric shock, injury and or malfunctioning.

- Places subject to rain or water leakage, or places subject to high humidity in the proximity of an indoor swimming pool and or shower, etc.
- Places subject to direct sunlight, or places subject to high temperatures in the proximity of heating units, etc.
- Places filled with inflammable gas or vicinity of highly inflammable/volatile chemicals or hazardous matter.
- Dusty places.
- Sloped surfaces.
- Places subject to any type of violent impact.
- Vicinity of anti-disaster facilities such as fire exits and fire extinguishers.
- The operating (ambient) temperature range is from 5 C° to 40 C°. Only in the case a projector is employed, the temperature range is from 5 C° to 30 C°.

LIMITATIONS OF USAGE REQUIREMENTS



WARNING!

- Be sure to check the Electrical Specifications. Ensure that this product is compatible with the location's power supply, voltage and frequency requirements. A plate describing Electrical Specifications is attached to the product. Non-compliance with the Electrical Specifications can cause a fire and electric shock.
- This product requires the Breaker and Earth Mechanisms as part of the location facilities. Using them in a manner not independent can cause a fire and electric shock.
- Ensure that the indoor wiring for the power supply is rated at 15A or higher (AC single phase 100 ~ 120V area), and 7A or higher (AC 220 ~ 240V area). Non-compliance with the Electrical Specifications can cause a fire and electric shock.
- Be sure to independently use the power supply equipped with the Earth Leakage Breaker. Using a power supply without the Earth Leakage Breaker can cause an outbreak of fire when earth leakage occurs.
- Putting many loads on one electrical outlet can cause generation of heat and a fire resulting from overload.
- When using an extension cord, ensure that the cord is rated at 15A or higher (AC 100 ~ 120V area) and 7A or higher (AC 220 ~ 240V area). Using a cord rated lower than the specified rating can cause a fire and electric shock.

OPERATION AREA



WARNING!

- For the operation of this machine, secure a minimum area of 2.0m (W) X 2.8m (D). In order to prevent injury resulting from the falling down accident during game play, be sure to secure the minimum area for operation.
- Be sure to provide sufficient space so as to allow this product's ventilation fan to function efficiently. To avoid machine malfunctioning and a fire, do not place any obstacles near the ventilation opening.
- SEGA shall not be held responsible for damage, compensation for damage to a third party, resulting from the failure to observe this instruction.



IMPORTANT

For transporting the machine into the location's building, the minimum necessary dimensions of the opening (of doors, etc.) are 1.4m(W) and 1.7m(H).

Electric current consumption

MAX. 6.7 A (AC 120V 60 Hz)
MAX. 4.0 A (AC 220V 50 Hz)
MAX. 3.8 A (AC 220V 60 Hz)
MAX. 3.6 A (AC 240V 50 Hz)
MAX. 9.2 A (For TAIWAN)

3. OPERATION

PRECAUTIONS TO BE HEEDED BEFORE STARTING THE OPERATION

To avoid injury and trouble, be sure to constantly give careful attention to the behavior and manner of the visitors and players.



WARNING!

In order to avoid accidents, check the following before starting the operation:

- To ensure maximum safety for the players and the customers, ensure that where the product is operated has sufficient lighting to allow any warnings to be read. Operation under insufficient lighting can cause bodily contact with each other, hitting accident, and or trouble between customers.
- Be sure to perform appropriate adjustment of the monitor (projector). For operation of this machine, do not leave monitor's flickering or deviation as is. Failure to observe this can have a bad influence upon the players' or the customers' physical conditions.
- It is suggested to ensure a space allowing the players who feel sick while playing the game to take a rest.
- Check if all of the adjusters are in contact with the surface. If they are not, the Cabinet can move and cause an accident.

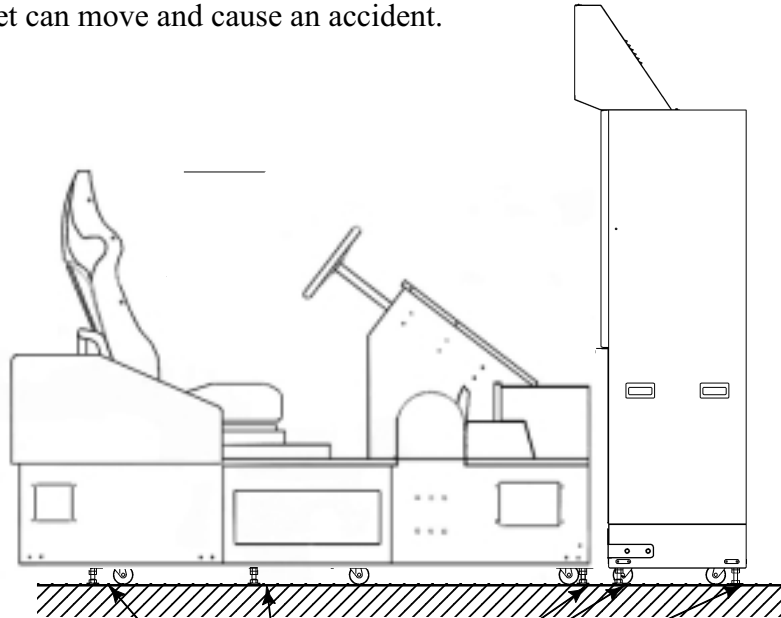

Ensure that all of the Adjusters are in contact with the floor.



WARNING!

- Do not put any heavy item on this product. Placing any heavy item on the product can cause a falling down accident or parts damage.
- Do not climb on the product. Climbing on the product can cause falling down accidents. To check the top portion of the product, use a step.
- To avoid electric shock, check to see if door & cover parts are damaged or omitted.
- To avoid electric shock, short circuit and or parts damage, do not put the following items on or in the periphery of the product.
Flower vases, flowerpots, cups, water tanks, cosmetics, and receptacles/containers/vessels containing chemicals and water.



To avoid injury, be sure to provide sufficient space by considering the potentially crowded situation at the installation location. Insufficient installation space can cause making bodily contact with each other, hitting accidents, and or trouble between customers.

PRECAUTIONS TO BE HEEDED DURING OPERATION (PAYING ATTENTION TO CUSTOMERS)

To avoid injury and trouble, be sure to constantly give careful attention to the behavior and manner of the visitors and players.



- To avoid injury and accidents, those who fall under the following categories are not allowed to play the game.
 - Those who need assistance such as the use of an apparatus when walking.
 - Those who have high blood pressure or a heart problem.
 - Those who have experienced muscle convulsion or loss of consciousness when playing video game, etc.
 - Those who have a trouble in the neck and or spinal cord.
 - Intoxicated persons.
 - Pregnant women or those who are in the likelihood of pregnancy.
 - Persons susceptible to motion sickness.
 - Persons whose act runs counter to the product's warning displays.
- A player who has never been adversely affected by light stimulus might experience dizziness or headache depending on his physical condition when playing the game. Especially, small children can be subject to those conditions. Caution guardians of small children to keep watch on their children during play.
- Instruct those who feel sick during play to have a medical examination.
- To avoid injury resulting from falling down and electric shock due to spilled drinks, instruct the player not to place heavy items or drinks on the product.
- To avoid electric shock and short circuit, do not allow customers to put hands and fingers or extraneous matter in the openings of the product or small openings in or around the doors.
- To avoid falling down and injury resulting from falling down, immediately stop the customer's leaning against or climbing on the product, etc.
- To avoid electric shock and short circuit, do not allow the customers to unplug the power plug without a justifiable reason.



- Immediately stop such violent acts as hitting and kicking the product. Such violent acts can cause parts damage or falling down, resulting in injury due to fragments and falling down.
- Instruct the Player to adjust the seat before playing the game. Playing the game in a forcible posture can cause a contingent accident.

4. NAME OF PARTS

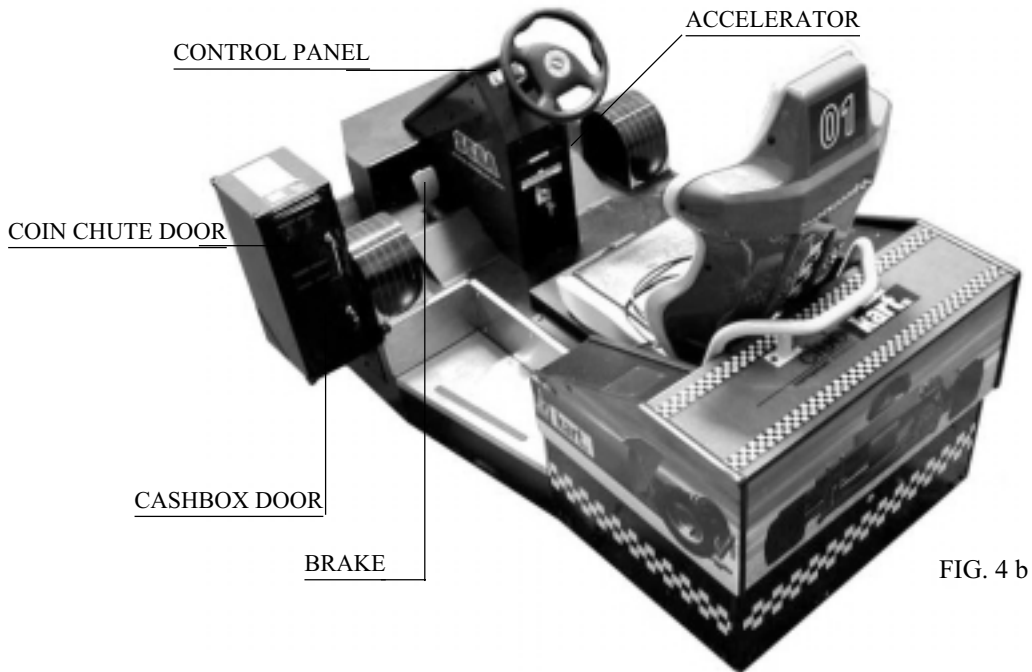
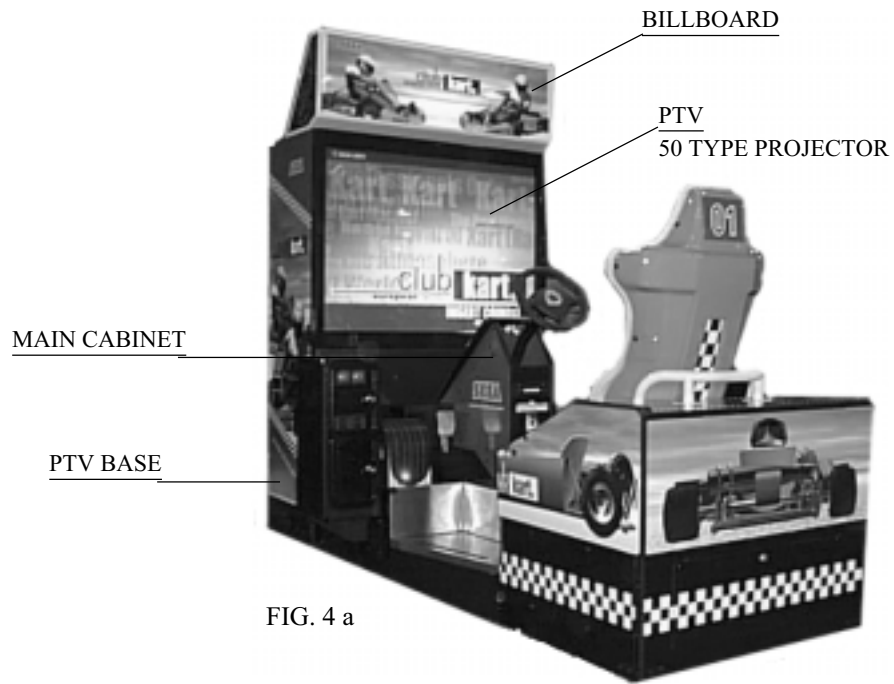

TABLE 4

	Width	X	Length	X	Height	Weight
PROJECTOR(PTV)	1,140 mm	X	555 mm	X	1,670 mm	112 kg
PTV BASE	1,160 mm	X	545 mm	X	235 mm	28 kg
BILLBOARD	1,140 mm	X	400 mm	X	410 mm	19 kg
MAIN CABINET	1,140 mm	X	2,080 mm	X	1,590 mm	300 kg
When assembled	1,310 mm	X	2,610 mm	X	2,230 mm	450 kg

5. ACCESSORIES

When transporting the machine, make sure that the following parts are supplied.

TABLE 5 ACCESSORIES

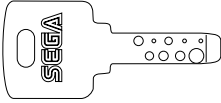
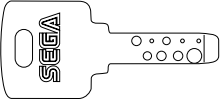
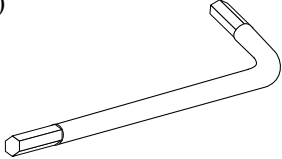
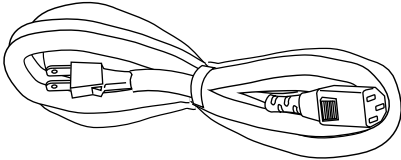
<p>DESCRIPTION Part No. (Qty.) Note</p>	<p>OWNERS MANUAL 420-6588-01 (1)</p>	<p>KEY MASTER 220-5576 (2) For opening/closing the doors</p>	<p>KEY (2) For the CASHBOX DOOR</p>
<p>Figures If Part No. has no description, the Number has not been registered or can not be registered. Such a part may not be obtainable even if the customer desires to purchase it. Therefore, ensure that the part is in safekeeping with you.</p>			
<p>TAMPERPROOF WRENCH M8 540-0009-01 (1) TOOL</p>		<p>The Keys are inside the Coin Chute Door at the time of shipment from the factory.</p>	
		<p>AC Cable (Power Cord) 600-7228 (1) TAIWAN 600-6695 (1) USA 600-6618 (1) OTHERS 600-6619 (1) HONG KONG Used for installation, see 4 of Section 6.</p>	
			

TOSHIBA
Remote Controller used for
adjustment of the projector.
See Section 14.
200-5536(1)

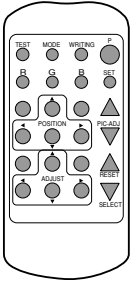

MITSUBISHI
Remote Controller used for
adjustment of the projector.
See Section 14.
200-5532(1)

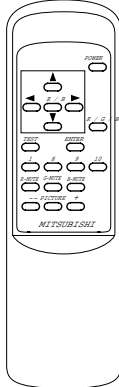

One of the above 3 types of
Remote Controllers is used for the
Projector.

The Remote Controller is attached to the Projector at the
time of shipment.

CARTON BOX
601-10642 (1)
Used for transporting the
Game Board.
Refer to Next Page.

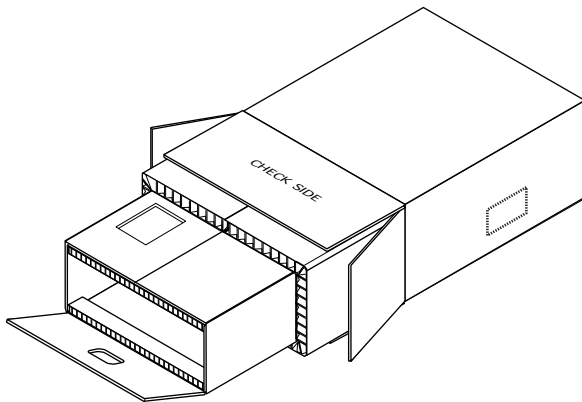

FLEX TUBE
310-5050-220200 (1)
For communication play,
refer to Section 20.

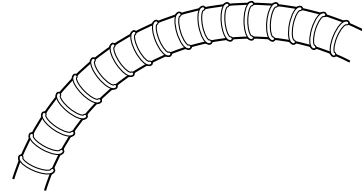

ASSY FIBER CABLE
600-6275-0500 (1)
For communication play,
refer to Section 20.

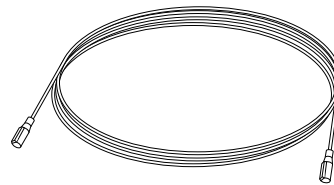

CONN 22
310-5051-22 (2)
For communication play,
refer to Section 20.

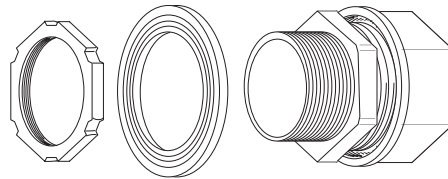

HOW TO USE THE CARTON BOX



- When asking for the replacement or repair of the product's Game Board (NAOMI 2), be sure to put the Game Board together with the Shield Case in a Carton Box. Otherwise, the request is not acceptable.
- Put the Shield Case in the Carton Box by paying attention to the correct direction as per the following instructions and as shown by the instructions printed on the Carton Box. Handling in an erroneous manner can damage the Game Board.
- Remove the Shield Case Brackets from the Shield Case and put the Shield Case in the Carton Box.

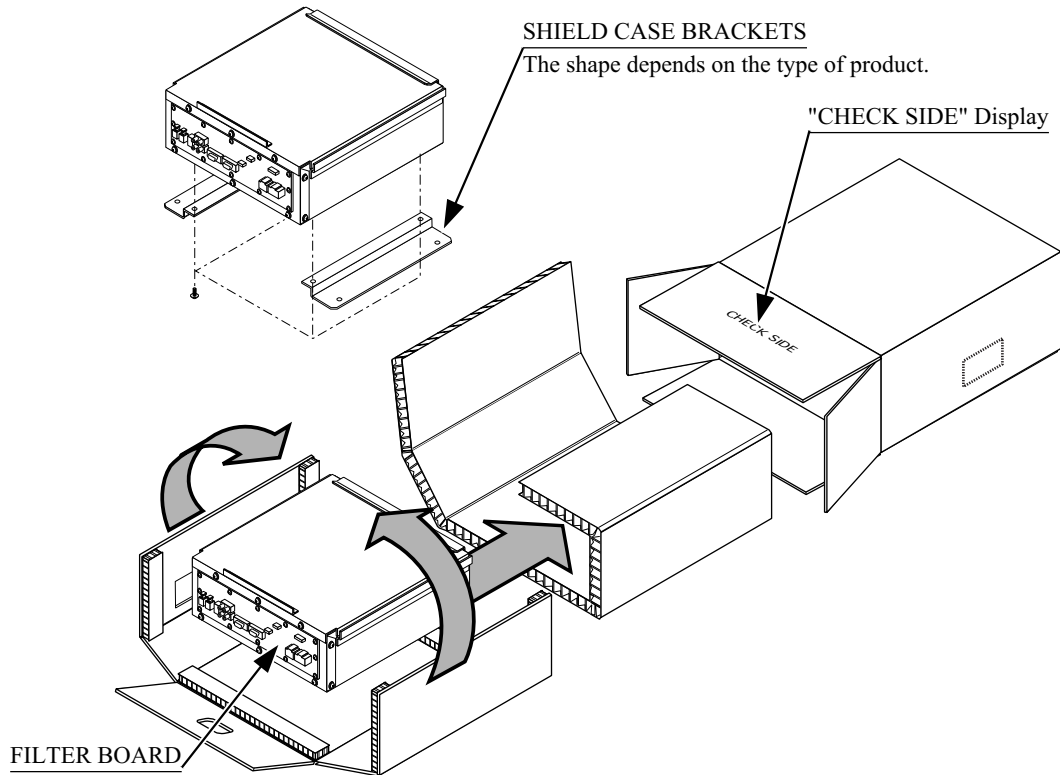

Wrap the Shield Case with the packing material and put it in the Carton Box as shown. Putting it upside down or packing otherwise in the manner not shown can damage the Game Board and parts.

6. ASSEMBLING AND INSTALLATION



WARNING!

- Perform assembly work by following the procedure herein stated. Failing to comply with the instructions can cause electric shock hazard.
- Perform assembling as per this manual. Since this is a complex machine, erroneous assembling can cause an electric shock, machine damage and or not functioning as per specified performance.
- When assembling, be sure to use plural persons. Depending on the assembly work, there are some cases in which working by one person alone can cause personal injury or parts damage.
- Ensure that connectors are accurately connected. Incomplete connections can cause electric shock hazard.
- Be careful so as not to damage wirings. Damaged wiring can cause electric shock and short circuit hazards.
- Do not carelessly push the PTV. Pushing the PTV carelessly can cause the PTV to fall down.
- This work should be performed by the Location's Maintenance Man or Serviceman. Performing work by non-technical personnel can cause a severe accident such as electric shock. Failing to comply with this instruction can cause a severe accident such as electric shock to the player during operation.
- Provide sufficient space so that assembling can be performed. Performing work in places with narrow space or low ceiling may cause an accident and assembly work to be difficult.
- To perform work safely and avoid serious accident such as the cabinet's falling down, do not perform work in places where step-like grade differences, a ditch, or slope exist.
- Carefully handle the PTV on the PTV base because it is very unstable. If handled carelessly, it may fall down and eventually cause a serious personal injury.



CAUTION!

To perform work safely and securely, be sure to prepare a step which is in a secure and stable condition. Performing work without using the step can cause violent falling down accidents.

When carrying out the assembling and installation, follow the following 6-item sequence.

- 1** ASSEMBLING THE PTV
- 2** COUPLING THE MAIN CABINET TO THE PTV
- 3** SECURING IN PLACE (ADJUSTER ADJUSTMENT)
- 4** POWER SUPPLY CONNECTION
- 5** TURNING POWER ON
- 6** ASSEMBLING CHECK

The master key (accessories) in addition to the tools such as a Phillips type screwdriver, wrench, socket wrench and Ratchet Handle are required for the assembly work.

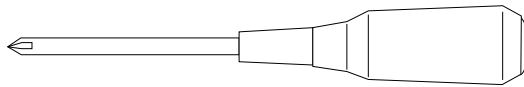

Phillips type screwdriver

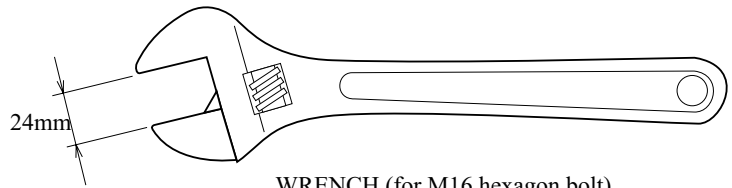

WRENCH (for M16 hexagon bolt)

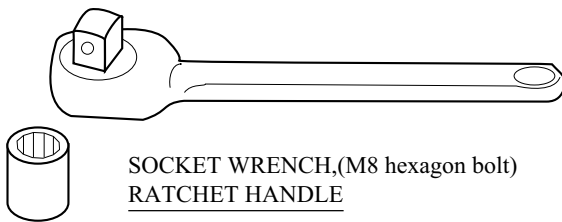

SOCKET WRENCH,(M8 hexagon bolt)
RATCHET HANDLE

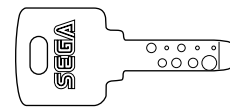

KEY MASTER

1

ASSEMBLING THE PTV

- ① Fix the two mask holders onto the PTV top panel each with the 2 countersunk-head screws.
- ② Insert and raise the TV mask as illustrated below, and fix it with the 6 screws.
- ③ Fix the panel-mounting brackets L and R onto the PTV front each with the 2 screws.
- ④ Mount the front panel onto the PTV front. Fix it with the 4 trusshead screws.

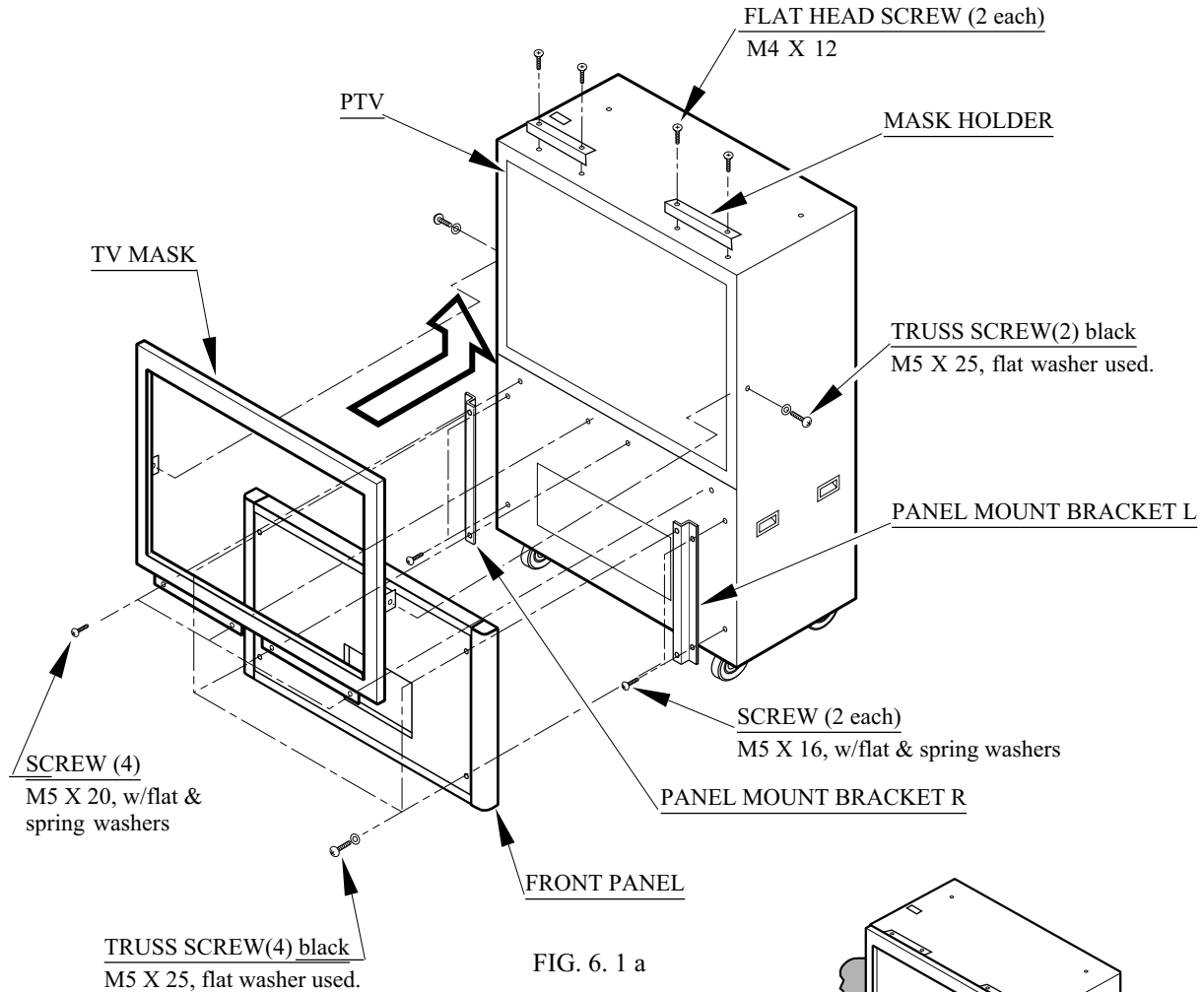

- ⑤ Place the PTV on the PTV base. Minimum 3 workers must engage in lifting the PTV while several other works must hold the PTV base.

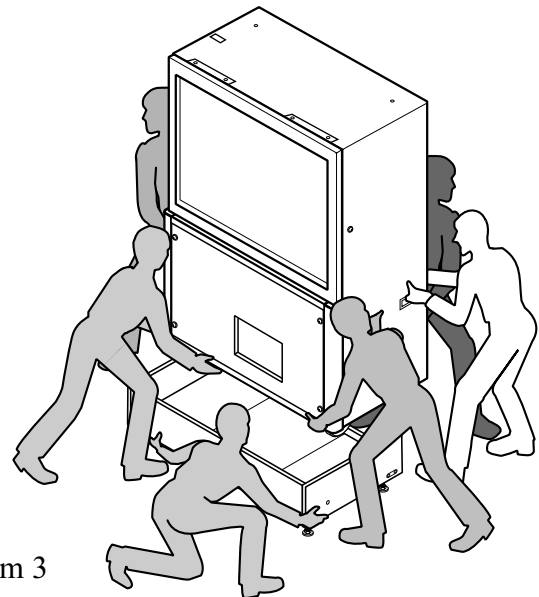

When lifting the PTV the minimum 3 workers must cooperate.

- ⑥ Connect the billboard wire's two connectors to the PTV top panel's connectors. For the safety the 2 workers must hold the billboard while another worker must use a stool when connecting.

- ⑦ Place the billboard on the PTV top panel. Engaging the billboard on the 2 mask holders, slide it to the PTV front. Be careful not to damage the wires in this instance.

- ⑧ Fix the billboard with the 2 screws.

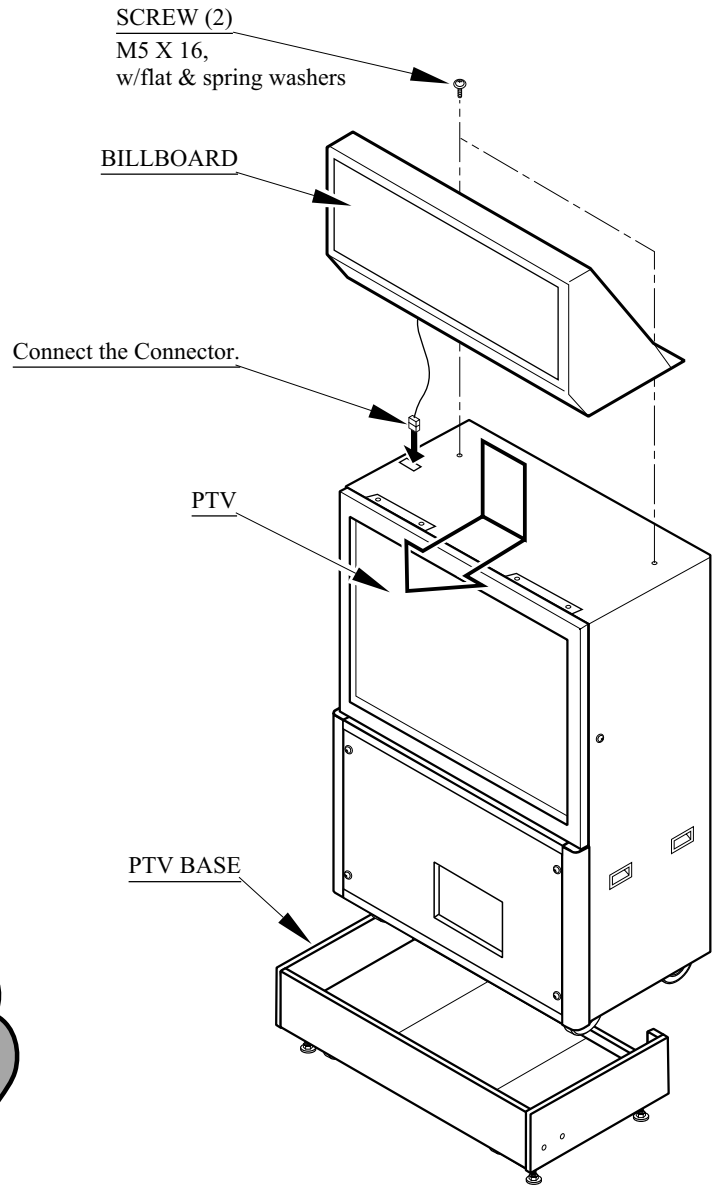
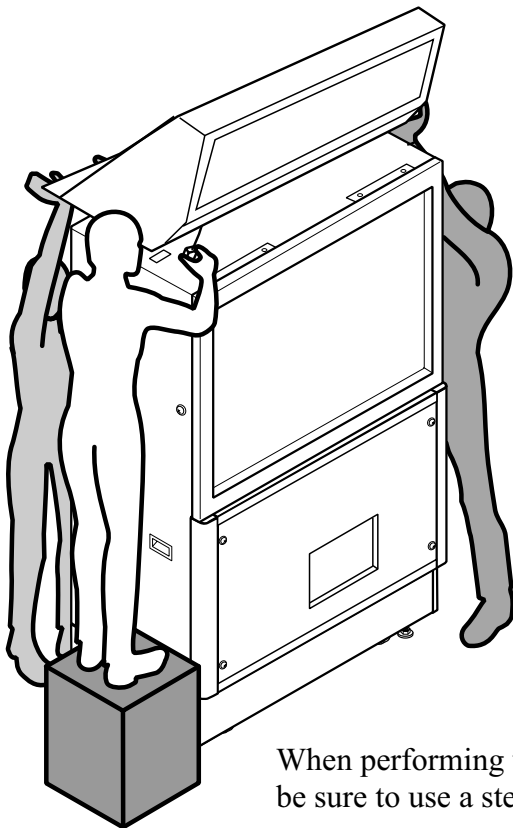

FIG. 6.1 c



When performing work,
be sure to use a step.

FIG. 6.1 d

2

COUPLING THE MAIN CABINET TO THE PTV

- ① Move the main cabinet and the PTV closer to each other. Carefully move the PTV on the PTV base because it is unstable.
- ② Take out the 2 wires from the main cabinet; one for the video signals and another for the power.
- ③ Connect the wires between the main cabinet and the PTV. The connector panel of the PTV front provides two connectors. Into them, insert the 2 wire connectors from the main cabinet; one for the video signals and another for the power. Each has an insertion direction. Make sure about the insertion direction before inserting the connectors, and do not apply excessive force when inserting; otherwise they may be damaged. The connector for the video signals has two fixing screws at its both ends. Tightly fasten them after inserting the connector.

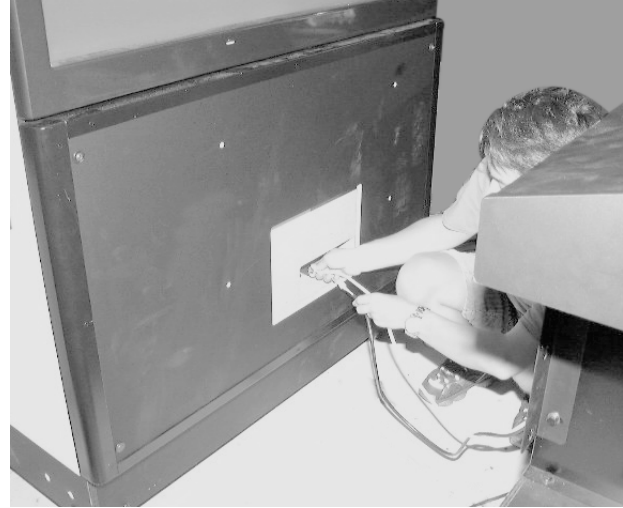

PHOTO 6. 2 a

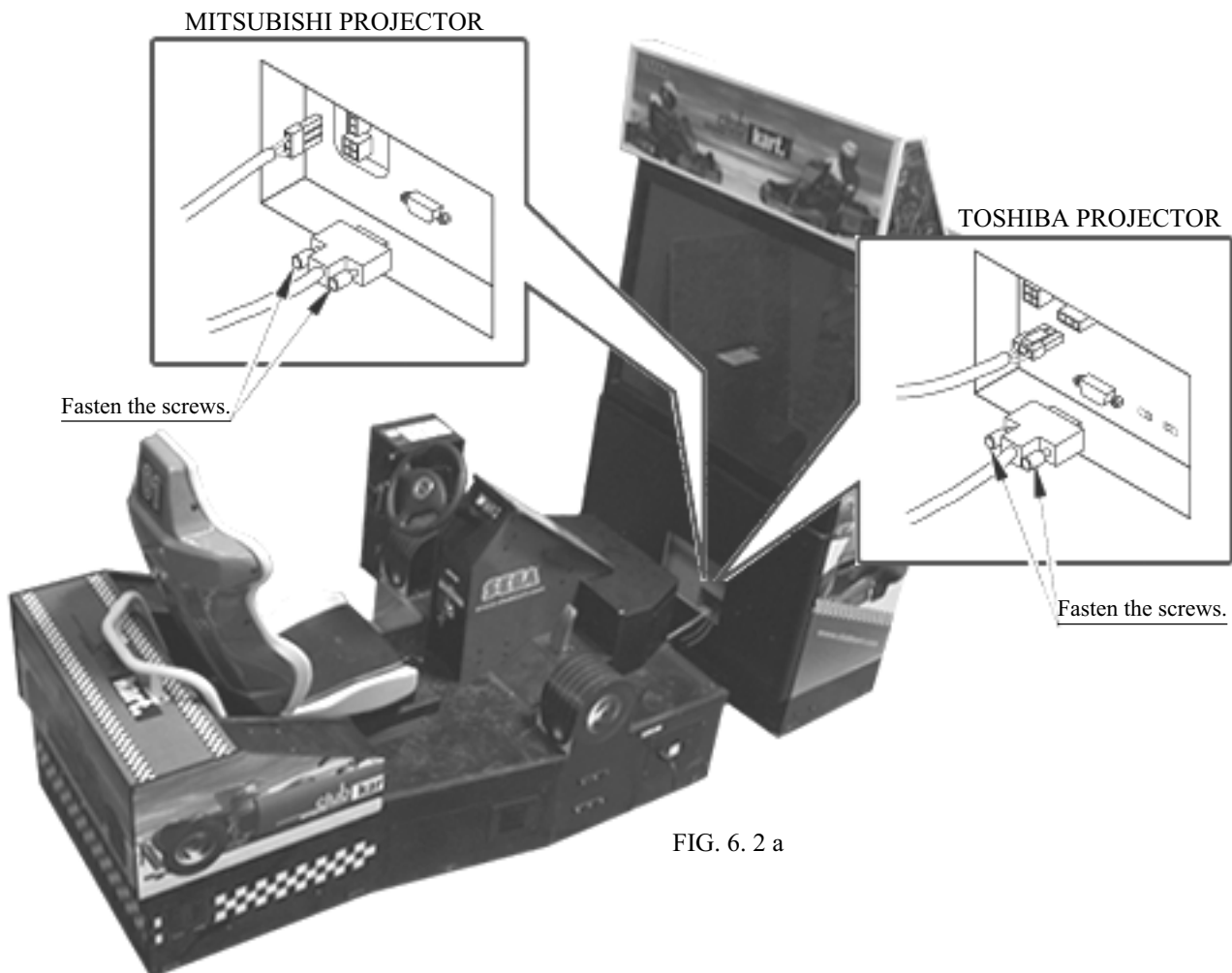

FIG. 6. 2 a

- ④ Remove the 3 trusshead screws to detach the mechanism-side lid from the main cabinet. A square hole appears.
- ⑤ Couple the PTV and the main cabinet with each other. Before attaching them closely without a gap, insert a hand into the square hole and pull the 2 wires into the main cabinet. This will prevent the wires from being caught between them.



PHOTO6. 2 b

- ⑥ Mount the 2 joint bracket centers onto the PTV and the main cabinet. Fix them each with 4 hexagonal-head bolts.
- ⑦ Mount the 2 joint bracket onto the PTV base and the main cabinet. Fix them each with 3 hexagonal-head bolts.
- ⑧ Replace the mechanism-side lid to the main cabinet and fix it with the 3 trusshead screws.

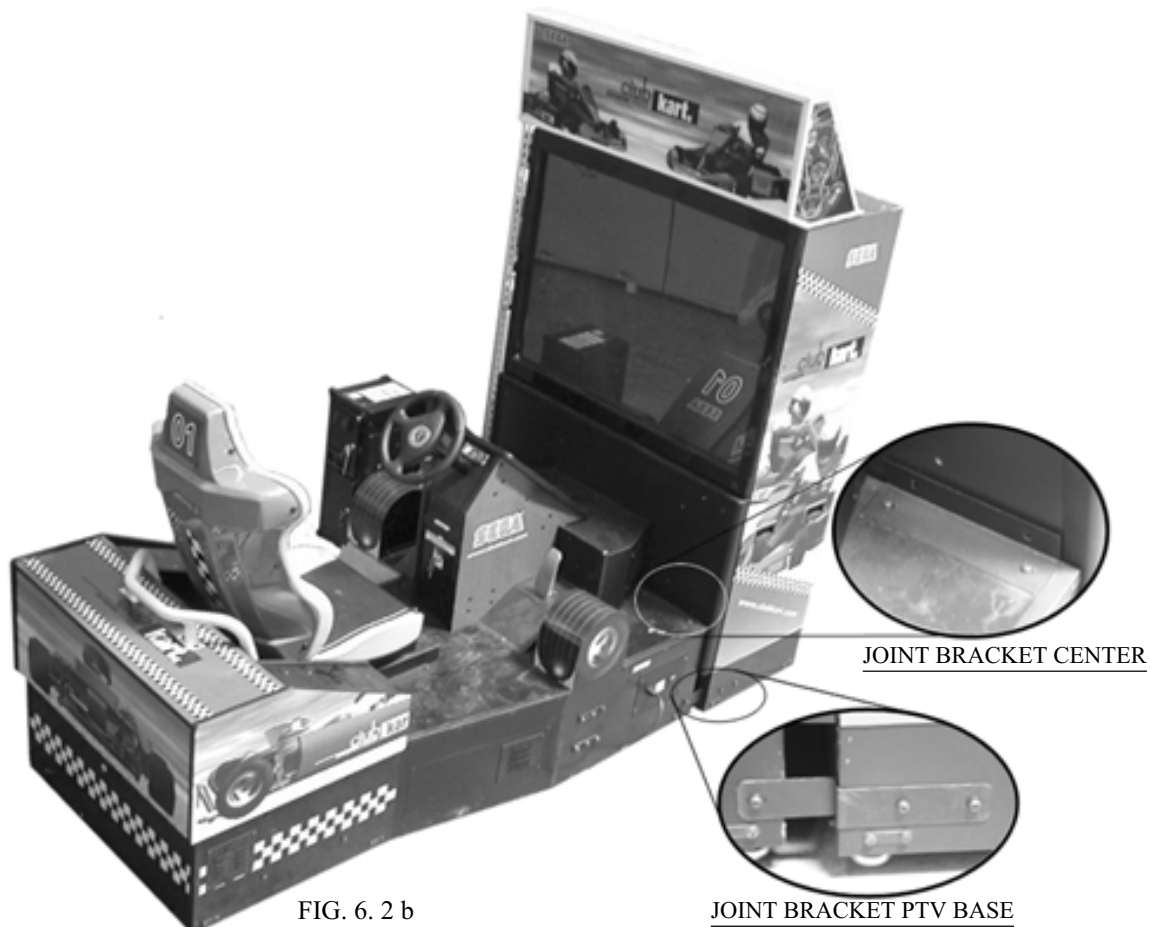

FIG. 6. 2 b

JOINT BRACKET PTV BASE

INSTALLING THE POP

- ① Peel off the double-sided adhesive tape on the POP reverse and stick the POP Holder.
- ② By using the 3 Truss screws, secure the POP Holder to the Billboard ceiling.

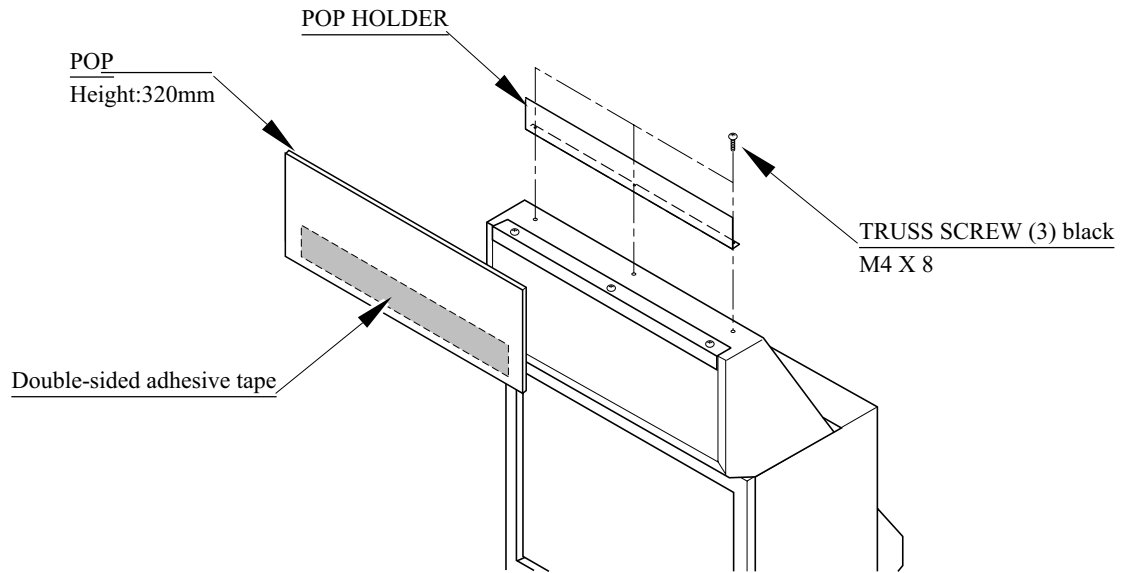

FIG. 6. 2 c

3

SECURING IN PLACE (ADJUSTER ADJUSTMENT)



Make sure that all of the adjusters are in contact with the floor. If they are not, the cabinet can move and cause an accident.

This product has 10 casters (4 for PTV base, 6 for Main Cabinet) and 10 Adjusters (4 for PTV base, 6 for Main Cabinet). (FIG. 6. 3a) When the installation position is determined, cause the adjusters to come into contact with the floor directly, make adjustments in a manner so that the casters will be raised approximately 5mm. from the floor and make sure that the machine position is level.

- ① Transport the product to the installation position. Be sure to provide adequate space allowing the player to get on and off.
- ② Have all of the Adjusters make contact with the floor. Adjust the Adjuster's height by using a wrench so that the machine position is kept level.
- ③ After making adjustment, fasten the Adjuster Nut upward and secure the height of Adjuster (FIG. 6. 3 b).

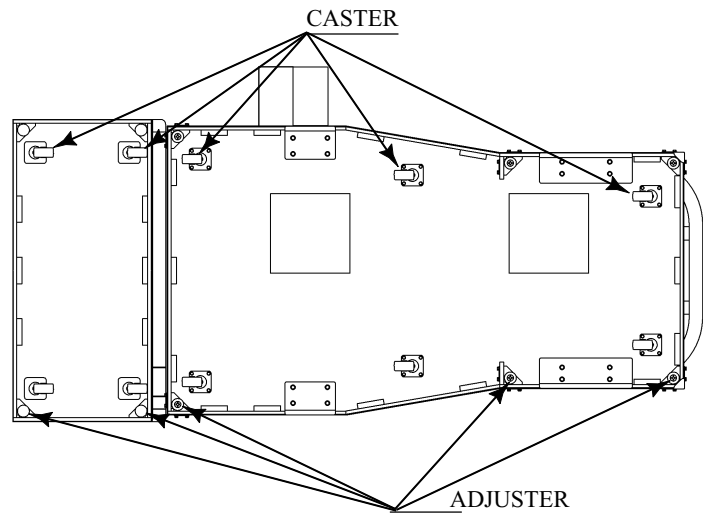

FIG. 6. 3 a BOTTOM VIEW

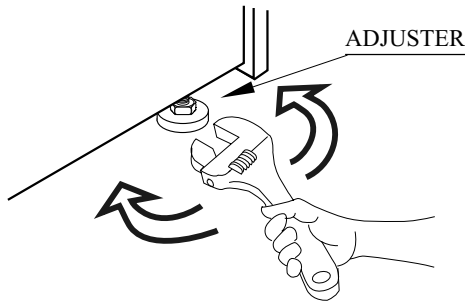

FIG. 6. 3 b ADJUSTER

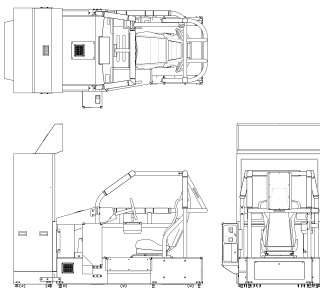
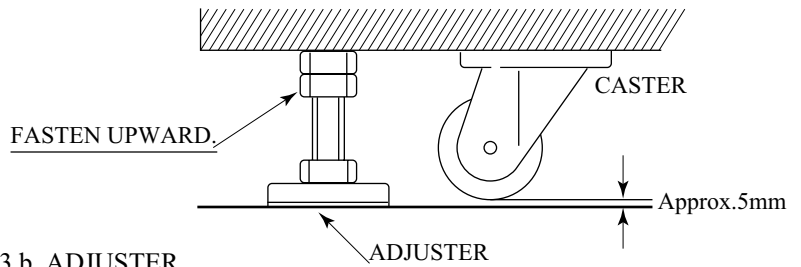

FIG. 6. 3 c
Refer to this Fig. (Scale:1/100) for the layout of the place of installation.

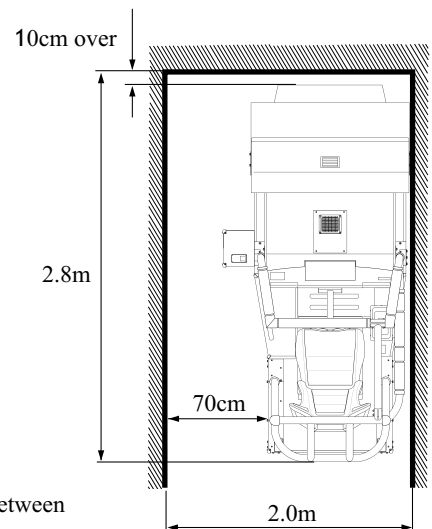

FIG. 6. 3 d
Be sure to provide space as shown between the Air Vent and the wall surface.



POWER SUPPLY



- Be sure to independently use the power supply socket outlet equipped with an Earth Leakage Breaker. Using a power supply without an Earth Leakage Breaker can cause a fire when electric leakage occurs.
- Ensure that the "accurately grounded indoor earth terminal" and the earth wire cable are available (except in the case where a power cord plug with earth is used). This product is equipped with the earth terminal. Connect the earth terminal and the indoor earth terminal with the prepared cable. If the grounding work is not performed appropriately, customers can be subjected to an electric shock, and the product's functioning may not be stable.
- Ensure that the power cord and earth wire are not exposed on the surface (passage, etc.). If exposed, they can be caught and are susceptible to damage. If damaged, the cord and wire can cause electric shock and short circuit accidents. Ensure that the wiring position is not in the customer's passage way or the wiring has protective covering.
- After wiring power cord on the floor, be sure to protect the power cord. Exposed power cord is susceptible to damage and causes an electric shock accident.

The AC Unit is mounted on the right side of the machine. The AC Unit has Main SW, Circuit Protector, Earth Terminal and the Inlet which connects the Power Cord.

- ① Ensure that the Main SW is OFF.

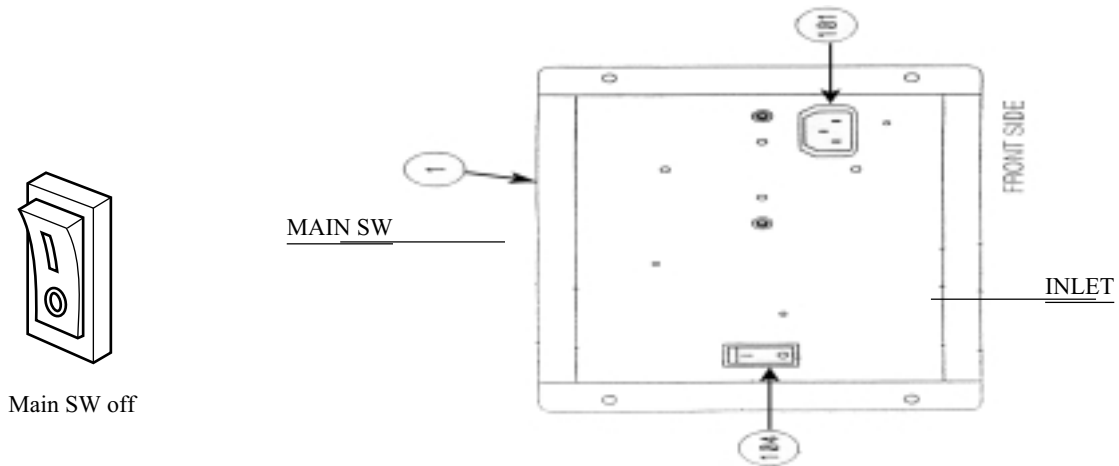
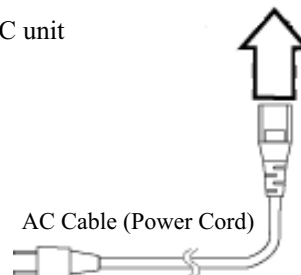
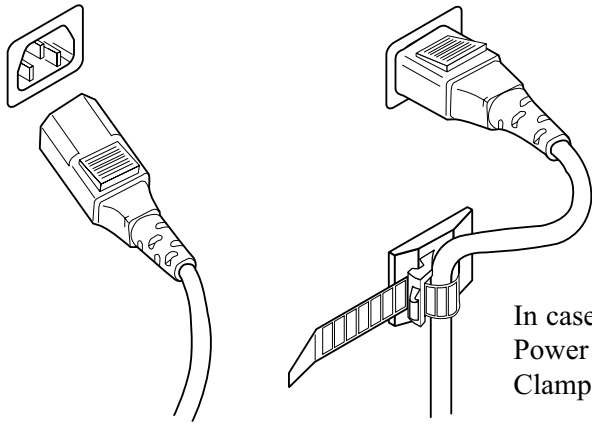

FIG. 6. 4 a AC unit





In case the Power Plug is apt to come out of place, secure the Power Cord to the periphery of the AC Unit with the Cord Clamp (an accessory).

HOW TO USE THE CORD CLAMP

5

TURNING POWER ON

Connect the power by turning on the AC unit's main switch. Then the billboard's fluorescent light comes on.

The monitor (PTV screen) displays a system power-on message, and then an advertising screen (a plying-for-hire screen) appears. At the same time the right and left speakers on the control panel output an advertise sound. The sound is inaudible, however, when you have disabled its function.

Before an advertising screen appears the system automatically conducts an initialization. Do not touch the product until the system completes an initialization and the advertising screen appears. During an initialization the handle (steering wheel) turns counterclockwise and clockwise and stops at the original center position (for a straight-ahead direction). This corrects the volume value inside the control panel. Do not touch the handle or play the game before an initialization is completed (that is, the handle automatically stops at the center position). Failure to observe this may affect the handle's operability and the handle's force feedback (force feedback against crashing) during playing the game. If the handle's operability or force feedback is abnormal, disconnect and reconnect the power for initializing the system again.

When you disconnect the power, the system saves the data for the credit number, ranking, and latest game's score. Assume that the credits effective for playing a game remain when you disconnect the power. In this case, when you will reconnect the power a game startup screen will appear with the start button flashing.

If several machines are interconnected or networked for a communication play, the system checks the network. A network-checking screen as illustrated below appears before an advertising screen appears. Usually, checking the network takes 1 to 3 minutes. If the system detects a problem related with the network, it keeps displaying the network-checking screen or an error message.



FIG. 6. 5 a

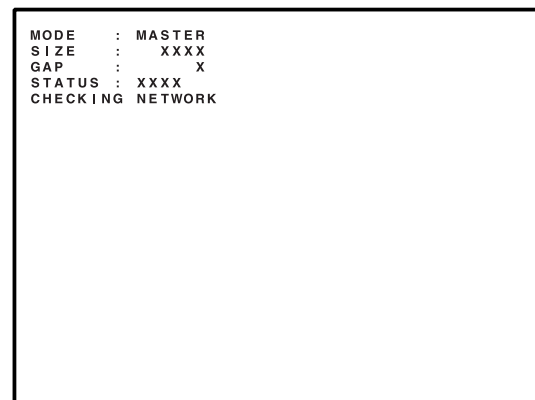

FIG. 6. 5 b NETWORK check screen

6

ASSEMBLING CHECK

In the TEST MODE, ascertain that the assembly has been made correctly and IC BD. is satisfactory (refer to Section 9).

In the test mode, perform the following test:

(1) MEMORY TEST

RAM TEST

IC15 IC16 IC17S IC18S GOOD
IC22 IC23 IC24S IC25S GOOD
IC28 IC29S GOOD
IC41 GOOD
IC42 GOOD
IC44 IC45S IC46 IC47S GOOD
IC91S IC92S GOOD
IC98 GOOD

OPTIONAL SOUND BOARD:
IC2 GOOD

OPTIONAL COMMUNICATION BOARD:
IC7 IC8 IC9 IC10 GOOD

PRESS TEST BUTTON TO EXIT

Selecting the RAM TEST on the system test mode menu screen causes the on-board memory to be tested automatically. The game board is satisfactory if the display beside each IC No. shows GOOD.

(2) C.R.T. TEST

C.R.T. TEST PAGE#1

0 31

RED
GREEN
BLUE
WHITE

PRESS SERVICE BUTTON TO ANOTHER PAGE
PRESS TEST BUTTON TO EXIT

In the system test mode menu, selecting C.R.T. TEST allows the screen (on which the monitor is tested) to be displayed. Although the monitor adjustments have been made at the time of shipment from the factory, color deviation, etc., may occur due to the effect caused by geomagnetism, the location building's steel frames and other game machines in the periphery. By watching the test mode screen, make judgment as to whether an adjustment is needed. If it is necessary, adjust the monitor by referring to Section 13.

C.R.T. TEST PAGE#2

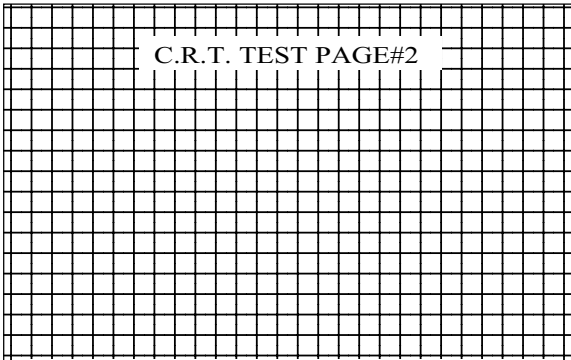

PRESS SERVICE BUTTON TO ANOTHER PAGE
PRESS TEST BUTTON TO EXIT

(3) SOUND TEST

```
SOUND TEST

MAIN SPEAKER LEFT
MAIN SPEAKER RIGHT
OPTION SPEAKER LEFT
OPTION SPEAKER RIGHT
> EXIT

SELECT WITH SERVICE BUTTON
AND
PRESS TEST BUTTON
```

In the system test mode, selecting SOUND TEST causes the screen (on which sound related BD and wiring connections are tested) to be displayed.

Check if the sound is satisfactorily emitted from each speaker and the sound volume is appropriate.

(4) INPUT TEST

```
INPUT TEST

STEERING WHEEL      XXX
GAS PEDAL           XXX
BRAKE PEDAL         XXX
GEAR POSITION         ON
START BUTTON        OFF
VIEW CHANGE BUTTON  OFF

SERVICE SWITCH     OFF
TEST SWITCH         OFF

PRESS TEST AND SERVICE BUTTON TO EXIT
```

Selecting the INPUT TEST on the game test mode menu screen causes the screen (on which each switch is tested) to be displayed. Press each switch. For the coin switch test, insert a coin from the coin inlet with the coin chute door open. If the display beside each switch indicates "ON," the switch and wiring connections are satisfactory.

```
JVS TEST
> DISPLAY CONFIG
EXIT

NODE 1/1
SWITCH
SYSTEM -----
PLAYER1 -----
PLAYER2 -----
COIN
SLOT1 0000 SLOT2 8000
ANALOG
CH1 0000 CH2 0000 CH3 0000 CH4 0000
CH5 0000 CH6 0000 CH7 0000 CH8 0000

SELECT WITH SERVICE BUTTON
AND
PRESS TEST BUTTON
```

(5) OUTPUT TEST

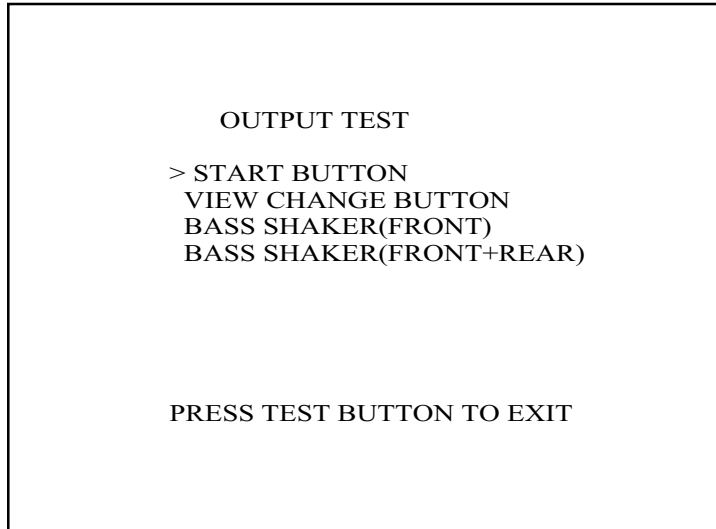

Select OUTPUT TEST from the Menu screen in the Game Test Mode to cause the screen (on which output unit such as lamps and wiring connections are tested) to appear. Ensure that the output unit functions satisfactorily.

Perform the above inspections also at the time of monthly inspection.

7. PRECAUTIONS TO BE HEEDED WHEN MOVING THE MACHINE



WARNING!

- When moving the machine, be sure to unplug the power plug. Moving the machine with the plug as is inserted can damage the power cord and cause fire and electric shock hazards.
- When moving the machine on the floor, retract the Adjusters and ensure that Casters make contact with the floor. During transportation, pay careful attention so that Casters do not tread power cords and earth wires. Damaging the power cords can cause electric shock and short circuit hazards.
- When lifting the cabinet, be sure to hold the grip portions or bottom part. Lifting the cabinet by holding other portions can damage parts and installation portions due to the empty weight of the cabinet, and cause personal injury.
- When transporting the product in places with step-like differences in grade, disassemble into each unit before transporting. Lifting up the product in an attempt to cross the step-like differences in an as is assembled condition may damage the unit's joining portions and cause a personal injury resulting from damage.
- When moving the PTV, do not push it from the rear side. Push it from sideways. Pushing the PTV from the rear side can have the PTV fall down, causing personal injury etc. In case the floor has slanted surfaces or step-like differences, be sure to move the machine by 2 or more persons.
- Do not insert the fork to places other than designated when using a Forklift to transport the machine.
Failure to observe this could cause falling down and injury resulting from falling down.
- Carefully handle the PTV on the PTV base because it is very unstable. If handled carelessly, it may fall down and eventually cause a serious personal injury.



CAUTION!

- Do not push the plastic made parts. Failure to observe this may damage parts and cause injury due to fragments resulting from damage.
- Do not use the handle or lever to move the product. Failure to observe this may cause the parts to be deformed or damaged.



IMPORTANT

- When transporting the product in places with steps, disassemble into each unit before transporting. Inclining the product in an as is assembled condition or placing the cabinet in places with steps can damage the unit's joining portions.
- To protect surface, do not directly apply a rope to the surfaces of product. Use protective materials to the places the rope is applied to.

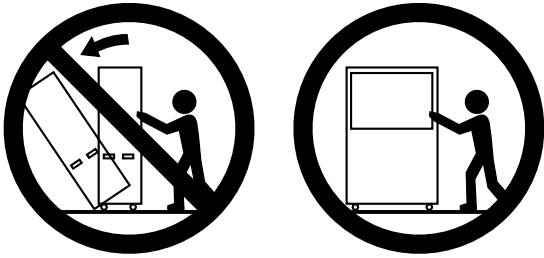

Do not push PTV from the back. Pushing the PTV from the back can cause the PTV to fall down. Push it from the side.

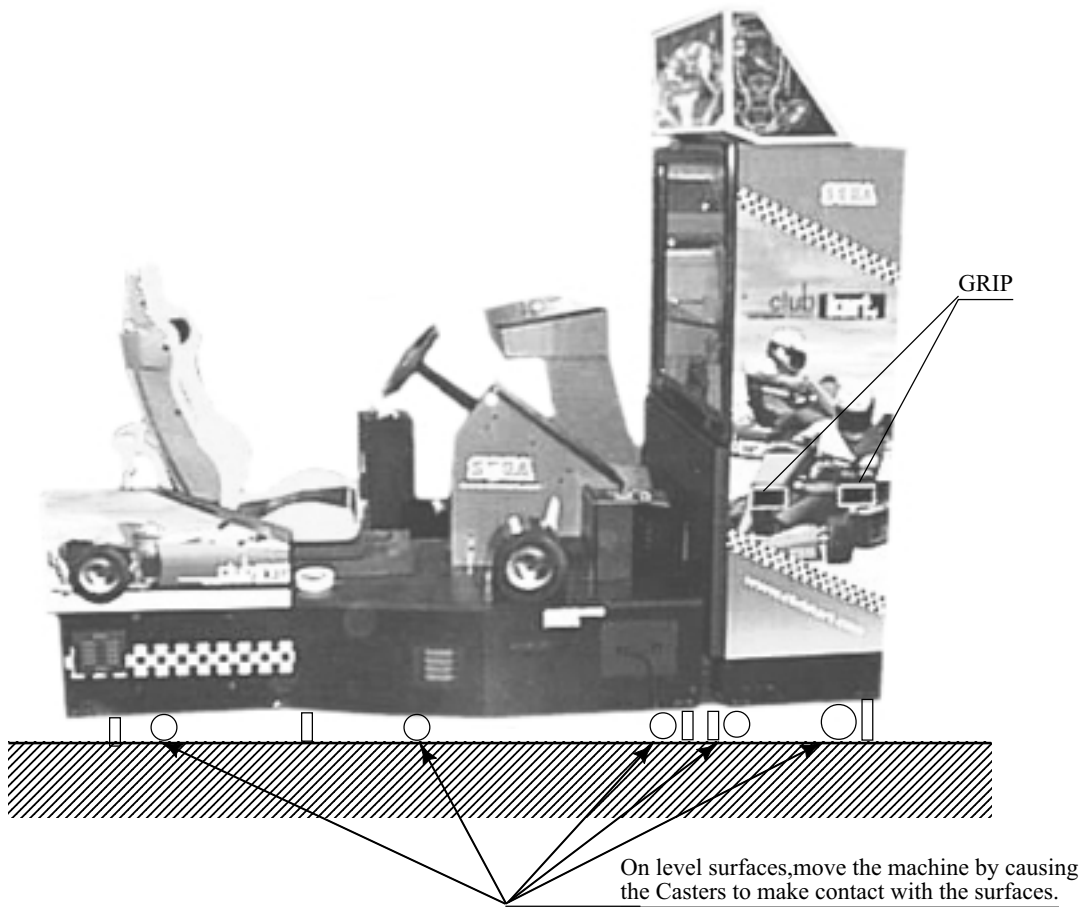

When transporting the product in places with steps or step-like differences in grade, disassemble into each unit before transporting.

When moving the product, use its recessions and bottom parts. Do not hold or push the illustrated parts to move the product.

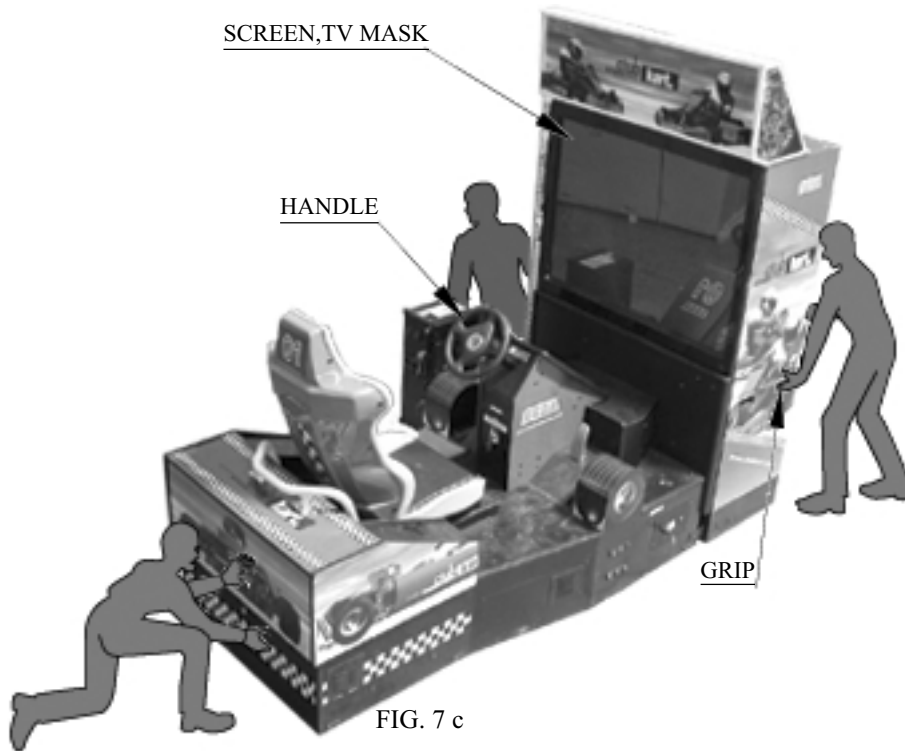

The PTV on the PTV base is very unstable.

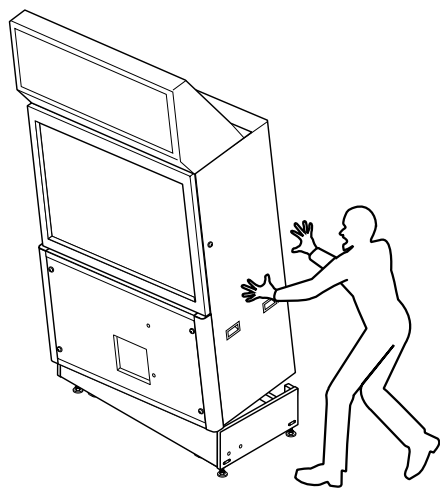

FIG. 7 d

8. CONTENTS OF GAME

The following explanations apply to the case the product is functioning satisfactorily. Should there be any moves different from the following contents, some sort of faults may have occurred. Immediately look into the cause of the fault and eliminate the cause thereof to ensure satisfactory operation.

Advertising (Plying-for-Hire) Performance

The billboard's fluorescent light is always on when the power is connected.

The monitor displays the demonstration images and ranking data. The ranking data is updated every week.

The lights (integrated with the two buttons on the control panel) are off.

The right and left speakers on the control panel output an advertise sound. The right and left speakers on the seat backrest and the bass shaker do not output an advertise sound.

You can activate or deactivate an advertise sound output function on the test mode screen.

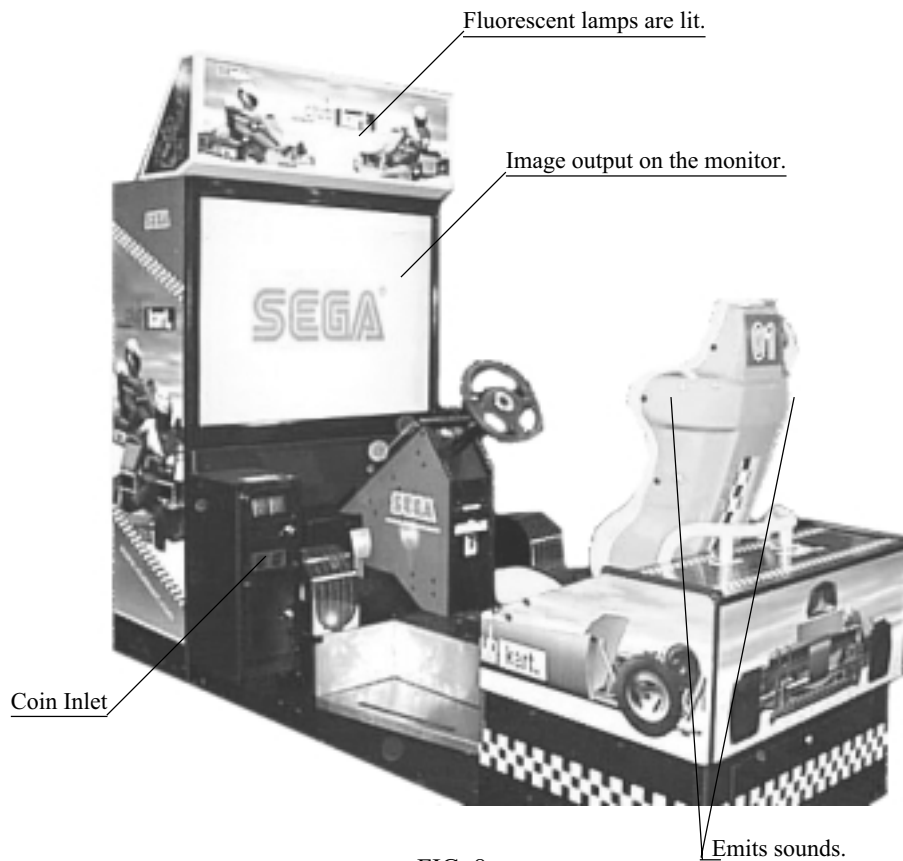

FIG. 8 a

HOW TO PLAY

Operation of a single machine allows a Single Play. Operation of interconnected machines allows a Communication Play.

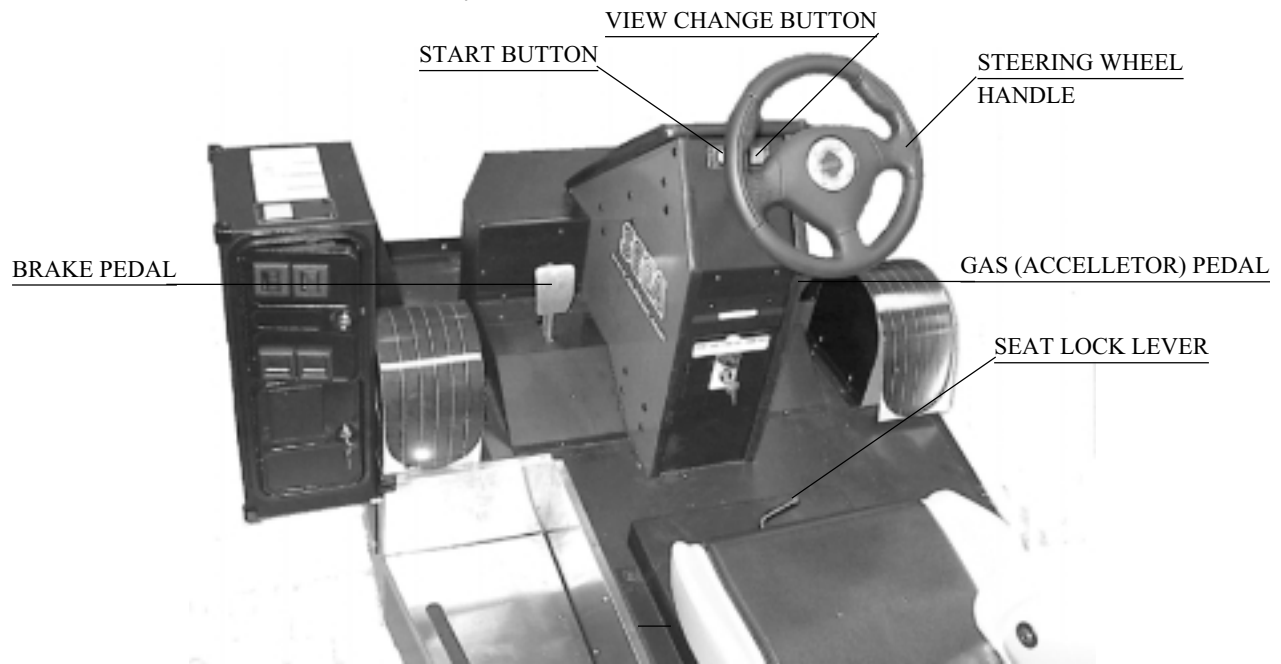
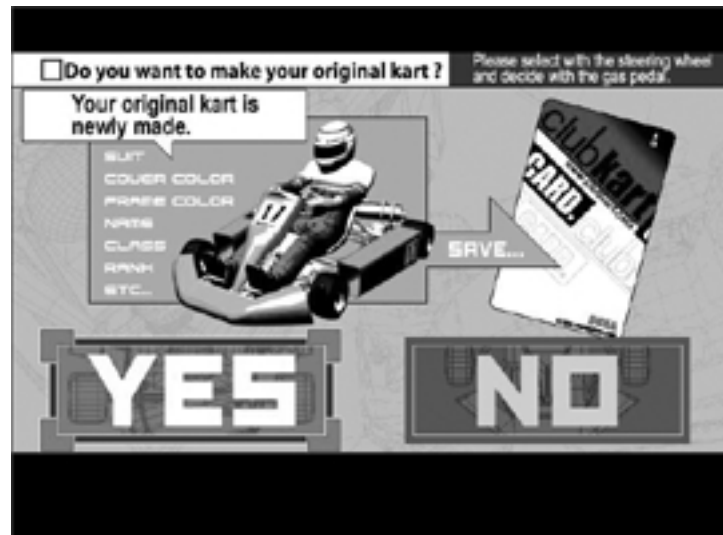

FIG. 8 b

[Single Play]

In this game, the players make their karts and enter the race for competing with each other.



By achieving a good score in the Championship Race mode, you can step up from “Class Novice” (at start) to “Class B,” “Class A,” and “Class S.”

When you step up to a higher class, you may get an extended course along which you can drive, or the performance of the kart with your character may vary. The goal is to win in the race in the environment that may vary in such a manner.

By selecting “Practice Race,” you can select and run along the course for a series of races, if you desire.

This game allows the data to be retained through the cards system. In addition to the kart’s name, frame, cowl, suits, helmet, etc., information such as the total time, achievements in a series of races, the highest rank by class can be recorded on the “Club Kart Card” (hereafter “CARD”).

How to Play the Game --- If you play the Championship Race for the first time:

- Throw coins into the slot. At this time, the value converted for the number of credits is displayed at the bottom right corner of the screen.

When you throw into the slot the number of coins enabling operation of one play session, you go to the screen that asks whether you have a card.

- In response to the inquiry, “Do you want to create a new card?”
- If you answer with “NO,” or you do not insert any card after you answer with “YES,” Rental Kart is automatically selected as the type of the kart you can use. In this case, you go to Step 1 (creating a new card). One more credit is required in this case.
- If you throw a card into the slot without making the selection, you will go to selection of the Race Mode.

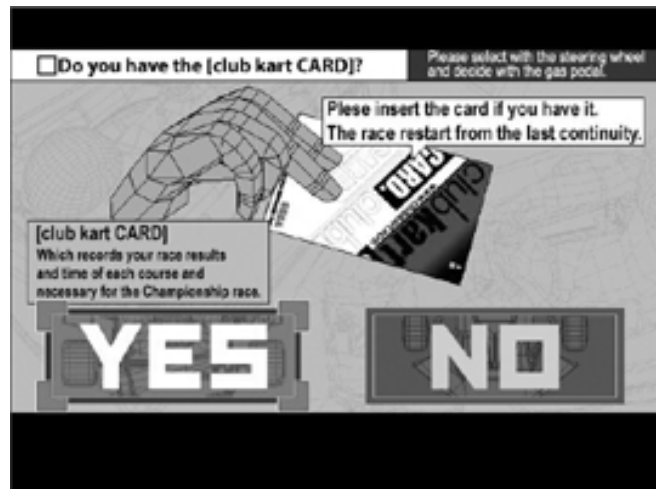

Rental Kart Mode

In the Rental Kart Mode, you select and run along the desired one of four courses for competition in lap time. You choose either one of two types of karts: for the novice and middle classes. You are required to make the specified number of circuits of the course within the predetermined time-out time.

- Once you complete the first circuit, the remaining time of the time-out time for the first circuit is added to the time-out time for the second circuit.
- When you complete the specified number of circuits of the course within the specified time, the finish takes place. When the time-out time reaches 0, Game Over takes place.

An example where “YES” was selected is described in this document.

- Create a new card.

After entering the name, select the cowl, frame, and racing suite colors and the helmet design according to the instructions on the screen.

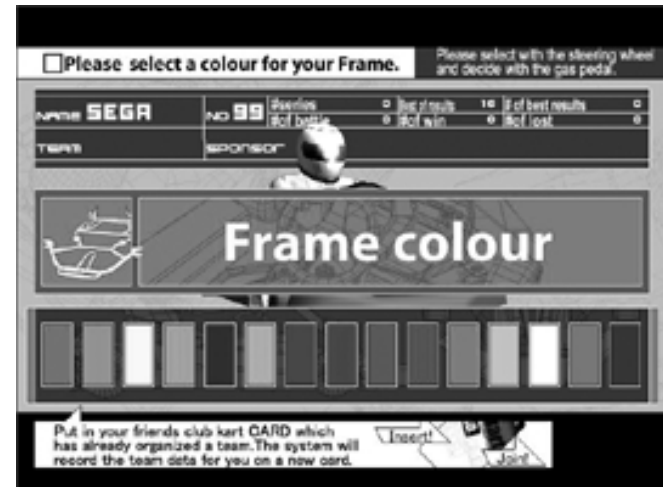
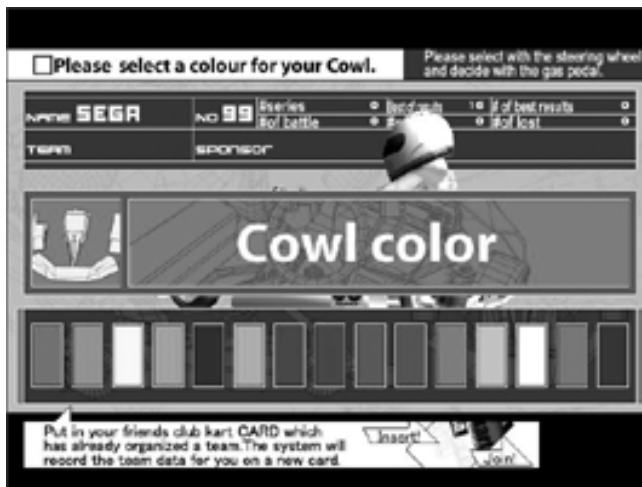
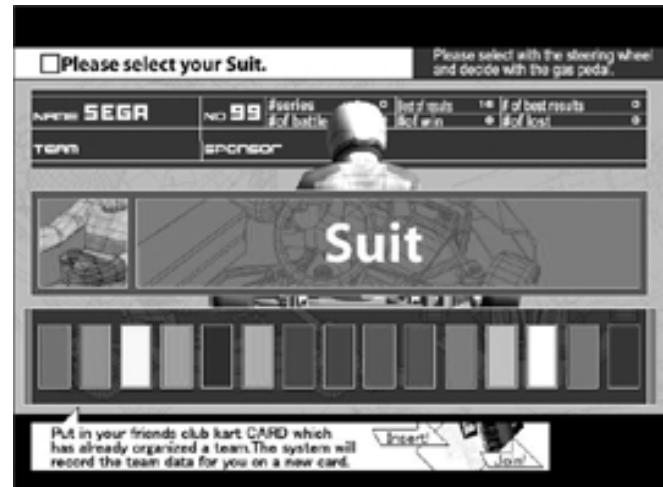

- After you have entered all the information, you go to the confirmation screen and must make operations according to the instructions on the screen.

- Select the Race Mode.

You can choose either Championship Race or Practice Race. (“Communicated Race” is additionally displayed when two or more machines are interconnected.) Turn the steering wheel clockwise or counterclockwise for selection. Then, determine the selection by pressing the accelerator pedal.



Championship Race

• In this mode, you compete with the other players for the total achievement of a Series of Races that are done, depending on four classes (Novice, B, A, and S). The race in this mode begins after you have created the feature of creating your own original kart (one of the distinctive features of this game) and the card to save the running record.

With the card, you can save the data before completion of the series of races; at the next play time, you can resume the game from the ending point in the previous session of the game.

Practice Race

You can select and run along the desired one of the courses along which you run in a Series of Races.

The number of courses from among which can select depends on the number of races included in the series, which varies with the class to which you belong (4 of Novice, 6 for B, 8 for Class, and 10 for S).

• Information about the player's kart (class, the number fo times won and defeated, the top ranking, the best time, the number of races in the series, etc.) and the course map are displayed before the race starts.

When you created a card for the first time, the player's kart starts at the rearmost position.

You are required to make the specified number of circuits of the course within the predetermined time-out time. Once you complete the first circuit, the remaining time of the time-out time for the first circuit is added to the time-out time for the second circuit. When you complete the specified number of circuits of the course within the specified time, the finish takes place. When the time-out time reaches 0, Game Over takes place.

• If your kart touches the wall of the course or another kart or goes outside the course while the game is in progress, you feel a reaction through the steering wheel.

• While the game is in progress, pressing the Viewpoint Change button changes the viewpoint on the screen. The button is continually flashing while the game is in progress.

• While the game is in progress, pressing the Start button toggles between the map that shows the player kart's and the time display that indicates the other karts' positions and the best time in the class and that of your records.

• After each race is completed, the Results Screen appears if you have run along the whole course. After the Results Screen appears, the Select Sponsor Screen may appear, depending on the results of the series of races. The number of sponsors, at random, increases or decreases, depending on the achievement. The logo of the sponsor you selected can be attended to the kart if you desire this.

When Select Sponsor Screen appears for the first time, you assign the team name to your kart.

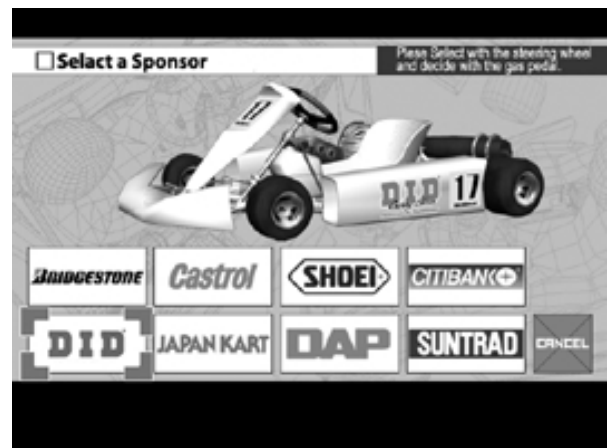

- For a Series of Races, the total achievements are listed when the predetermined number of races have been completed for each of the classes. If you have established good achievement, a screen appears that lets you select whether to try the next series of races at the current or upper class.



- If the Practice Race Mode is entered or all the credits have been exhausted after the data is written onto the card after completion, Game Over takes place. If you are in the Championship Race Mode, you go to the Continue Screen. If you still have credits for one or more play sessions at this time in the Championship Race Mode, you can go to the next course and enjoy one or more play sessions after jumping to the course map display is Step ???.

[Communicated Play]

Communicated Play differs slightly from Single Play regarding the game starting procedure and how to play the game.

- When coins you throw into the slot the coins with which you can enjoy a play session, the Entry Screen appears and, at the same time, the Start button begins to flash.
- If you desire a competitive play, throw the appropriate number of coins into the slot at another seat. If you desire the single play mode, press the Start button immediately after the Entry Screen appears.
- Once the Entry Screen appears, a countdown starts. If a person who desires to compete with you does not appear before the count reaches 0 (zero), you have to enjoy the game in the Single Play Mode.
- Once the count in the Entry Screen reaches 0, you are brought to the Select Rental Kart Screen. Turn the steering wheel clockwise or counterclockwise to choose selection by pressing the accelerator pedal and Start button. If you have a card, you will be subsequently able to use your own original kart by inserting the card into the slot. The course assignments to the players are determined by majority of the players.
- Once the course assignments are determined, information about the players' karts (class, the number of times won and defeated, the top ranking, the best time, the number of races in the series, etc.) and the course map are displayed before the race starts.
- In the race, the players compete with each other for their ranks. Each time the first-rank player completes one circuit of the course, the time that remained is added to that of the next circuit of the course. When you complete the specified number of circuits of the course within the specified time, the finish takes place. When the time-out time reaches 0, Game Over takes place.
- STEERING DIR
This is a setting about the cabinet. Basically, you do not need to change it. You should use the factory-adjusted setting.
- CARD SYSTEM
This sets the mode of operation for the card system unit. For usual operation, set ENABLE. If the card system unit is detached from the system, set DISABLE.
- BONUS GAMES
This sets the count of plays given as a bonus when a new card is created. By setting this, the count can be set to 0 to 3 times.

9. EXPLANATION OF TEST AND DATA DISPLAY

By operating the switch unit, periodically perform the tests and data check. When installing the machine initially or collecting cash, or when the machine does not function correctly, perform checking in accordance with the explanations given in this section.

The following shows tests and modes that should be utilized as applicable.

SEGA HIKARU GAME BOARD is used for the product. The system of this game board allows another game to be played by replacing the ROM Board Case mounted on the SEGA HIKARU CASE. As such, the Test Mode of this system consists of the System Test Mode for the system to execute SELF-TEST, COIN ASSIGNMENTS, etc. used in common for the machines employing the SEGA HIKARU BOARD, and the Game Test Mode for the specific product to execute Input/Output test for the operation equipment, difficulty setting, etc.



- The contents of settings changed in the TEST mode are stored when the test mode is finished from EXIT in the menu mode. If the power is turned off before the TEST mode is finished, the contents of setting change become ineffective.
- Executing "BACKUP DATA CLEAR" in the SYSTEM TEST MODE does not clear the BOOKKEEPING data in the GAME TEST mode.
- Entering the TEST mode clears fractional number of coins less than one credit and BONUS ADDER data.
- When the 2 or more machines are linked for communication play, be careful to enter the test mode. If one of the machines linked enters the test mode, all others display the NETWORK CHECK screen.

TABLE 9 EXPLANATION OF TEST MODE

ITEMS	DESCRIPTION	REFERENCE SECTIONS
INSTALLATION OF MACHINE	When the machine is installed, perform the following: 1. Check to see that each setting is as per standard setting made at the time of shipment. 2. In the INPUT TEST mode, check such input devices as each SW, V.R., etc. 3. In the OUTPUT TEST mode, check such output devices as lamps, motors, etc. 4. In the SELF-TEST mode, check ICs on the IC Board.	9-2 F,G, 9-3 F 9-2 C, 9-3 B 9-3 C 9-2 B,J
MEMORY	Choose MEMORY TEST in the MENU mode to allow the MEMORY test to be performed. In this test, PROGRAM RAMs, ROMs, and ICs on the IC Board are checked.	9-2 B,J
PERIODIC SERVICING	Periodically perform the following: 1. MEMORY TEST 2. Ascertain each setting. 3. In the INPUT TEST mode, test the CONTROL device 4. In the OUTPUT TEST mode, check such output devices as lamps, motors, etc.	9-2 B,J 9-2 F,G, 9-3 F 9-2 C, 9-3 B 9-3 C
CONTROL SYSTEM	1. In the INPUT TEST mode, check such input devices as each SW, V.R., etc. 2. Adjust or replace each SW and VR. 3. If the problem can not be solved yet, check the CONTROL's moves.	9-2 C, 9-3 B 9-3 D,E, 10,11,12
MONITOR	In the MONITOR ADJUSTMENT mode, check to see if the PROJECTOR adjustment is appropriately made.	9-2 E 13
IC BOARD	1. MEMORY TEST 2. In the SOUND TEST mode, check the sound related ROMs.	9-2 B,J 9-2 D
DATA CHECK	Check such data as game play time and histogram to adjust the difficulty level, etc.	9-2 H, 9-3 G

9 - 1 SWITCH UNIT AND COIN METER



WARNING!

Never touch places other than those specified. Touching places not specified can cause electric shock and short circuit hazards.



IMPORTANT

- Adjust to the optimum sound volume by considering the environmental requirements of the installation location.
- If the COIN METER and the game board are electrically disconnected, game play is not possible.
- A cover is provided on the bass shaker output adjustment volume in order to prevent the BASE SHAKER against being carelessly adjusted.

SWITCH UNIT

Open the coin chute door, and the switch unit shown will appear.

The functioning of each SW is as follows:

The sound volumes of the front and rear speakers are adjusted as indicated by the illustration on the switch unit, at the factory before shipping. This adjustment aims to attain the best output balance between the front and rear speakers. Remember that carelessly changing this adjustment may cause the best balance to be lost.

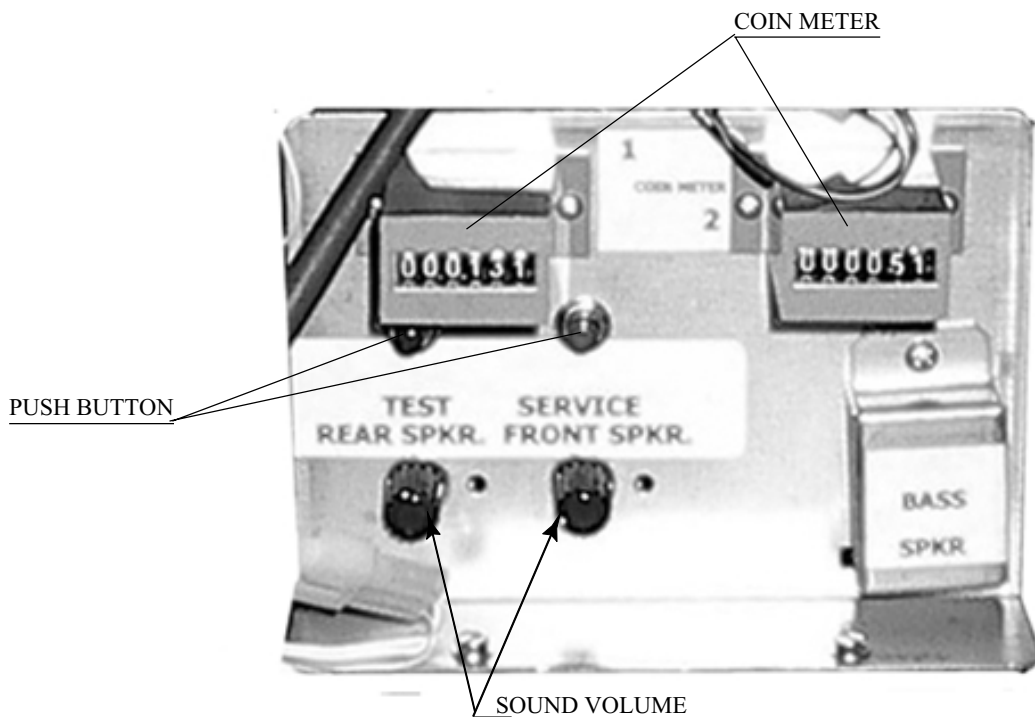

FIG. 9. 1 a SWITCH UNIT

- TEST BUTTON : For the handling of the test button, refer to the following pages.
 TEST
- SERVICE BUTTON : Gives credits without registering on the coin meter.
 SERVICE
- SOUND VOLUME : Adjusts the sound volume of the left and right speakers on the control panel.
 FRONT SPEAKER
- SOUND VOLUME : Adjusts the sound volume of the left and right speakers on the seat backrest.
 REAR SPEAKER
- BASE SHAKER Output Adjustment Volume : Adjusts the vibration output of the base shakers each on
 BASS SHEAKER the seat backrest and the control panel.

COIN METER

Open the Cashbox Door by using the key to have the Coin Meter appear underneath the Cashbox.

COIN METER

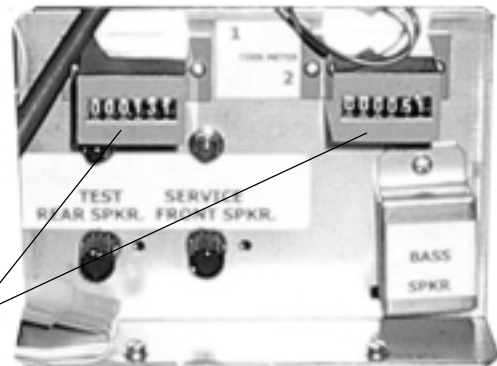

FIG. 9. 1 b COIN METER

9 - 2 SYSTEM TEST MODE



The contents of setting changes in SYSTEM ASSIGNMENTS, COIN ASSIGNMENTS, and GAME TEST MODE are stored when the test mode is EXITed. If the power is turned off before EXITing, the contents of setting changes are ineffective. Be very careful of this point.

This test mode mainly allows the IC Board to be checked for accurate functioning, monitor color to be adjusted as well as COIN ASSIGNMENTS and GAME ASSIGNMENTS to be adjusted.

TEST ITEM SELECT

- ① After turning power on, press the TEST button to have the following test item menu displayed.

```
SYSTEM MENU

RAM TEST
JVS TEST
SOUND TEST
C.R.T. TEST
SYSTEM ASSIGNMENTS
COIN ASSIGNMENTS
BOOKKEEPING
BACKUP DATA CLEAR
CLOCK SETTING

ROM BOARD TEST
GAME TEST MODE
[XXXXXXXXXXXXXXXXXX]

-> EXIT

SELECT WITH SERVICE BUTTON
AND PRESS TEST BUTTON
```

- ② Press the SERVICE button to move the arrow. Bring the arrow to the desired item and press the TEST button.
- ③ Upon finishing the test, bring the arrow to EXIT and press the TEST button to return to the Game mode.

A. RAM TEST

This allows for checking the functioning of the RAM on the NAOMI 2 Main BD.
"GOOD" is displayed for satisfactory RAMs, and "BAD" is indicated for irregular RAMs, if any.

```
RAM TEST
TESTING NOW
IC29 GOOD
IC35 GOOD
IC09 GOOD IC10 GOOD
IC11 GOOD IC12 GOOD
IC16 GOOD IC18 GOOD
IC20 GOOD IC22 GOOD
IC17 GOOD IC19 GOOD
IC21 GOOD IC23 GOOD
IC106 GOOD IC107 GOOD
IC108 GOOD IC109 GOOD
IC111 GOOD IC113 GOOD
IC115 GOOD IC117 GOOD
IC112 GOOD IC114 GOOD
IC116 GOOD IC118 GOOD
PRESS TEST BUTTON TO EXIT
```

"TESTING NOW" shows up (flashing) on the screen during the test.
Returns to the menu screen when the TEST button is pressed after the test is over.

B. JVS TEST

In this test, Specifications of the I/O Board connected to NAOMI 2 can be checked, and INPUT TEST can be performed. First, I/O Board Specifications are displayed.

<pre> JVS TEST INPUT TEST NEXT NODE -> EXIT </pre>		(A)	
NODE	1/1	(B)	
NAME	SEGA ENTERPRISES,LTD.	(C)	
	I/O BD JVS		1 2 3
	837-13551		Name and version of I/O BOARD.
	Ver 1.00		
CMD VER	1.1		
JVS VER	2.0		
COM VER	1.0		
SWITCH	2PLAYER(S) 13BITS		
COIN	2SLOT		
ANALOG	8CH		
ROTARY	0CH		
KEYCODE	0		
SCREEN	X:0 Y:0 CH:0		
CARD	OSLOT		
HOPPER OUT	0CH		
DRIVER OUT	6SLOT		
ANALOG OUT	0CH		
CHARACTER	CHARA:0 LINE:0		
BACKUP	0		
<p>SELECT WITH SERVICE BUTTON AND PRESS TEST BUTTON</p>			

Select with the SERVICE button and press the TEST button.

- (A) INPUT TEST : Proceeds to the INPUT TEST of I/O BOARD being displayed.
- (B) NEXT NODE : In the case where more than 2 I/O Boards are connected, proceeds to the next I/O Board.
- (C) EXIT : Returns to the menu mode.

INPUT TEST SCREEN

<pre> JVS TEST INPUT TEST NEXT NODE -> EXIT </pre>		
NODE	1/1	
SWITCH	_____	▶ When INPUT is performed for the switches of Control Panel, etc., the value changes to 1 from 0.
SYSTEM	00000000	
PLAYER1	00000000	
	00000000	
PLAYER2	00000000	
	00000000	
COIN	_____	▶ If the Coin SW is inputted, the count starts. When the TEST MODE is finished, the count is cleared and returned to[0000].
	0000 0000	
ANALOG	_____	▶ Analogue values are displayed between 0000 and FF00.
	0000 0000 0000 0000	
	0000 0000 0000 0000	
<p>SELECT WITH SERVICE BUTTON AND PRESS TEST BUTTON</p>		

C. SOUND TEST

Sound Output test can be performed. Beep sounds can be emitted from each of left/right Speakers.

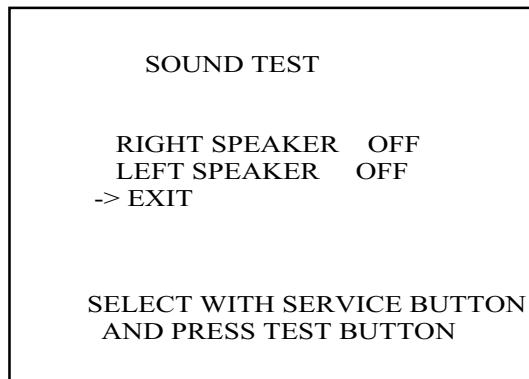

- Emitted from the right-hand side Speaker.
- Emitted from the left-hand side Speaker.
- Returns to the menu mode.

D. C.R.T. TEST

1) RGB COLOR ADJUSTMENT SCREEN

In this page, monitor color can be checked.

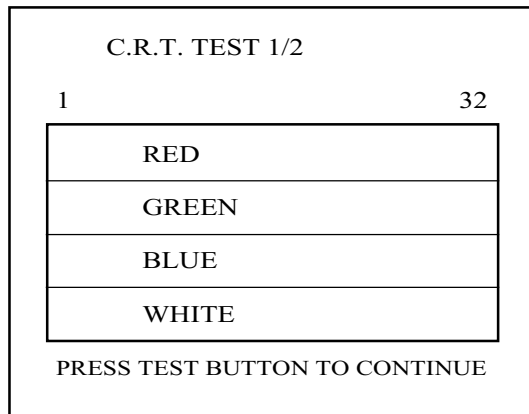

Each of red, green, and blue is the darkest at the leftmost end, and becomes brighter towards the right-hand end in 31 gradations. Monitor brightness is satisfactory if the white color bar is black at the left end and if it is white at the right end.

Press the TEST button to proceed to the next page.

2) MONITOR SIZE ADJUSTMENT SCREEN

In this page, monitor size can be checked.

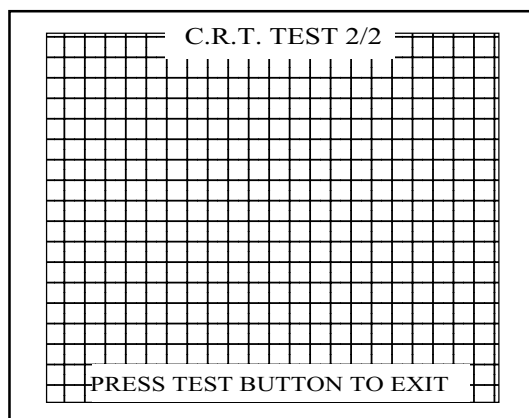

Adjust so that the checkered patterns do not go beyond the screen.

Press the TEST button to return to the menu mode.

E. SYSTEM ASSIGNMENTS

The settings of cabinet and board can be changed. Game related assignments such as game difficulty, etc. are performed in K. GAME TEST MODE.

- ① Press the SERVICE button to move the arrow. Bring the arrow to the desired item.
- ② Press the TEST button to change the setting.
- ③ Upon finishing the setting, move the arrow to EXIT and press the TEST button.

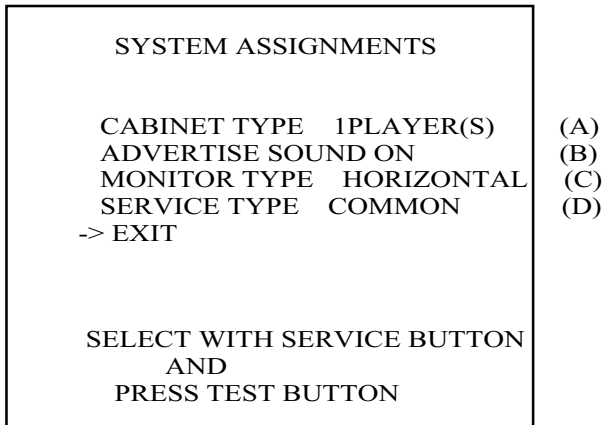

(A) CABINET TYPE (1PLAYER(S), 2PLAYER(S), 3PLAYER(S), 4PLAYER(S))

Sets the number of players between 1 and 4.
Fix setting to 1 PLAYER(S).

(B) ADVERTISE SOUND (ON, OFF)

Sets whether ADVERTISE sound is to be emitted or not.

(C) MONITOR TYPE (HORIZONTAL, VERTICAL)

Sets the on-screen display to the positional direction of monitor (HORIZONTAL/VERTICAL)
Fix setting to HORIZONTAL.

HORIZONTAL: Normal on-screen display

VERTICAL: On-screen display when the monitor is vertically positioned as against normal HORIZONTAL position.

(D) SERVICE TYPE (COMMON, INDIVIDUAL)

Sets the functioning of when the SERVICE button is pressed, in case that several SERVICE buttons exist.

Fix setting to COMMON.

COMMON: By pressing any SERVICE button, Service credit can be obtained for all Players.

INDIVIDUAL: By pressing SERVICE button, Service credit can be obtained for the Player corresponding to the SERVICE button pressed.

F. COIN ASSIGNMENTS

In this mode, the setting of incremental credit increase as against coin insertion can be changed.

- ① Press the SERVICE button to move the arrow. Bring the arrow to the desired item.
- ② Press the TEST button to change the setting.
- ③ Upon finishing the setting, bring the arrow to EXIT and press the TEST button.

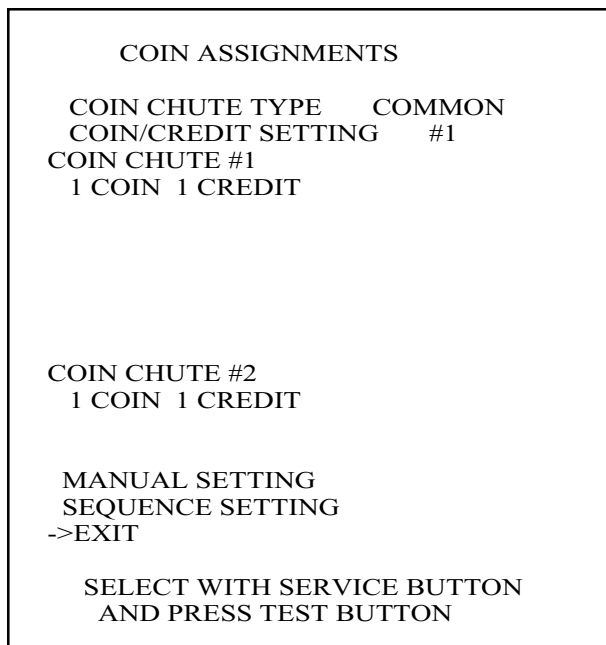

Setting to COMMON

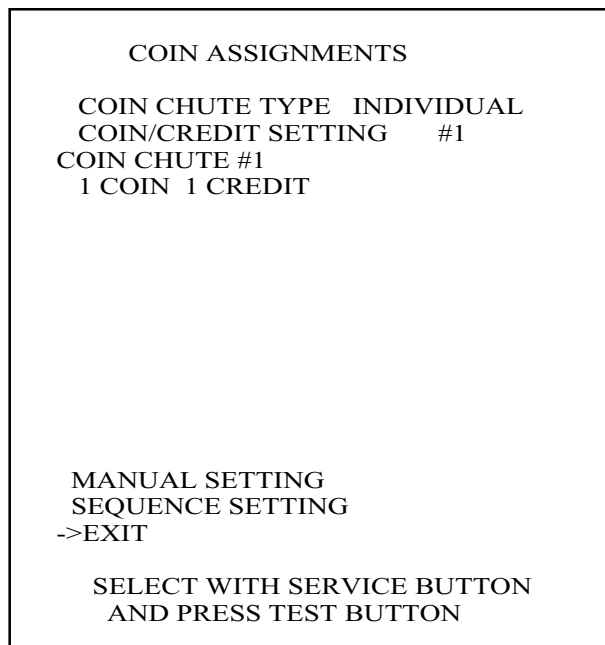

Setting to INDIVIDUAL

(A) COIN CHUTE TYPE (COMMON, INDIVIDUAL)

Fix setting to COMMON.

COMMON

This setting is for the cabinet which has a coin chute(s) for common use by plural players. Up to 2 Coin Chutes (#1 and #2) can be used and also, (B) COIN/CREDIT SETTING ratio can be set separately for #1 and #2.

INDIVIDUAL

This setting is for the cabinet in which each player uses an independent coin chute. Coins inserted by each player are handled as the player's credits. Depending on the CABINET TYPE setting in the SYSTEM ASSIGNMENTS and the functioning of the connected I/O Board, the number of Coin SW INPUT ports varies between 1 and 4. (B) COIN/CREDIT SETTING ratio is common for each Coin Chute.

(B) COIN/CREDIT SETTING (# 1 ~ # 27)

Sets the credit increase increment per coin insertion. There are 27 settings from #1 to #27, expressed in ○○ credit(s) as against ○○ coins inserted. #27 refers to FREE PLAY. For details, refer to Table 1 (COMMON) and Table 2 (INDIVIDUAL).

(C) MANUAL SETTING

The Credit's incremental increase settings as against a coin insertion are shown in further details than in (B) above (refer to Table 3). Also, note that when this MANUAL SETTING is performed, (B) COIN CREDIT setting becomes ineffective.

MANUAL SETTING

```

COIN ASSIGNMENTS
MANUAL SETTING

COIN TO CREDIT      1
BONUS ADDER        NO BONUS ADDER
COIN CHUTE #1 MULTIPLIER
1 COIN COUNT AS 1 COIN
COIN  1 2 3 4 5 6 7 8 9
CREDIT 1 2 3 4 5 6 7 8 9

COIN CHUTE #2 MULTIPLIER
1 COIN COUNT AS 1 COIN
COIN  1 2 3 4 5 6 7 8 9
CREDIT 1 2 3 4 5 6 7 8 9

SEQUENCE SETTING

->EXIT

SELECT WITH SERVICE BUTTON
AND PRESS TEST BUTTON

```

Setting to COMMON

```

COIN ASSIGNMENTS
MANUAL SETTING

COIN TO CREDIT      1
BONUS ADDER        NO BONUS ADDER
COIN CHUTE MULTIPLIER
1 COIN COUNT AS 1 COIN
COIN  1 2 3 4 5 6 7 8 9
CREDIT 1 2 3 4 5 6 7 8 9

SEQUENCE SETTING

->EXIT

SELECT WITH SERVICE BUTTON
AND
PRESS TEST BUTTON

```

Setting to INDIVIDUAL

(D) COIN TO CREDIT

Determines COIN/CREDIT setting.

(E) BONUS ADDER

This sets how many coins should be inserted to obtain one SERVICE COIN.

(F) COIN CHUTE (# 1 / # 2) MULTIPLIER

This sets how many tokens one coin represents.

Table 1: COIN/CREDIT SETTING (COIN CHUTE COMMON TYPE)

NAME OF SETTING	COIN CHUTE 1		COIN CHUTE 2	
SETTING #1	1 COIN	1 CREDIT	1 COIN	1 CREDIT
SETTING #2	1 COIN	2 CREDITS	1 COIN	1 CREDIT
SETTING #3	1 COIN	3 CREDITS	1 COIN	1 CREDIT
SETTING #4	1 COIN	4 CREDITS	1 COIN	1 CREDIT
SETTING #5	1 COIN	5 CREDITS	1 COIN	1 CREDIT
SETTING #6	1 COIN	2 CREDITS	1 COIN	2 CREDITS
SETTING #7	1 COIN	5 CREDITS	1 COIN	2 CREDITS
SETTING #8	1 COIN	3 CREDITS	1 COIN	3 CREDITS
SETTING #9	1 COIN	4 CREDITS	1 COIN	4 CREDITS
SETTING #10	1 COIN	5 CREDITS	1 COIN	5 CREDITS
SETTING #11	1 COIN	6 CREDITS	1 COIN	6 CREDITS
SETTING #12	2 COINS	1 CREDIT	2 COINS	1 CREDIT
SETTING #13	1 COIN	1 CREDIT	2 COINS	1 CREDIT
SETTING #14	1 COIN	2 CREDITS	2 COINS	1 CREDIT
SETTING #15	1 COIN	1 CREDIT	1 COIN	1 CREDIT
	2 COINS	3 CREDITS	2 COINS	3 CREDITS
SETTING #16	1 COIN	3 CREDITS	1 COIN	1 CREDIT
			2 COINS	3 CREDITS
SETTING #17	3 COINS	1 CREDIT	3 COINS	1 CREDIT
SETTING #18	4 COINS	1 CREDIT	4 COINS	1 CREDIT
SETTING #19	1 COIN	1 CREDIT	1 COIN	1 CREDIT
	2 COINS	2 CREDITS	2 COINS	2 CREDITS
	3 COINS	3 CREDITS	3 COINS	3 CREDITS
	4 COINS	5 CREDITS	4 COINS	5 CREDITS
SETTING #20	1 COIN	5 CREDITS	1 COIN	1 CREDIT
			2 COINS	2 CREDITS
			3 COINS	3 CREDITS
			4 COINS	5 CREDITS
SETTING #21	5 COINS	1 CREDIT	5 COINS	1 CREDIT
SETTING #22	1 COIN	2 CREDITS	3 COINS	1 CREDIT
			5 COINS	2 CREDITS
SETTING #23	2 COINS	1 CREDIT	2 COINS	1 CREDIT
	4 COINS	2 CREDITS	4 COINS	2 CREDITS
	5 COINS	3 CREDITS	5 COINS	3 CREDITS
SETTING #24	1 COIN	3 CREDITS	2 COINS	1 CREDIT
			4 COINS	2 CREDITS
			5 COINS	3 CREDITS
SETTING #25	1 COIN	1 CREDIT	1 COIN	1 CREDIT
	2 COINS	2 CREDITS	2 COINS	2 CREDITS
	3 COINS	3 CREDITS	3 COINS	3 CREDITS
	4 COINS	4 CREDITS	4 COINS	4 CREDITS
	5 COINS	6 CREDITS	5 COINS	6 CREDITS
SETTING #26	1 COIN	6 CREDITS	1 COIN	1 CREDIT
			2 COINS	2 CREDITS
			3 COINS	3 CREDITS
			4 COINS	4 CREDITS
			5 COINS	6 CREDITS
SETTING #27	FREE PLAY		FREE PLAY	

Table 2: COIN/CREDIT SETTING (COIN CHUTE INDIVIDUAL TYPE)

NAME OF SETTING	EACH SEAT'S COIN CHUTE	NAME OF SETTING	EACH SEAT'S COIN CHUTE
SETTING #1	1 COIN 1 CREDIT	SETTING #21	5 COINS 1 CREDIT
SETTING #2	1 COIN 2 CREDITS	SETTING #23	2 COINS 1 CREDIT
SETTING #3	1 COIN 3 CREDITS		4 COINS 2 CREDITS
SETTING #4	1 COIN 4 CREDITS		5 COINS 3 CREDITS
SETTING #5	1 COIN 5 CREDITS	SETTING #25	1 COIN 1 CREDIT
SETTING #11	1 COIN 6 CREDITS		2 COINS 2 CREDITS
SETTING #12	2 COINS 1 CREDIT		3 COINS 3 CREDITS
SETTING #15	1 COIN 1 CREDIT		4 COINS 4 CREDITS
	2 COINS 3 CREDITS		5 COINS 6 CREDITS
SETTING #17	3 COINS 1 CREDIT	SETTING #27	FREE PLAY
SETTING #18	4 COINS 1 CREDIT		
SETTING #19	1 COIN 1 CREDIT		
	2 COINS 2 CREDITS		
	3 COINS 3 CREDITS		
	4 COINS 5 CREDITS		

Table 3: MANUAL SETTING

COIN TO CREDIT	1 COIN 1 CREDIT
	2 COINS 1 CREDIT
	3 COINS 1 CREDIT
	4 COINS 1 CREDIT
	5 COINS 1 CREDIT
	6 COINS 1 CREDIT
	7 COINS 1 CREDIT
	8 COINS 1 CREDIT
	9 COINS 1 CREDIT
BONUS ADDER	NO BONUS ADDER
	2 COINS GIVE 1 EXTRA COIN
	3 COINS GIVE 1 EXTRA COIN
	4 COINS GIVE 1 EXTRA COIN
	5 COINS GIVE 1 EXTRA COIN
	6 COINS GIVE 1 EXTRA COIN
	7 COINS GIVE 1 EXTRA COIN
	8 COINS GIVE 1 EXTRA COIN
	9 COINS GIVE 1 EXTRA COIN
COIN CHUTE (# 1 / # 2) MULTIPLIER	1 COIN COUNTS AS 1 COIN
	1 COIN COUNTS AS 2 COINS
	1 COIN COUNTS AS 3 COINS
	1 COIN COUNTS AS 4 COINS
	1 COIN COUNTS AS 5 COINS
	1 COIN COUNTS AS 6 COINS
	1 COIN COUNTS AS 7 COINS
	1 COIN COUNTS AS 8 COINS
	1 COIN COUNTS AS 9 COINS

(G) SEQUENCE SETTING

Number of credits required for starting game, etc. can be set.

Function varies depending on the specific games. To find out what kind of functions are allotted to each sequence, or what is the initial value for each sequence, refer to the Instruction Manual of the game connected. Each sequence can be set between 1 ~ 5 credit(s).

```
COIN ASSIGNMENTS
SEQUENCE SETTING

SEQUENCE 1  1 CREDIT(S)
SEQUENCE 2  1 CREDIT(S)
SEQUENCE 3  1 CREDIT(S)
SEQUENCE 4  1 CREDIT(S)
SEQUENCE 5  1 CREDIT(S)
SEQUENCE 6  1 CREDIT(S)
SEQUENCE 7  1 CREDIT(S)
SEQUENCE 8  1 CREDIT(S)
-> EXIT
[WILD RIDERS XXXXXXXXXXXX]
DESCRIPTION OF SEQUENCE
1 CREDIT TO START
2 NO USE
3 NO USE
4 NO USE
5 NO USE
6 NO USE
7 NO USE
8 NO USE

SELECT WITH SERVICE BUTTON
AND
PRESS TEST BUTTON
```

In cases of video games such as WILD RIDERS. :

SEQUENCE 1 : Number of credits required for game start (initial value=1)

SEQUENCE 2 ~ 8 : NOT USED.

G. BOOKKEEPING

- BOOKKEEPING 1/2

This allows such data as operating time/No. of coins inserted/ No. of credits to be checked.

BOOKKEEPING 1/2	
TOTAL TIME	
0D 00H 00M 00S	
CREDIT	0
COIN 1	0
COIN 2	0
COIN 3	0
COIN 4	0
TOTAL COIN	0
COIN CREDIT	0
SERVICE CREDIT	0
TOTAL CREDIT	0
PRESS TEST BUTTON TO CONTINUE	

Press the TEST button to proceed to BOOKKEEPING 2/2.

- BOOKKEEPING 2/2

Each sequence displays the frequency of functioning.

BOOKKEEPING 2/2	
P1 SEQ 1	0
P1 SEQ 2	0
P1 SEQ 3	0
P1 SEQ 4	0
P1 SEQ 5	0
P1 SEQ 6	0
P1 SEQ 7	0
P1 SEQ 8	0
PRESS TEST BUTTON TO EXIT	

In cases of video games such as WILD RIDERS. :

P1 SEQ 1 : Play frequency of Player 1

P1 SEQ 2 ~ 8 : NOT USED.

H. BACKUP DATA CLEAR

Clears the contents of BOOKKEEPING.

BACKUP DATA CLEAR

YES(CLEAR)
-> NO(CANCEL)

SELECT WITH SERVICE BUTTON
AND PRESS TEST BUTTON

When clearing, bring the arrow to YES by using the SERVICE button and press the TEST button. Bring the arrow to NO and press the TEST button to have the menu mode return without clearing the data. COMPLETED is displayed when clearing is completed. Press the TEST button to return to the menu mode.

I. CLOCK SETTING

Set YEAR, MONTH, DAY, HOUR, and MINUTE for NAOMI 2 Main BD.

CLOCK SETTING

1998 12/02 14:30 33 WED

YEAR
MONTH
DAY
HOUR
MINUTE
-> EXIT

SELECT WITH SERVICE BUTTON
AND PRESS TEST BUTTON

Select the desired item with the SERVICE button and press the TEST button to increase the value. Upon finishing the SETTING, bring the arrow to EXIT and press the TEST button to return to the menu mode.

J. ROM BOARD TEST

In this test, on-ROM-BD ROM check is executed.
If GOOD is displayed below RESULT, it is satisfactory.
BYTE and WORD refers to the check sum of each unit.

```
GAME ROM TEST
[XXXXXXXXXXXXXXXX]

NO. TYPE RESULT BYTE WORD
IC22 16M ---- 0123 4567
IC1 64M GOOD 0123 4567
IC2 64M GOOD 0123 4567
IC3 64M GOOD 0123 4567
IC4 64M GOOD 0123 4567
IC5 64M GOOD 0123 4567
IC6 64M GOOD 0123 4567
IC7 64M GOOD 0123 4567
IC8 64M GOOD 0123 4567
IC9 64M GOOD 0123 4567
IC10 64M GOOD 0123 4567
      :
IC20 64M GOOD 0123 4567

PRESS TEST BUTTON TO EXIT
```

Program ROMs (IC22) do not display GOOD or BAD.
Press the TEST button to return to the menu mode.

K. GAME TEST MODE

Enters the TEST mode of the game connected. The TEST mode includes INPUT test, GAME ASSIGNMENTS such as game difficulty and others, BOOKKEEPING, etc. Depending on specific games, necessary items are added and unnecessary items removed. As such, the contents thereof may be changed.

9 - 3 GAME TEST MODE

A. SETTING THE CARD



- Be sure to use dedicated cards available for this product (i.e., 601-11051). Use of one other than such dedicated cards may cause a malfunction or failure of the machine.
- Be sure to set the specified number of cards in the specified orientation by using the specified procedure. Wrong setting of the cards may cause the machine to fail.
- This machine allows you to set up to 100 cards at a time. You must not set over 100 cards at a time. If you do so, a trouble such as card jamming may occur.
- Set virgin cards taken out from a container that was unpacked immediately before use. Use of any deformed or deteriorated card may cause trouble.
- Do not include a corrugated, bent, or used card in the card deck.

The card reader/writer is located on the top of the coin chute tower. Place the cards on the card reader/writer.

- Unlock and open the cover to find the card reader/writer. The dispenser on which you should place the cards is located at the rear of the reader/writer.
- From the card reader/writer, take out the dispenser upward in a straight line.
- Remove the cover from the back of the dispenser.
- Place the cards into the dispenser according to the instructions on the sticker annexed to the dispenser. There is no print face on a card of the Club Kart. Determine the card in reference to the inserting direction mark located at corners of the cards. Do not confuse the top/bottom or direction.
- Reinstall the cover to the dispenser.
- Insert the dispenser into the card reader/writer. The dispenser can be inserted only in the predetermined orientation.
- Close and lock the cover.

B. TURNING ON THE POWER

Turn on the AC unit's main switch to supply power to the unit. Once power is turned on, the fluorescent lamp in the bill board lights up. The Start System Screen displays after a lapse of several seconds. It is followed by the screen that indicates that the network is currently being checked if the communication mode has been set. If there is a bad or improper communication connection, each screen will not proceed to the next, remaining on the currently network-checked screen. If this occurs, resolve the error according to the instructions in this document.

If the communication mode has not been set or the communication check ends normally, the Motor Check Screen returns. While the Motor Check Screen is on-screen, the steering wheel can move either clockwise or counterclockwise. If you touch the wheel, the motor check is hindered and the game will not operate normally. So, you must not touch it at this time. Failures are displayed, if found. Resolve the errors according to the instructions in this document. Pressing the Start button while a failure is on-screen allows you to go to the next screen and start the game without reaction.

Next the Check Card Reader/Writer Screen displays. If cleaning is required or a failure is found, this is indicated on the screen. In this case, resolve the error according to the instructions in this document.

Once all the above steps have been completed, the Advertise Screen displays and voices are output through the left and right loudspeakers, unless you have set the machine so that no voices are output during the Advertise mode.

This product retains the number of credits and the ranking data even after the power is turned off. It does not retain data about the fractional number of coins (i.e., the number of coins not reaching one credit) or the bonus adder count.

C. CARD READER/WRITER



Take care if you work with the machine, without turning the power, in an attempt to return to the game. In the alive state, the machine may operate suddenly, causing your finger to be pinched or cut.

If a trouble such as card jamming occurs on the card reader/writer, you are notified of the trouble on the screen. You cannot proceed to a play unless you resolve the trouble at this time. First identify the trouble before you begin to take action.

When all cards are used up, you can no longer issue a new card, with the message "Now new Club Kart Card" cannot be created" on-screen, instead of a trouble indication.

To obtain the dedicated or cleaning cards, place an order to the contact point or the dealer from which you purchased the product. In the order form, write down the card name and the amount of cards.

With each of the following part numbers, you can purchase 200 dedicated and 30 cleaning cards.

Dedicated Card

Part number: 601-11051

Name: CARD PACKAGE CKT

Cleaning Card

Part number: 601-11050

Name: CLEANING KIT

1) Action in Operation

The game board of this product backs up the data only when the card reader/writer detects a trouble DURING OPERATION and the Error Screen displays. However, no written data is backed up in the following cases:

- An action deemed to be illegal was detected while the game or write was in operation.

If backed up data remains when the power is turned on, the Check Card Reader/Writer Screen will be replaced with the Save Data screen. The backed up data is cleared in the following cases:

- After an action was taken against a trouble, normal write ended.
- The backed up data was cleared in the Game Test Mode.
- Data save taking place at power-on time was canceled, and the succeeding game ended.

If the card reader/writer has not been set as being unused, you will be unable to select any game mode with use of cards while the game will be in progress.

Thus, for the card reader/writer, deal with the player, paying attention to the following points:

- When a trouble occurs during write operation, the retained data can be written for proceeding to the game by resolving the trouble without turning on the power. If you resolved the trouble with power off, write the data according to the instructions on the screen when you attempt to turn on the power.
- Even if the player request the system for use of cards when you have set the machine so that the card reader/writer is not used, the request is rejected because of the nature of the system.

2) Setting the Card



IMPORTANT!

- Be sure to use dedicated cards available for this product (i.e., 601-11051). Use of ones other than such dedicated cards may cause a malfunction or failure of the machine.
- Be sure to set the specified number of card in the specified orientation by using the specified procedure. Wrong setting of the cards may cause the machine to fail.
- This machine allows you to set up to 100 cards at a time. You must not set over 100 cards at a time. If you do so, a trouble such as card jamming may occur.
- Set virgin cards taken out from a container that was unpacked immediately before use. Use of any deformed or deteriorated card may cause a trouble.

The card reader/writer is located on the top of the coin chute tower. Place the cards on the card reader/writer. Card setting is enabled with power either on or off.

- Unlock and open the cover to find the card reader/writer.

The dispenser on which you should place the cards is located at the rear of the reader/writer.

- From the card reader/writer, take out the dispenser upward in a straight line.
- Remove the cover from the back of the dispenser.
- Place the cards into the dispenser according to the instructions on the sticker annexed to the dispenser. There is no print face on a card of the Club Kart. Determine the card in reference to the inserting direction mark located at corners of the cards. Do not confuse the top/bottom or direction.
- Reinstall the cover to the dispenser.
- Insert the dispenser into the card reader/writer. The dispenser can be inserted only in the predetermined orientation.
- Close and lock the cover.

3) Head Cleaning



IMPORTANT!

- If the head cleaning mode is entered while the power is on, use the head cleaning procedure according to the instructions on the screen. The head cleaning mode cannot be quitted for being ready for starting the game unless the head cleaning is completed.
- Be sure to use dedicated cleaning cards (i.e., 601-11050). Use of ones other than such dedicated cleaning cards may cause a malfunction or failure of the machine.
- Cleaning cards are disposable. They must not be used more than once.
- Use each cleaning card immediately after it is taken out from an unsealed package. Dried cards are ineffective for cleaning.
- Never use a cleaning procedure not described in this document. Use of it may cause a malfunction or failure of the machine.

This product memorizes the count you use the card reader/writer. When the power is turned off and on after the count of use exceeds 100, the head cleaning mode is entered while the Check Card Reader/Writer Screen is on-screen after you turn on the power. At this time, using a dedicated cleaning card, use the cleaning card procedure according to the instructions on the screen. The head cleaning mode cannot be quitted for being ready for starting the game unless the head cleaning is completed. You can use the Test Mode to perform the head cleaning mechanism assembly. For details, see the “Test Mode” section in this document.

Start the cleaning clears the count of use above.

- Insert the cleaning card into the slot according to the instructions on the screen. The card is retracted automatically.
- A screen displays that shows that cleaning is in progress.
- Once the cleaning is completed, the cleaning card is ejected from the slot. Take out the cleaning card.

Cleaning Card Reader/Writer Screen

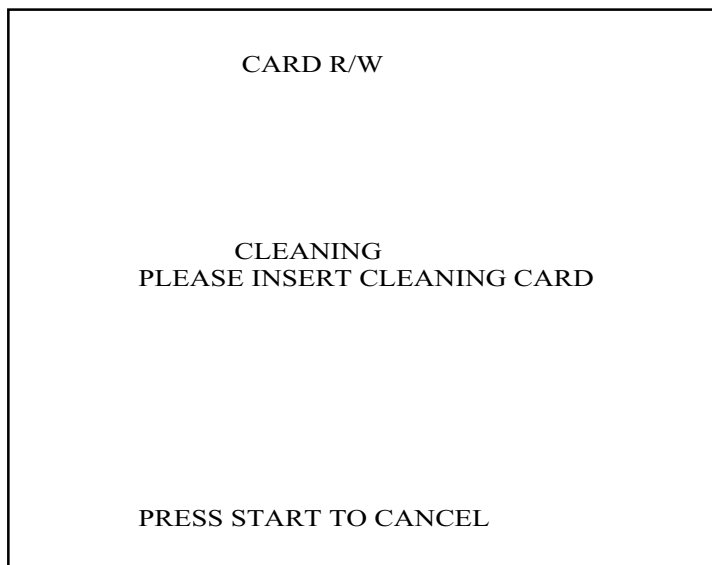

Insert the cleaning card into the slot.
Now cleaning. Wait for a minute.
Cleaning is complete. Take out the card.
You cannot proceed to the next step until you take it out.

4) Takin Action Against Card Jamming

If card jamming occurs, the error is shown on the screen. Use the procedure to take action against the trouble:

- Unlock and open the cover.
- Unlock the hatch by drawing the green shaft attached to the top cover on the card reader/writer. While drawing the shaft, open the cover up.
- Remove the card jammed in the card reader/writer.
- While drawing the shaft, close the cover. With the top cover closed, release the green shaft. Check that the top cover has been locked securely.

Forcible Cleaning

This product memorizes the count you use the card reader/writer. When the power is turned off and on after the count of use exceeds 100, the head cleaning mode is entered while the Check Card Reader/Writer Screen is on-screen after you turn on the power. The head cleaning mode cannot be quitted for being ready for starting the game unless the head cleaning is completed. When the card reader/writer is subjected to head cleaning, the count of use is cleared and the the mode ends.

At this time, using a dedicated cleaning card, use the cleaning card procedure according to the instructions on the screen.

The count of use above is cleared also when the Test Mode is used for head cleaning.

Cleaning Card Reader/Writer Screen

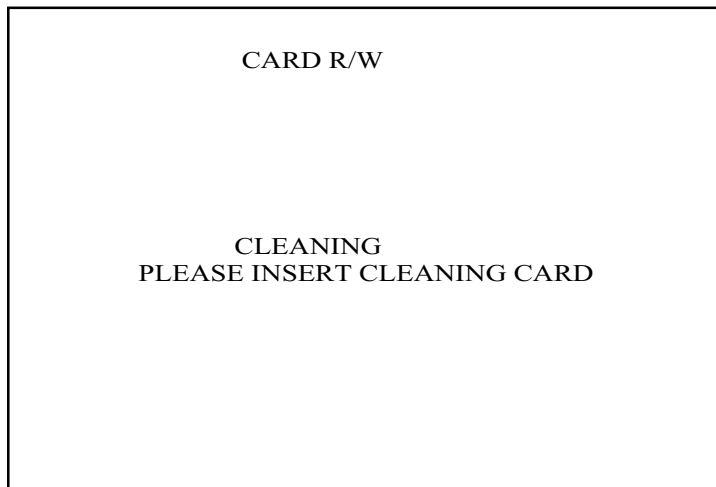

- Insert the cleaning card into the slot. The card is retracted automatically.
- Now cleaning. Wait for a minute.
- Cleaning is complete. Take out the card. You cannot proceed to the next step until you take it out.

D. REWRITING DATA ONTO THE CARD

The game board of this product backs up the data only when the card reader/writer detects a trouble DURING OPERATION and the Error Screen displays. However, no written data is backed up in the following case:

- An action deemed to be illegal was detected while the game or write was in operation.

If backed up data remains when the power is turned on the Check Card Reader/Writer Screen will be replaced with the Save Data screen. Once written onto the cord, the backed up data is cleared before the mode ends.

Write the data onto the desired card according to the instructions on the screen.

You can use the Start button to cancel the write.

The backed up data is cleared in the following cases:

- Normal write ended.
- The backed up data was cleared in the Game Test Mode.
- Data save taking place at power-on time was canceled, and the succeeding game ended.

Rewrite Data Onto Card Screen

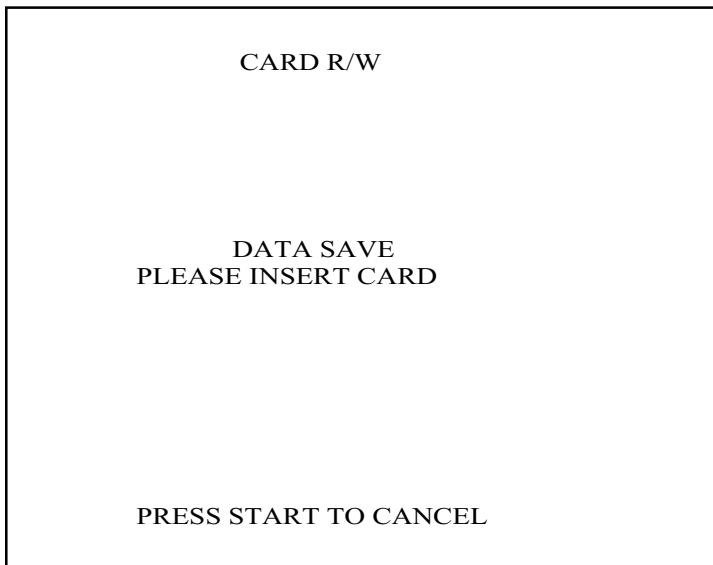

- Insert the cleaning card into the slot. The card is retracted automatically.
- Now writing data. Wait for a minute.
- Data write is complete. Take out the card. You cannot proceed to the next step until you take it out.

E. CARD LOW LEVEL ADJUSTMENT

- Your game is equipped with a card “Low Level” system. It consists of a screw that moves with the magazine as cards are dispensed. When the screw gets low enough, the beam is interrupted and the LED is illuminated.

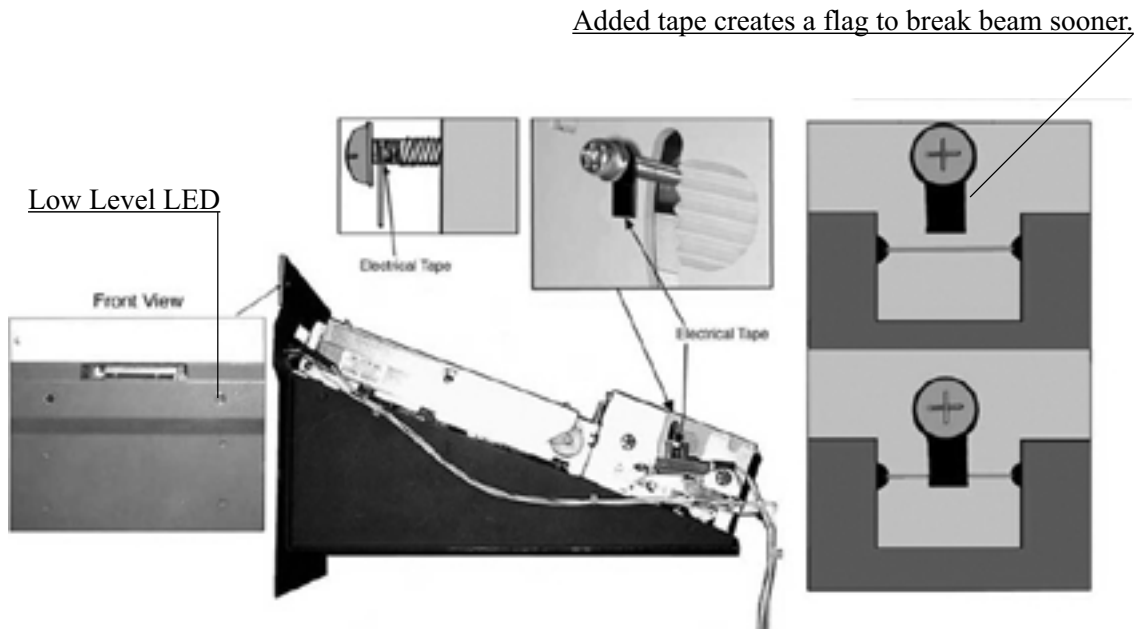

- Current configuration provides notification at approximately 10 card (+/- 2). If you feel you need sooner notification, see the diagram for suggested adjustment method.

E. TROUBLESHOOTING

Card Reader/Writer Trouble

When a card reader/writer failure is detected while the game is in progress, the error type is shown on the screen. Take the appropriate error according to the actions listed below.

The game board of this product backs up the data only when the card reader/writer detects a trouble DURING OPERATION and the Error Screen displays. However, no written data is backed up in the following case:

- An action deemed to be illegal was detected while the game or write was in operation.

If backed up data remains when the power is turned on, the Check Card Reader/Writer Screen will be replaced with the Save Data screen. The backed up data is cleared in the following cases:

- After an action was taken against a trouble, normal write ended.
- The backed up data was cleared in the Game Test Mode.
- Data save taking place at power-on time was canceled, and the succeeding game ended.

Error • Error condition • Action

“CONNECTION ERROR”

Reader/ Writer Communication Error - Check the connection cables and then turn on the power again.

“MECHANIC ERROR1”

DC Motor/Encoder Error - Check the connection cables and then turn on the power again. (Note 1)

“MECHANIC ERROR2”

Thermal Head Elevation Error - Check the connection cables and then turn on the power again.
(Note 1)

“CARD STUFFED”

Card Jamming - Remove the card jam. (Note 2)

“MECHANIC ERROR3”

Abnormal Temperature of Thermal Head - Check the connection cables and then turn on the power again. (Note 1)

“CARD EMPTY”

Hopper Card Not Found - Supply card to the hopper. (Note 2)

“DRAW CARD ERROR”

Error in Taking Out from the Hopper - Remove the card jame and check the hopper. (Note 2)

“CAN'T SAVE”

No Data Can Be Written onto the Card. (Note 3)

“UNKNOWN ERROR”

Error Other Than Above - Check the connection cables and then turn on the power again.

“SCIF ERROR”

SCIF Error - Check the connection cables.

Note 1: If this error reappears frequently, the card reader/writer body may be faulty.

Note 2: After the action has been taken, press the Start button before you follow the instructions on the error screen. Now you can return to the game.

Note 3: If the same error repeats again and again, clean the card reader/writer. If no data can still be written, the card reader/writer body may be faulty.

Without entering the Test Mode, turn on the power, again, to the cabinet if the following is included in the “Action” column in the above table: “turn on the power again.”

If the error is not included in the “Error” column in the above table, merely turn on the power again.

If no improvements result from the appropriate action listed in this document, contact one of the contact points listed in this document or the dealer from which you purchased the product.

Reaction Motor Trouble

When a failure is detected on the Check Motor Screen, which appears when the power is turned on. Use the following procedure to take action:

Error Display 1

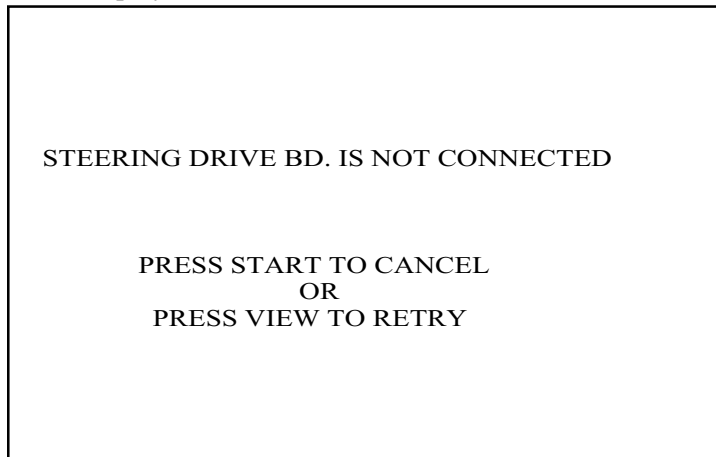

This is an error in communication between NAOMI 2 and the motor driver. Check the wiring. Pressing the Start button starts the game without steering-wheel reaction. Pressing the View button reinitiates the machine.

Error Display 2

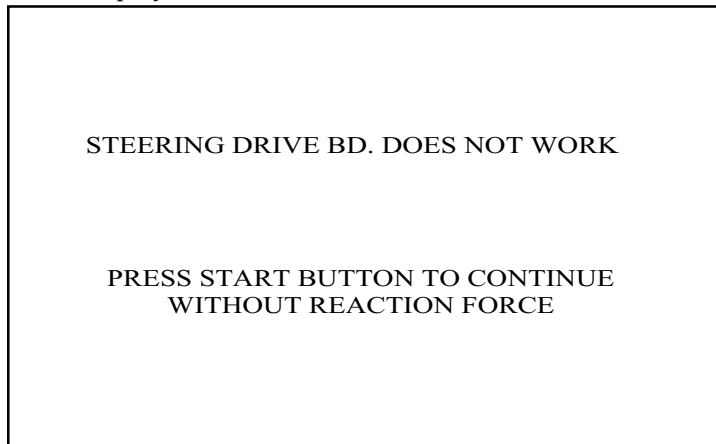

This is an error that occurs when the motor could not be initialized properly. Check the wiring between the driver motors.

Pressing the start button starts the game without steering-wheel reaction.

When a failure is detected while the game is in progress, it continues to operate until it ends.

After the game ends, you are brought to the same screen as Check Motor that appeared at power-on time. If a failure is detected at this time, Error Display 2, above, appears. Take action against it. Usually, the encoder annexed to the motor is used for detection of the steering wheel; however, it will be unavailable if a failure is detected on the motor. The handle mechanism is provided with a spare volume for this reason. When the handle center is set with Set Volume Control Screen in the Test Mode, volume center setting, as well as encoder setting, takes place. However, when you make the machine operate without reaction because of a motor failure, center the volume control again by way of precaution.

F. GAME MENU



IMPORTANT!

- The new settings will not take effect until the Game Test Mode is exited. When you make change to the settings, exit the Game Test Mode by proper operation.
- You must not attempt to demonstrate this game (for the selling purpose) with any other than those specified in this document. Use of such settings may cause mal-functions or bad operation on the machine.

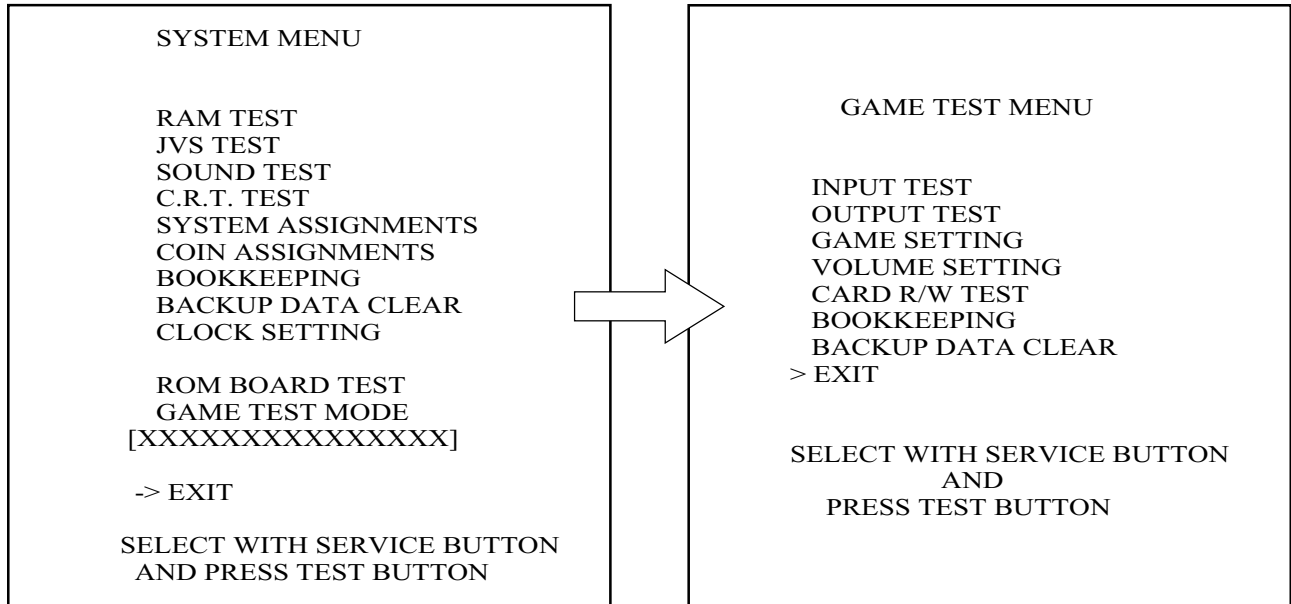

Pressing the SERVICE button moves the arrow on the screen. Move the arrow to select the item you want to run. Pressing the TEST button runs the currently selected item. The screen changes to the one for that item, and you can change or adjust the settings. Select EXIT and press the TEST button to return to the System Test Menu Screen.

G. INPUT TEST



CAUTION!

- By selecting INPUT TEST on the Menu Screen and pressing the Test button, the steering wheel is centered automatically as done when the machine is started. To protect persons from accidents make sure that nobody is in contact with the steering wheel before pressing the TEST button.
- To prevent accidents, breakage of parts, and malfunctions, do not touch the steering wheel until centering of the steering wheel is completed.

INPUT TEST tests the input devices. Using this screen, check the input devices periodically.

Operate each input device. If the display at the right of the appropriate device changes from OFF to ON, it is diagnosed as being normal.

Check that each of the indications at the right of STEERING, ACCEL, and BRAKE change smoothly in response to operations of each of the input devices.

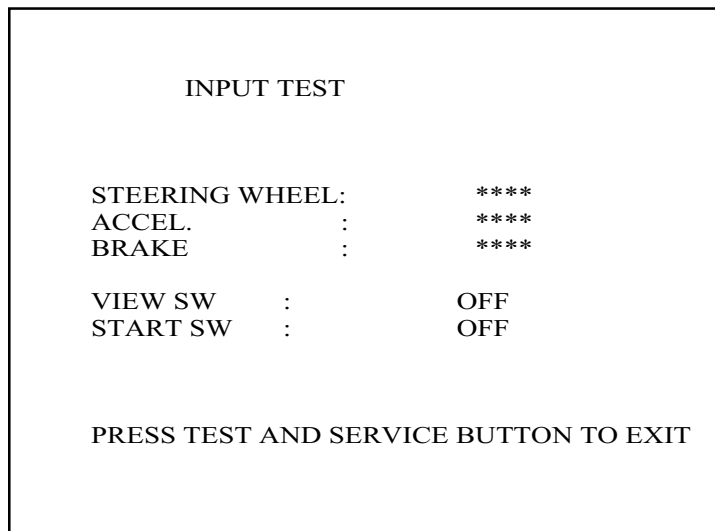

Pressing the TEST button returns you to the Game Test Menu Screen.

VOLUME CONTROL RECOMMENDED SETTINGS

- Steering wheel: Centered (when traveling in a straight line) 2000H
- Accelerator:
 - When the pedal is released 30H
 - When the pedal is pressed fully C0H
- Brake:
 - When the pedal is released 30H
 - When the pedal is pressed fully C0H

H. OUTPUT TEST

You can monitor the state of the lights. Use this screen to check the lights periodically.

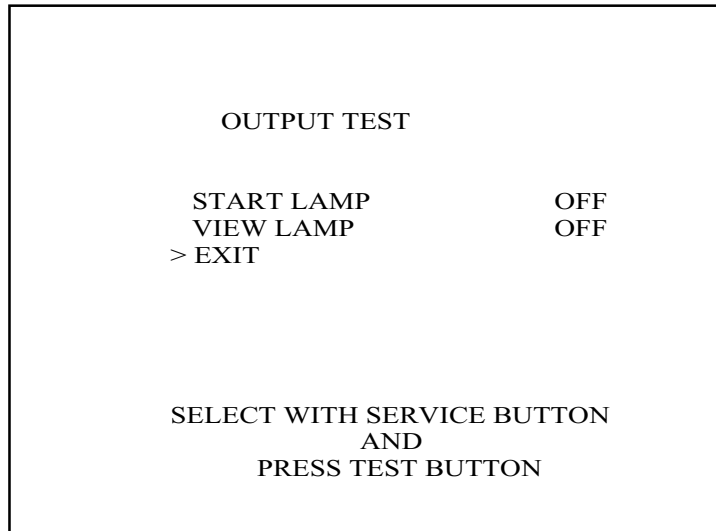

Pressing the SERVICE button moves the arrow. With the arrow aligned with the tested lamp item, press the TEST button.

If the lamp lights up when the indication at the right of each name is ON and goes out when it is OFF, this lamp and wiring connections are normal.

By selecting EXIT and pressing the TEST button, you return to the Game Test Menu Screen.

I. GAME SETTING

You can make the settings about cabinet operations such as the communicated mode or the reaction force of the steering wheel.

MAKING CHANGE TO THE SETTINGS

1. By pressing the SERVICE button, move the arrow (>) to the desired item to change.
2. Pressing the Test button changes the display at the right of the currently selected item. Change the item to the desired display.
3. Press the SERVICE button to select EXIT. Then press the TEST button. This returns you to the Game Test Menu Screen.

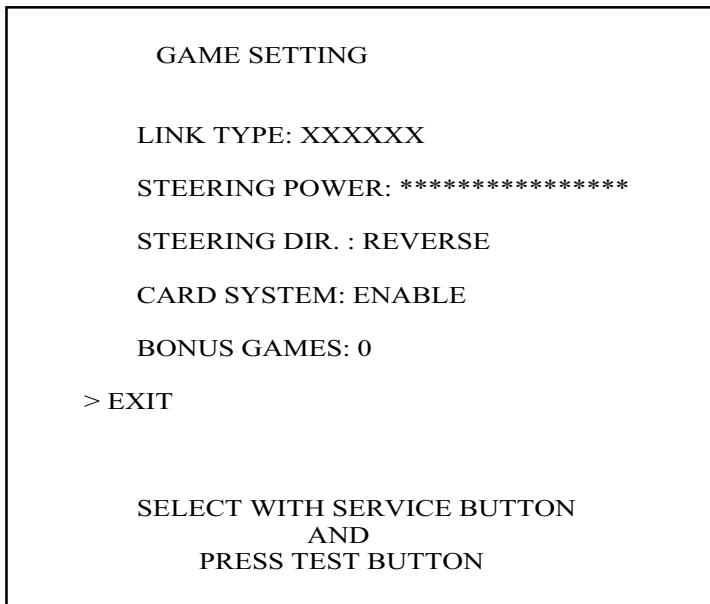

- **LINK TYPE:** Used for settings of communicated play. You have four options: MASTER, SLAVE, SATELLITE, and STAND-ALONE. If you want to enjoy the game alone, set to STAND-ALONE. Setting for communicated play, be sure to set MASTER for only one machine, or seat, and set SLAVE for all the remaining ones. SATELLITE is a setting for a relay monitor.
- **STEERING POWER:** Sets reaction for the steering wheel. Increase or decrease in the number of asterisks (*) is reflected to the reaction force. The more the asterisks, the reaction force the larger.
- **STEERING DIR.:** Sets steering reaction direction. Default for deluxe game is REVERSE.
- **CARD SYSTEM:** Activates card reader system.
- **BONUS GAMES:** Choose 0-3.

J. VOLUME SETTING



- By setting VOLUME SETTING on the Menu Screen and pressing the TEST button, the steering wheel is centered automatically as done when the machine is started. To protect persons from accidents, make sure that nobody is in contact with the steering wheel, before pressing the TEST button.
- To prevent accidents, breakage of parts, and malfunctions, do not touch the steering wheel until centering of the steering wheel is completed.



- No normal play is guaranteed unless all the input devices are set properly. Be sure to make the proper settings before you begin demonstration for the selling purpose.
- Once you have completed change to the settings, select EXT and press the TEST button. The new settings will not take effect until this mode is exited.

By setting the VOLUME SETTING on the Menu Screen and pressing the Test button, centering of the steering wheel is initiated automatically. After the centering is completed, you can use the screen below to make the steering wheel, accelerator, and brake settings.

If the operability of the steering wheel, accelerator, or brake is poor, use this screen to make the proper settings for the volume control.

VOLUME SETTING		
MIN	MID	MAX
[2000]	2000	
STEER: *-----*		
[2000]3000		C000
ACCEL: ---*-----*		
[8100]3000		C000
BRAKE: ---*-----*		
> EXIT		
SELECT WITH SERVICE BUTTON AND PRESS TEST BUTTON		

1. By moving the SERVICE button to move the arrow, select the input device for which you want to make settings.
2. For either the accelerator or brake, press START without pressing the pedal. Set the value resulting when you release it.
3. With the pedal pressed fully, press START to set the value resulting when you press it fully.
4. For the steering wheel, press START while supporting it along the straight line.
5. Select EXIT and press the TEST button.

The setting changes are not updated until you select EXIT. After you make change to the settings, be sure to select EXIT.

By selecting EXIT and pressing the TEST button, you return to the Game Test Menu Screen.

K. CARD R/W TEST



IMPORTANT!

Check operation of the card reader/writer (R/W) and clean it periodically.

This screen lets you check operation of the card reader/writer (R/W) or clean it.

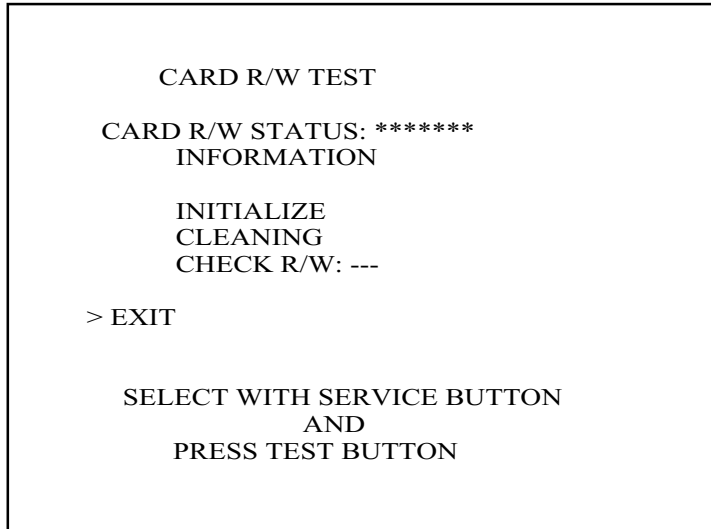

The arrow can move to the following items:

- INITIALIZE: Initialization
- CLEANING: Cleaning
- CHECK R/W: R/W Operation Check

Depending on the R/W running mode, one of the following is displayed in “*****” in “CARD R/W STATUS: *****” :

READY	Now waiting (Clear to Send Command)
INITIAL	Now initializing (Not Clear to Send Command)
CLEAN	Now cleaning (Not Clear to Send Command)
GET	Cards are being taken out from the hopper (Not Clear to Send Command)
SAVE	Sample data is saved onto the card (Not Clear to Send Command)
LOAD	Load card data and compares it with sample data (Not Clear to Send Command)
OUT	Eject cards (Not Clear to Send Command)
ERROR	Error (Clear to Initialize Command Only)

While a status with a note of “Not Clear to Send Command” in parentheses is on-screen, no operations are accepted. If such a status has occurred, wait until the operation in that status stops automatically and the display comes to READY.

Should you need to cancel the operation forcibly, turn off the power. If you cancel it forcibly, be sure to select and run INITIALIZE after turning on the power.

Occasionally, the “INFORMATION” field on the screen outputs one of the instructions below, although it usually contains nothing.

While cleaning is in progress, waiting in the ready mode for inserting a cleaning card:

----- PLEASE INSERT CLEANING CARD -----

After the operation check, waiting for the ready mode for ejecting the card:

----- PLEASE REMOVE CARD -----

When an error occurs, its type is displayed in the “INFORMATION” field:

CONNECTION ERROR	Connection Error
MECHANIC ERROR 1	DC Motor / Encoder Error
MECHANIC ERROR 2	Thermal Head Elevation Error
CARD STUFFED	Card Jamming
MECHANIC ERROR 3	Abnormal Temperature of Thermal Head
CARD EMPTY	Hopper Card Empty
DRAW CARD ERROR	Error in Taking Card from Hopper
CAN'T SAVE	Data cannot be written onto the card.
UNKNOWN ERROR	Unknown Error
SCIF ERROR	RC-232C Communication Error
NO ERROR	No Error

The “---” field in “CHECK R/W: ---” shows the result of the operation check.

---	Not Checked
OK	No Failure
NG	Failure

The operation check takes out each card from the hopper, and writes the sample data onto it. The check whether the read data matches the sample data. Then, the check ejects the card. When you draw out the card at this time, the entire process of the check is completed.

CHECKING R/W OPERATION

1. Select “CHECK R/W” and press the TEST button.

R/W operates automatically as follows:

2. Takes out the card from the hopper: GET is displayed.
3. Saves the sample data onto the card: SAVE is displayed.
4. Loads the data on the card for comparison with the sample data: LOAD is displayed.
5. Ejects the card: OUT is displayed.
6. Draws out the card. Now the entire process of the check is completed.

If execution of the operation check results in display of NG, check the error condition. If you can take action against the error, execute the operation check again after you take the proper action. If you cannot take action against the error, repeat the check several times. If the result of the check is still NG, clean the R/W.

If the subsequent execution of the operation check still results in NG, the R/W may be faulty.

If an error occurs, it is cleared by executing the INITIALIZE command. Note that when an error has occurred, the R/W only accepts this command (except EXIT).

CLEANING PROCEDURE

1. Select “CLEANING” and press the TEST button.

The following message appears to show that the R/W is ready for insertion of the cleaning card:

---PLEASE INSERT CLEANING CARD---

2. Insert the cleaning card into the R/W. On the screen, the status display is replaced with “CLEAN”, and cleaning begins.
3. Once cleaning ends after a lapse of a certain time, the R/W automatically ejects the card. The status display changes from “CLEAN” to “OUT.”

L. BOOKKEEPING

In four pages, this screen lists the data about the operation status up to now. Pressing the TEST button brings you to the next page of the screen. When you press the TEST button on Page 4/4 of the screen, you return to the Game Test Menu.

BOOKKEEPING 1/4				
NUMBER OF GAMES		0		
NUMBER OF CARD GAMES		0		
NUMBER OF NEW CARDS		0		
PLAY TIME	OD	OH	OM	OS
AVERAGE PLAY TIME		OH	OM	OS
LONGEST PLAY TIME		OH	OM	OS
SHORTEST PLAY TIME		OH	OM	OS
SELECT WITH SERVICE BUTTON AND PRESS TEST BUTTON				

- NUMBER OF GAMES: Number of games played.
- NUMBER OF CARD GAMES: Number of games played with cards.
- NUMBER OF NEW CARDS: Number of games played with cards.
- PLAY TIME: Time played.

BOOKKEEPING 2/4

TIME HISTOGRAM

OM00S - OM29S	0
OM30S - OM59S	0
1MOOS - 1M29S	0
1M30S - 1M59S	0
2M00S - 2M29S	0
2M30S - 2M59S	0
3MOOS - 3M29S	0
3M30S - 3M59S	0
4M00S - 4M29S	0
4M30S - 4M59S	0
OVER - 5MOOS	0

SELECT WITH SERVICE BUTTON
AND PRESS TEST BUTTON

TIME HISTOGRAM lists the number of plays for each of the play times.

BOOKKEEPING 3/4

PLAYS/CLASS

RENTAL BEGINNER	*
RENTAL NORMAL	*
CLASS NOVICE	*
CLASS B	*
CLASS A	*
CLASS S	*
CLASS SS	*
CLASS SSS	*

SELECT WITH SERVICE BUTTON
AND PRESS TEST BUTTON

PLAY/CLASS shows the count of plays by class.

BOOKKEEPING 4/4

PLAYS/COURSE

1-A	*
1-B	*
1-C	*
2-A	*
2-B	*
2-C	*
3-A	*
3-B	*
3-C	*
4-A	*
4-B	*
4-C	*

SELECT WITH SERVICE BUTTON
AND PRESS TEST BUTTON

The PLAYS/COURSE Screen lists the count of plays by course. Pressing the TEST button returns you to the Game Test Menu Screen.

M. BACKUP DATA CLEAR

BACKUP DATA CLEAR deletes data on the Bookkeeping Screen. To delete data about the coins/credits, run BACKUP DATA CLEAR in the System Test Mode. Clearing the data does not influence any data settings (except the data).

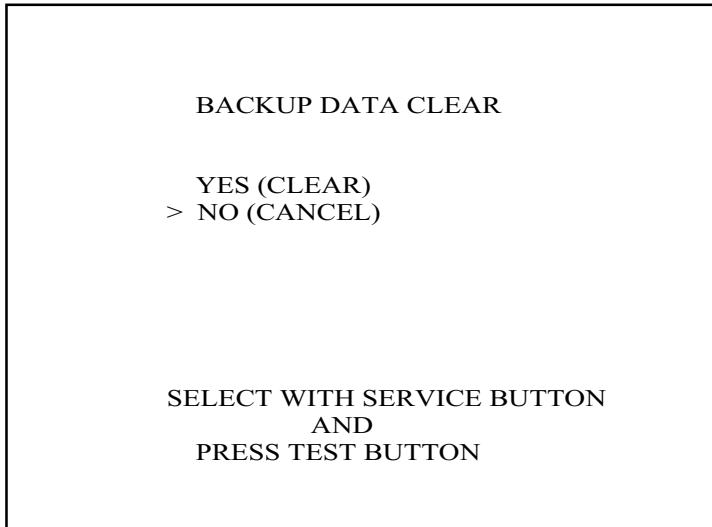

To delete the data, use the SERVICE button to align the arrow with CLEAR and press the TEST button. Once the data is deleted, this screen displays “COMPLETED.” Pressing the TEST button again returns you to the Menu Screen. If you choose not to delete the data, press the TEST button with the arrow aligned with NO. This returns you to the Menu Screen.

10. CONTROL PANEL (STEERING MOTOR UNIT)



- Before starting to work, ensure that the Power SW is OFF. Failure to observe this can cause electric shock or short circuit.
- Use care so as not to damage wirings. Damaged wiring can cause electric shock or short circuit.
- Do not touch undesignated places. Touching places not designated can cause electric shock or short circuit.
- This work should be performed by the Location's Maintenance Man or Serviceman. Performing work by non-technical personnel can cause electric shock hazard.
- Do not insert hand into the mechanism so as not to cause hand and fingers pinched in. Failure to observe this can cause a serious injury such as a fracture.
- When performing work such as parts replacement other than those specified in this manual, be sure to contact where you purchased the product from and confirm the work procedures and obtain precautions prior to performing work. Inappropriate parts replacement and/or installing with erroneous adjustment can cause an overload or the parts to come into contact, resulting in an electric shock, a short circuit, and a fire.
- Carefully handle the PTV on the PTV base because it is very unstable. If handled carelessly, it may fall down and eventually cause a serious personal injury.

10 - 1 ADJUSTING OR REPLACING THE V.R.

In cases the Steering operability is poor and the adjustment of VOLUME SETTING in the TEST mode is ineffective, the causes may be the Volume Gear's mesh failure and or Volume malfunctioning. By using the following procedure, adjust Volume gear mesh, or replace the Volume. In this product, when the Steering Wheel is moved fully left/right, if the Volume shaft is rotating within the movable range, the Volume is not feared to be damaged. Secure the Volume in the manner the Volume shaft is oriented as shown and the gears are appropriately engaged when the steering wheel is in the centering position allowing the car to go straight forward.

ADJUSTING THE VOLUME

Prepare a Phillips screwdriver and a wrench for M8 hexagonal nut.

- ① Turn off power.
- ② Referring to Chapter 6, uncouple the PTV and the main cabinet from each other. However, leave the wires connected.

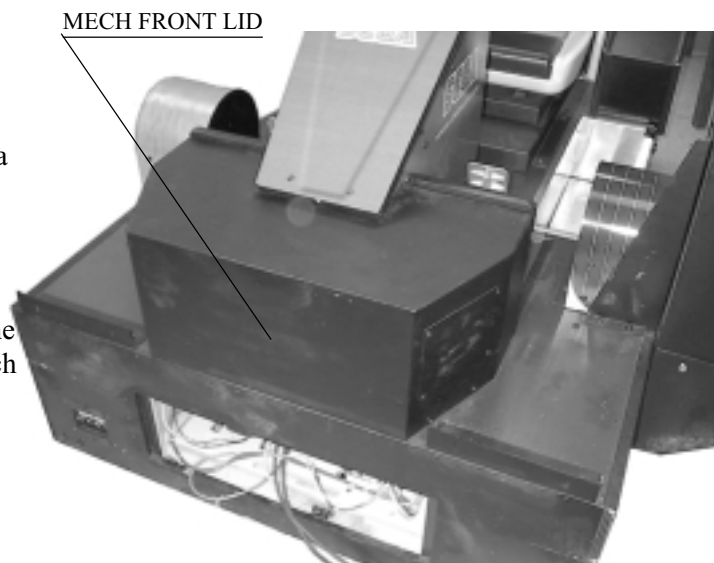

PHOTO 10. 1 a

- ③ The V.R. is on the VR BASE (a white, plastic made part). Loosen the 2 screws which secure the VR BASE and adjust the angle and appropriateness of gear mesh by moving the VR BASE.
- ④ Adjust to an appropriate mesh by securing the Steering Wheel in the direction allowing the car to advance straight forward and ensuring the "D" CUT FACE of the Volume shaft is oriented as shown.
- ⑤ Tighten the 2 screws to secure the VR BASE.

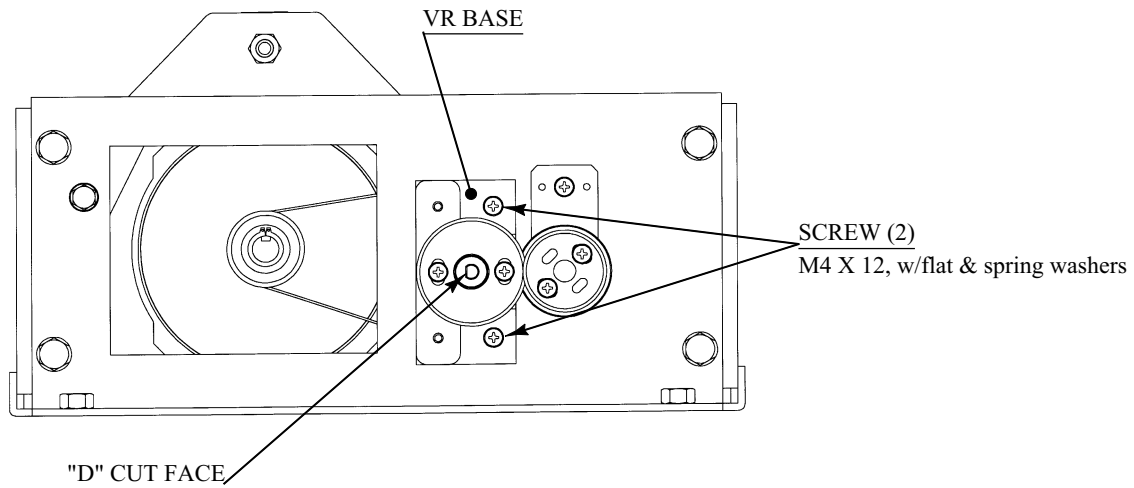
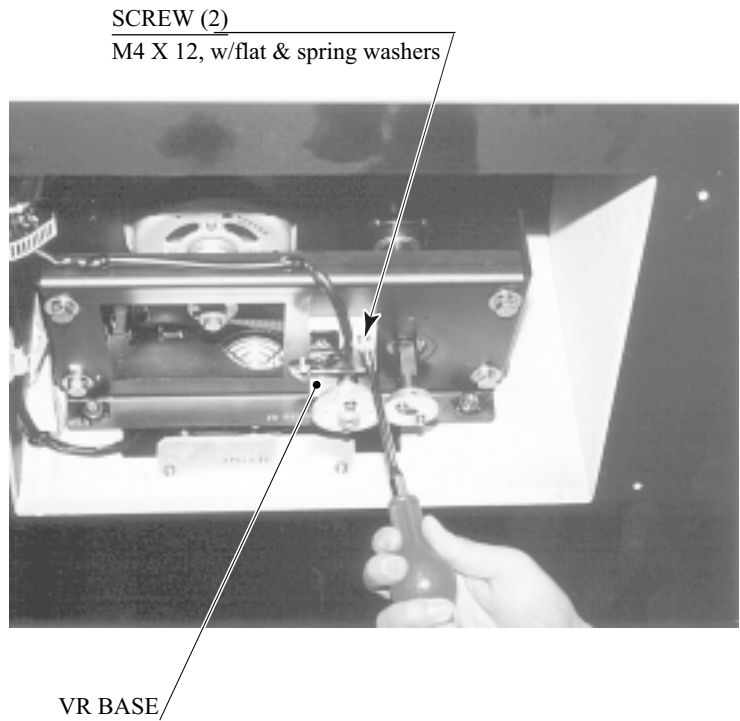

FIG. 10. 1 a

- ⑥ Turn on power.
- ⑦ Set the Center Value of the Volume in the TEST mode.
- ⑧ In the TEST mode, check to see if the Volume Value varies smoothly in accordance with the steering wheel operation.

REPLACING THE VOLUME

- ① Disconnect the connector from the Volume.
- ② Take out 2 screws to remove the Volume together with VR BASE from the HANDLE MECHA.



- ③ Take out 2 screws from the VR BASE reverse side to remove the Volume together with VR Bracket from the VR BASE.
- ④ Remove the Volume from VR Bracket and replace.

TRUSS SCREW (2)
M4 X 12

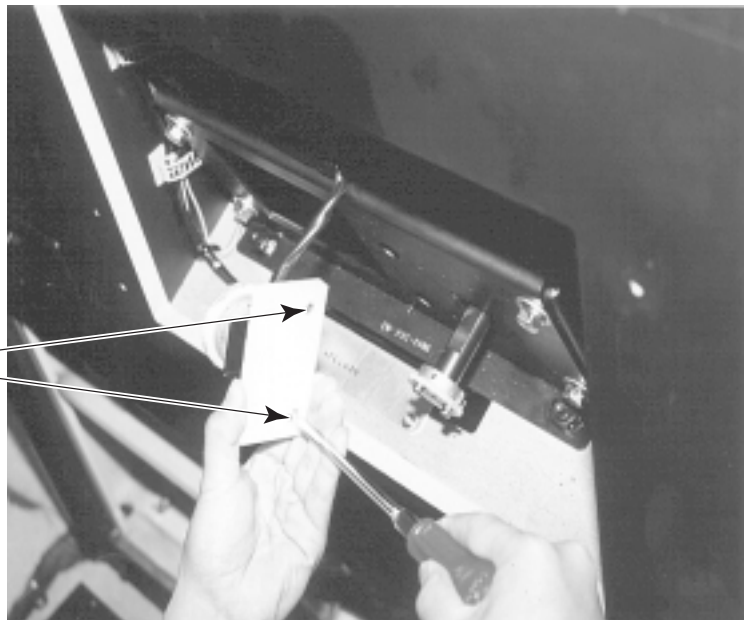

- ⑤ After replacing the Volume, engage the gears at the angular position shown and fix the VR Bracket.

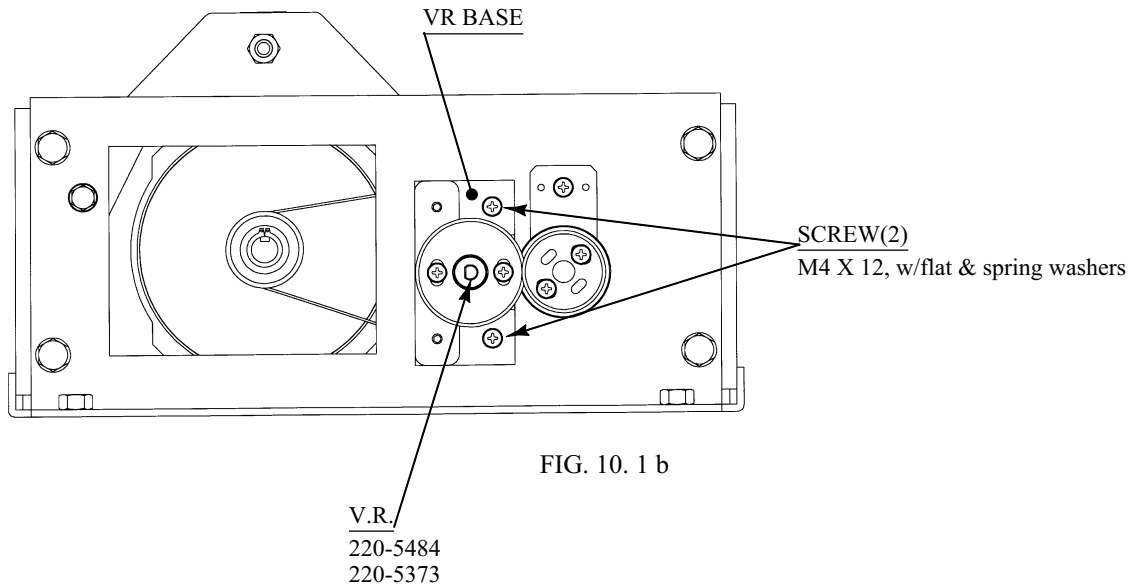

- ⑥ Turn on power.
- ⑦ Set the Center Value of the Volume in the TEST mode.
- ⑧ In the TEST mode, check to see if the Volume Value varies smoothly in accordance with the steering wheel operation.

10 - 2 GREASING



- Be sure to use the designated grease. Using undesignated grease can cause parts damage.
- Do not apply greasing to undesignated places. Failure to observe this can cause malfunctioning or quality deterioration of parts.

Apply greasing to gear mesh portions once every 3 months. Use GREASE MATE (SEGA PART NO. 090-0066).



PHOTO 10. 2

11. ACCELERATOR & BRAKE



- Before starting to work, ensure that the Power SW is OFF. Failure to observe this can cause electric shock or short circuit.
- Use care so as not to damage wirings. Damaged wiring can cause electric shock or short circuit.
- Do not touch undesignated places. Touching places not designated can cause electric shock or short circuit.
- This work should be performed by the Location's Maintenance Man or Serviceman. Performing work by non-technical personnel can cause electric shock hazard.
- When performing work such as parts replacement other than those specified in this manual, be sure to contact where you purchased the product from. Confirm the work procedures and obtain precautions from where you purchased the product from prior to performing work. Inappropriate parts replacement and/or installation with erroneous adjustment can cause an overload or the parts to come into contact, resulting in an electric shock, a short circuit, and a fire.

If Accel. and Brake operation is not satisfactory, adjustment of Volume installation position or Volume replacement is needed. Also, be sure to apply greasing to the gear mesh portion once every 3 months.

11 - 1 ADJUSTING AND REPLACING THE V.R.

The appropriate value for both ACCEL. Volume and Brake Volume is under 30H when released and over C0H when stepped on. Check Volume values in the TEST mode. Since work is performed inside the energized cabinet, be very careful so as not to touch undesignated places. Touching places not specified can cause electric shock or short circuit.

- ① Take out the 2 truss screws and remove the Front Cover from the Accel. & Brake Unit
- ② Loosen the screw which secure the Potentiobase, and adjust the Volume value by moving the Base. (FIG. 11. 1 b)
- ③ Secure the Potentiobase.
- ④ Perform Volume setting in the Volume setting mode.

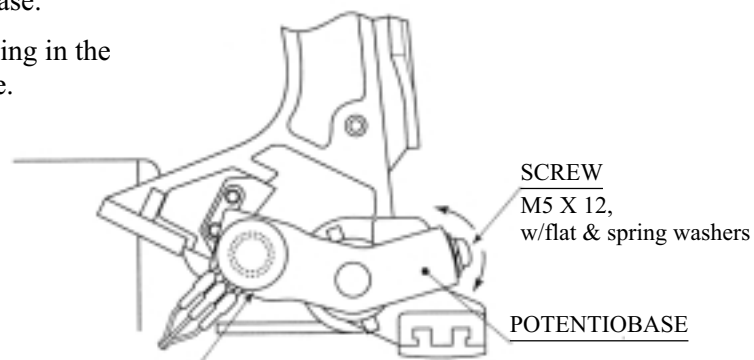

V.R.
220-5484
220-5373

FIG. 11. 1 b

REPLACING THE VOLUME

- ① Turn the power off.
- ② Take out the 2 screws and remove the Pedal cover (FIG. 11. 1 c).
- ③ Disconnect the connector of the Volume to be replaced.
- ④ Remove the screw which secures the Pedal base (FIG. 11. 1 b).
- ⑤ Remove the Pedal base together with the Volume as is attached. (FIG. 11. 1 c)
- ⑥ Remove the Base and Gear to replace the Volume.
- ⑦ Adjust the Volume as per the previous page after replacing.

FIG. 11. 1 c



11 - 2 GREASING



IMPORTANT

Be sure to use the designated grease. Using undesignated grease can cause parts damage.

Once every 3 months, apply greasing to the Spring and Gear mesh portion. For spray greasing, use GREASE MATE (PART No. 090-0066).

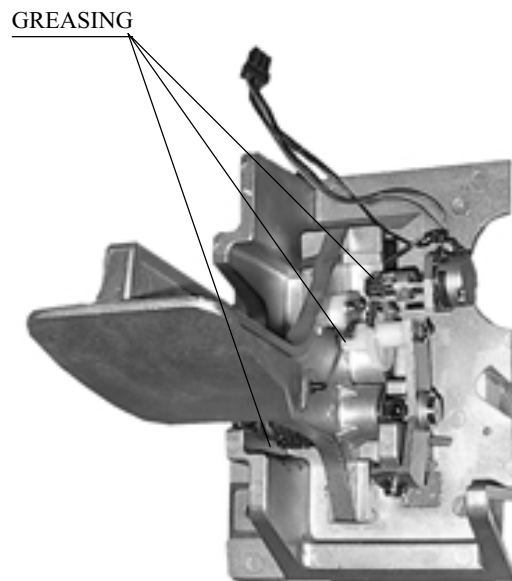

FIG. 11. 2

12. PROJECTOR



Since the Projector has been adjusted at the time of shipment, avoid making further adjustments without good reason.



The Projector is subject to color deviation due to Convergence deviation caused by the geomagnetism at the installation location and peripheral magnetic field. After the installation of machine, and before commencing operation, check for Convergence deviation and if deviated, make adjustments.

Projector adjustments are stored. Due to distortion or color deviation in the TEST mode, if an adjustment is necessary, use the Remote Control to make adjustments. There are two Projector Makers (Toshiba and Mitsubishi) and the adjustment method varies depending on the specific maker.

12 - 1 CLEANING THE SCREEN



Since the Projector screen is susceptible to damage, pay careful attention to its handling. When cleaning, refrain from using water or volatile chemicals.

When the screen surface becomes dirty with dust, etc., clean it by using a soft cloth such as gauze. When water, and volatile chemicals such as benzine, thinner, etc., spill on the screen surface, it may be subject to damage, therefore, do not use them. Also, since the surfaces are susceptible to damage, refrain from rubbing them with a hard material or using a duster.



FIG. 12. 1

SETTING THE INTERFACE



In this product, set to INPUT LEVEL: 0.7V and IMPEDANCE: 75Ω. Failure to observe this can cause CRT membrane to burn or Shutdown device to function resulting in power off.

The Projector's Connector Panel contains the Interface setting SW.

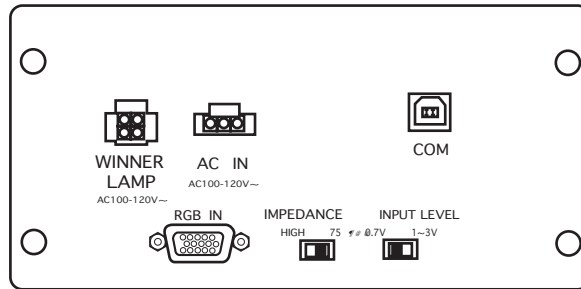

REMOTE CONTROL BUTTONS

When adjusting the Projector, direct the Remote Control's light emitting portion towards the Projector Screen.

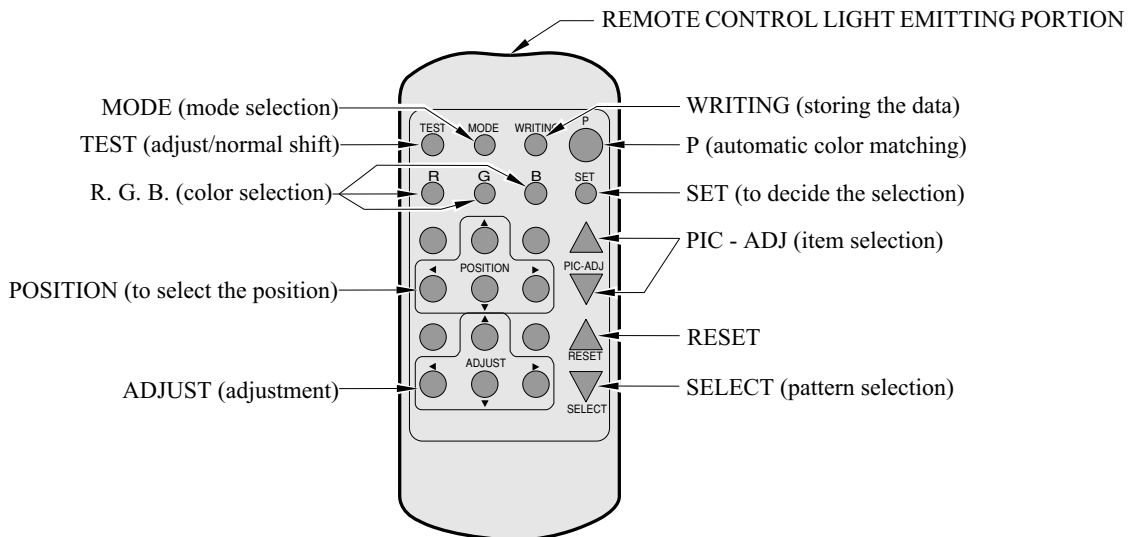

AUTOMATIC COLOR MATCHING

The Projector may be subject to color deviations affected by earth magnetism, the building steel frames, etc. When the Projector is initially installed or the Projector's installation position is changed, have the color matching performed automatically.

- ① Keep pressing the P button (red) for approximately 3 seconds to have the ensuing movements performed automatically.

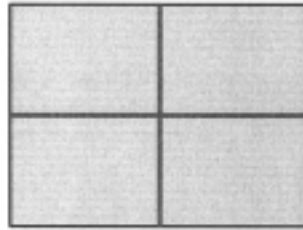
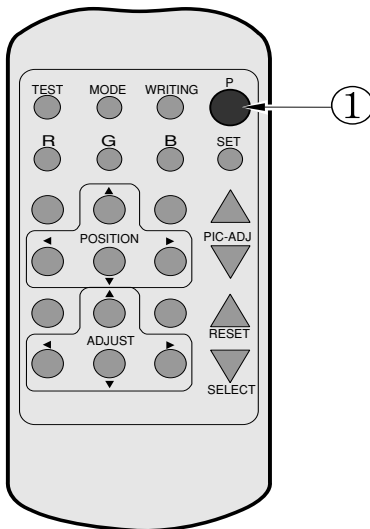

The Projector will shift to the color deviation correction mode from the game mode, with the green cross pattern appearing on the screen.

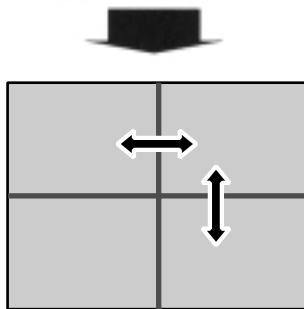

The cross pattern moves up/down and right/left to start the movement of searching the correct screen position and inclination.

When the green cross pattern movements are finished, similar detection is performed sequentially in order of red and then blue cross movements. After detecting by green, red and blue cross movements, the game mode returns with the color deviation status being corrected.

- Although very rarely, the TRY AGAIN error display in red may appear. At this time, press the P button (red) for approximately 3 seconds. Even after the above operation is repeated, if the error condition still exists, then the display shifts to PLEASE ADJ. In this case, the auto color matching function can not be used. Contact the place of contact herein stated or where the product was purchased from.
- If the automatic color matching indicates an error, color matching can manually be performed. Refer to CONVERGENCE ADJUSTMENT (manual color matching).

ADJUSTING THE ON-SCREEN CONTRAST

Although the on-screen picture quality has been adjusted at the time of shipment from the factory, the on-screen contrast can be readjusted if desired. When the Game Board is replaced, readjustment may be necessary. Changing the CONTRAST causes the light and shade of the on-screen images to be changed.

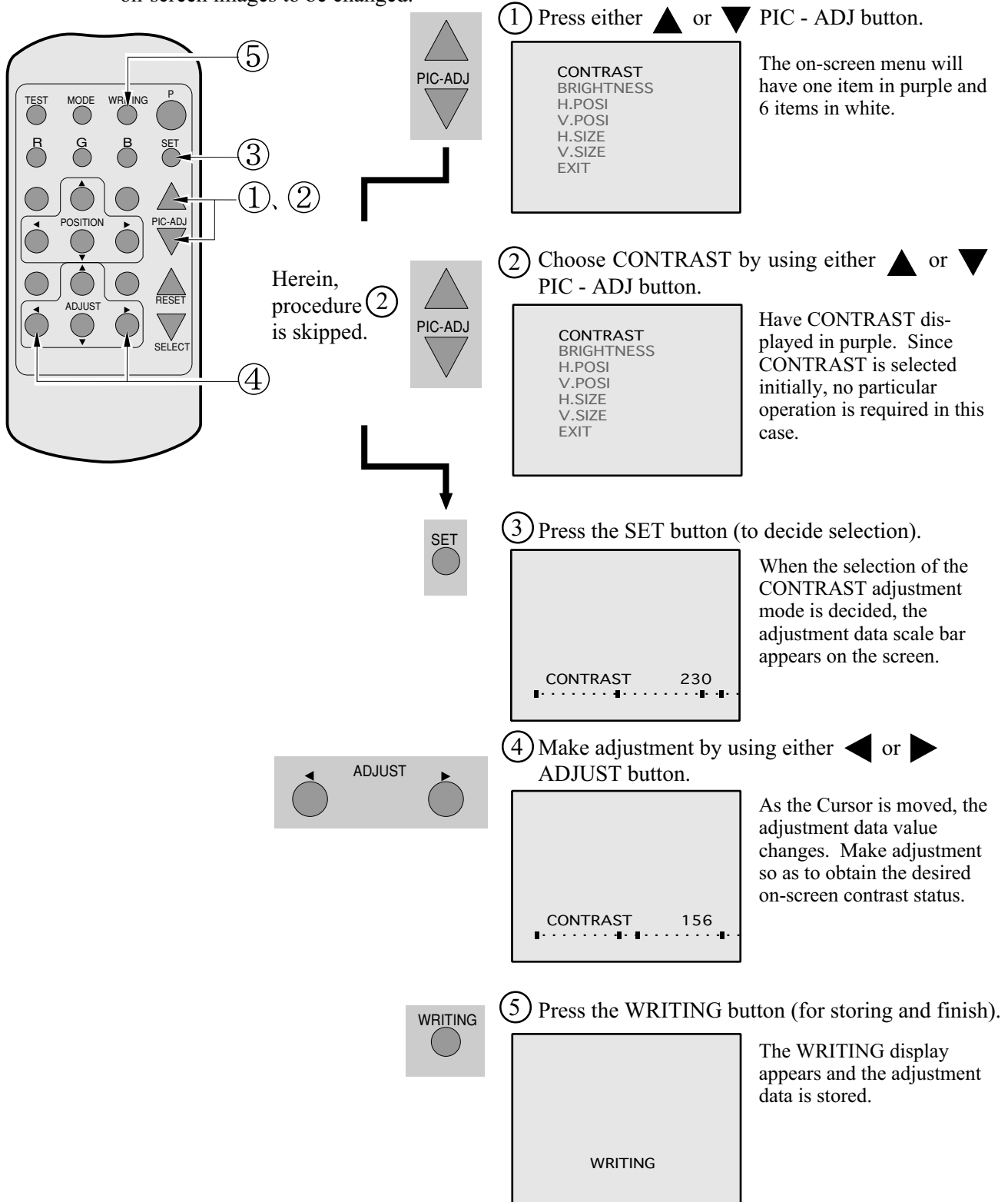

- When discontinuing the adjustment, choose EXIT from the menu at the stage of procedure ② and press the SET button.
- To continue adjusting other menu items, repeat procedure ② ~ ④.
- Unless the adjustment data is stored, the data in the adjusted status will be erased at the time the power is turned off and the pre-adjustment status will remain when the power is turned on next time.

ADJUSTING THE SCREEN BRIGHTNESS

Although the on-screen picture quality has been adjusted at the time of shipment from the factory, readjustment can be made if desired. When the Game Board is replaced, readjustment may be necessary. Changing the BRIGHTNESS causes the brightness of the on-screen images of black portions to be changed.

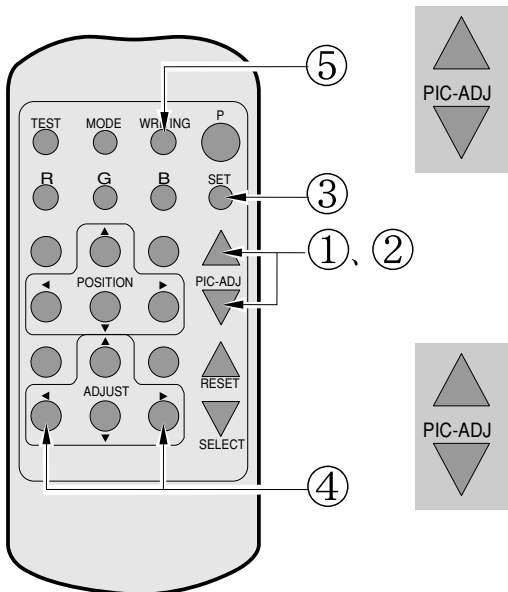

① Press either ▲ or ▼ PIC - ADJ button.



The on-screen menu will have one item in purple and 6 items in white.

② Choose BRIGHTNESS by using either ▲ or ▼ PIC - ADJ button.



Have the BRIGHTNESS displayed in purple.

③ Press the SET button (to decide selection).

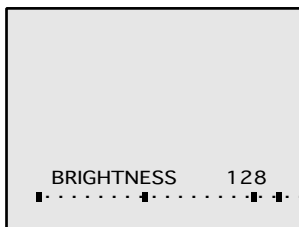

When the selection of the BRIGHTNESS adjustment mode is decided, the adjustment data scale bar appears on the screen.

④ Make adjustment by using either ◀ or ▶ ADJUST button.

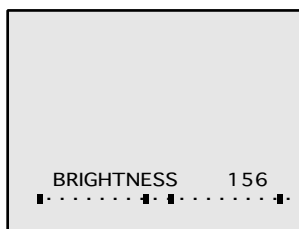

As the Cursor is moved, the adjustment data value changes. Make adjustment so as to obtain the desired on-screen brightness status.

⑤ Press the WRITING button (for storing and finish).

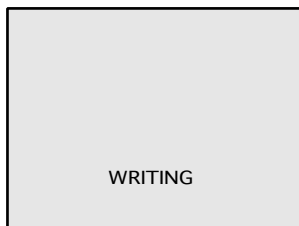

The WRITING display appears and the adjustment data is stored.

- When discontinuing the adjustment, choose EXIT from the menu at the stage of procedure ② and press the SET button.
- To continue adjusting other menu items, repeat procedure ② ~ ④.
- Unless the adjustment data is stored, the data in the adjusted status will be erased at the time the power is turned off and the pre-adjustment status will remain when the power is turned on next time.

ADJUSTING THE ON-SCREEN DISPLAY POSITION

Although the on-screen display position (H. POSI, V. POSI) has been adjusted at the time of shipment from the factory, readjustment can be made if desired. When the Game Board is replaced, readjustments may be necessary.

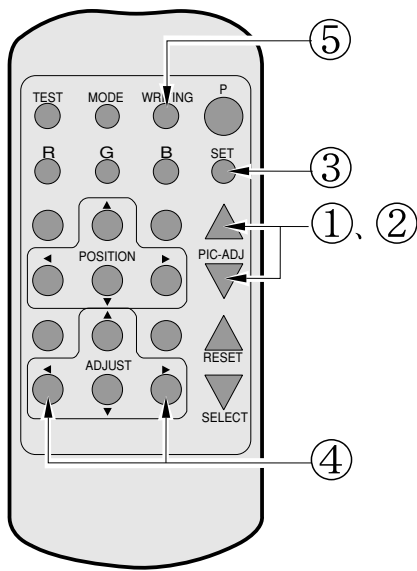

① Press either ▲ or ▼ PIC - ADJ button.

The on-screen menu will have one item in purple and 6 items in white.

```

CONTRAST
BRIGHTNESS
H.POSI
V.POSI
H.SIZE
V.SIZE
EXIT
    
```

② Choose H. POSI or V. POSI by using either ▲ or ▼ PIC ADJ button.

Have the H. POSI or V. POSI displayed in purple. The Figure shows the status in which H. POSI is selected.

```

CONTRAST
BRIGHTNESS
H.POSI
V.POSI
H.SIZE
V.SIZE
EXIT
    
```

③ Press the SET button (to decide selection).

When the selection of the H. POSI or V. POSI is decided, the adjustment data scale bar appears on the screen.

```

H.POSI 128
┌───────────┴───────────┐
    
```

④ Make adjustment by using either ◀ or ▶ ADJUST button.

As the Cursor is moved, the adjustment data value changes. Make adjustment so as to obtain the desired on-screen position status.

```

H.POSI 156
┌───────────┴───────────┐
    
```

When making adjustments in vertical directions, also use either ◀ or ▶ ADJUST button.

⑤ Press the WRITING button (for storing and finish).

The WRITING display appears and the adjustment data is stored.

```

WRITING
    
```

- When discontinuing the adjustment, choose EXIT from the menu at the stage of procedure ② and press the SET button.
- To continue adjusting other menu items, repeat procedure ② ~ ④.
- Unless the adjustment data is stored, the data in the adjusted status will be erased at the time the power is turned off and the pre-adjustment status will remain when the power is turned on next time.

ADJUSTING THE SCREEN SIZE

Although the on-screen size (H. SIZE, V. SIZE) has been adjusted at the time of shipment from the factory, readjustment can be made if desired. When the Game Board is replaced, readjustments may be necessary.

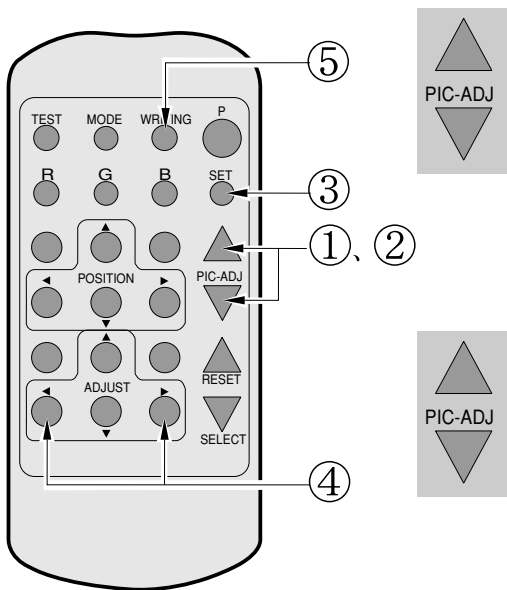

① Press either ▲ or ▼ PIC - ADJ button.

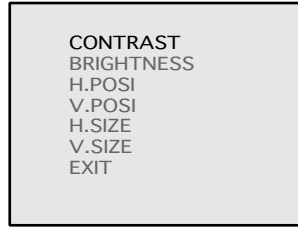

The on-screen menu will have one item in purple and 6 items in white.

② Choose H. SIZE or V. SIZE by using either ▲ or ▼ PIC - ADJ button.



Have the H. SIZE or V. SIZE displayed in purple. The Figure shows the status in which H. SIZE is selected.

③ Press the SET button (to decide selection).

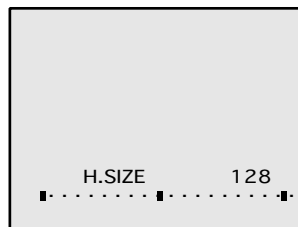

When the selection of the H. SIZE or V. SIZE adjustment mode is decided, the adjustment data scale bar appears on the screen.

④ Make adjustment by using either ◀ or ▶ ADJUST button.

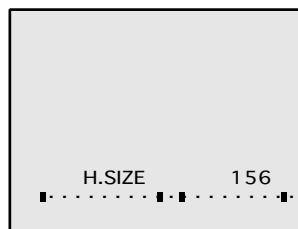

As the Cursor is moved, the adjustment data value changes. Make adjustment so as to obtain the desired on-screen position status.

⑤ Press the WRITING button (for storing and finish).

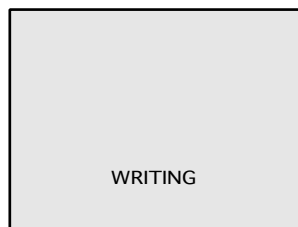

The WRITING display appears and the adjustment data is stored.

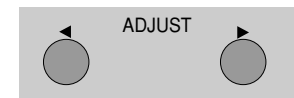

When making adjustments in vertical directions, also use either ◀ or ▶ button.

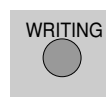

- When discontinuing the adjustment, choose EXIT from the menu at the stage of procedure ② and press the SET button.
- To continue adjusting other menu items, repeat procedure ② ~ ④.
- Unless the adjustment data is stored, the data in the adjusted status will be erased at the time the power is turned off and the pre-adjustment status will remain when the power is turned on next time.

CONVERGENCE ADJUSTMENT (manual color matching)



To avoid circuitry malfunctioning due to electrical load increase, never utilize CONVERGENCE ADJUSTMENT (Line Convergence Adjustment in particular) for adjusting screen size changes.

There is no means to restore the Convergence Adjustment data once stored, to its original state. To avoid changing the screen size by erroneously using convergence adjustment, do not perform the green Line Convergence Adjustment.

As such, be sure to perform the adjustment work from this page onward by the Technical staff and the location's Maintenance Personnel who are well versed in such adjustment work. In the Static Convergence Adjustments, if satisfactory adjustments can not be performed, do not make another convergence adjustments inadvertently. Contact the office herein stated or where the product was purchased from.



- To avoid making the adjustment work ineffective, do not press the RESET button during adjustment.
- To discontinue adjustment work, keep pressing the TEST button for approximately 3 seconds at the stage before storing the adjustment data by pressing the WRITING button.
- Should the screen be abnormally disturbed by noise due to static electricity, etc., turn the power off without storing the adjustment data.
- Pressing the or PIC - ADJ button in the Convergence Adjustment mode status will display the Adjustment Menu shown right. Do not utilize this Adjustment Menu as this is the one applied at the factory.

Adjusting this menu causes the Customer's adjustment range to be deviated.

Should the menu shown right be displayed by mistake, first choose EXIT by using either or PIC - ADJ button and then press the SET button.

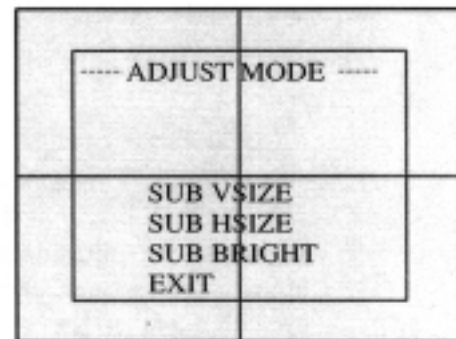

Adjustment menu used in the factory.

STATIC CONVERGENCE ADJUSTMENT

In the static convergence adjustment, each of red and blue images is comprehensively moved to and superimposed on the green color. If automatic color matching function is not sufficiently satisfactory, perform this adjustment. Be sure to perform automatic color matching before starting the above adjustment.

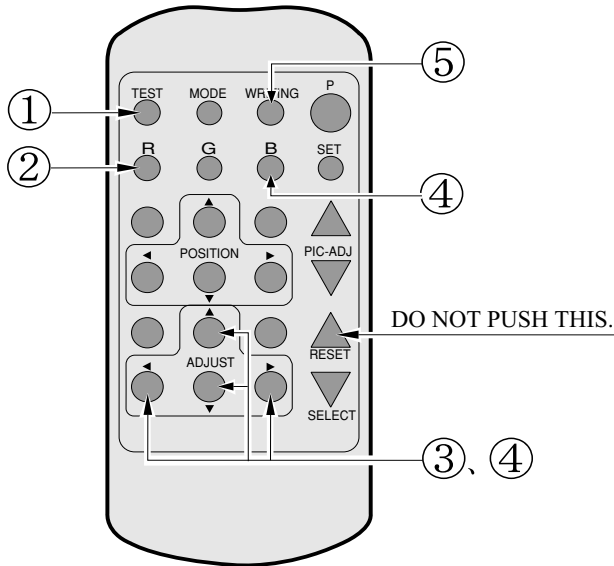

When either of (2) (4) COLOR SELECT buttons (R, B) is pressed, if the color desired to be adjusted disappears, press that particular button again. For example, if the red color needs to be adjusted again at the stage of (4), the R button need to be pressed twice.

Keep pressing the TEST button for approximately 3 seconds.

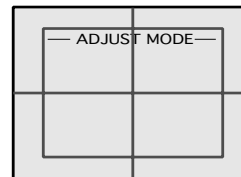

The screen will change to ADJUST mode from the Game mode to cause the green test pattern to be displayed on the screen.

Press the R button to have the red adjustment mode.

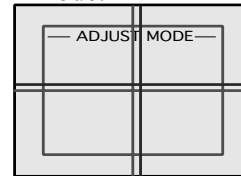

The red test pattern is added to the display. The frame color turns red and this signifies the red adjustment mode.

Make adjustment by using the ▲ ▼ ◀ ▶ ADJUST buttons.

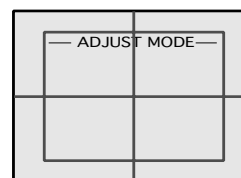

Make adjustment so as to have red superimposed on green. When red is superimposed on green, the color becomes yellow.

Press the B button to have the blue adjustment mode.

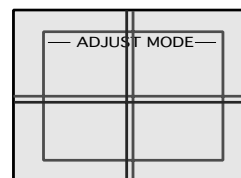

Similarly as in the case of red, adjust the blue color. When green, red, and blue are superimposed, the color becomes white.

Press the WRITING button (for storing and finish).

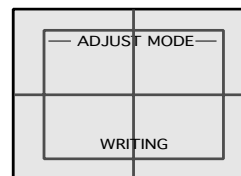

The WRITING display appears and the adjustment data is stored. After the data is stored, the Game mode returns.

POINT CONVERGENCE ADJUSTMENT

In the POINT CONVERGENCE adjustment, each of red, green and blue images is partially moved for color matching. The adjustment may be necessary when the Game Board is replaced or changed, or screen size is changed. Be sure to perform automatic color matching before starting the adjustment.

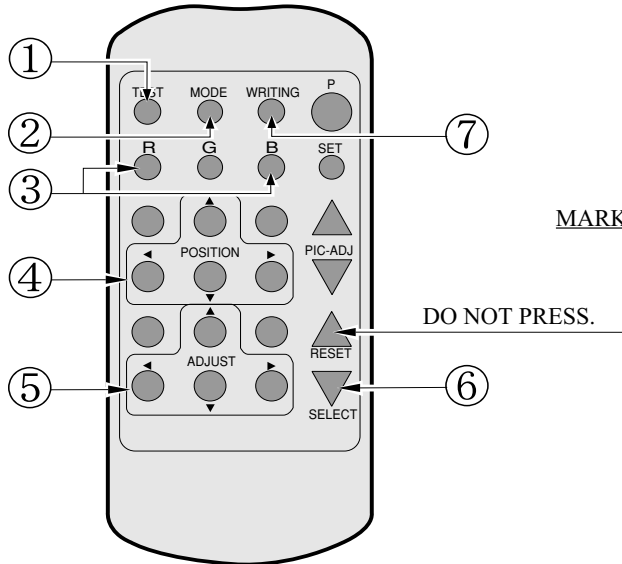

Note 1 When the MODE button is repeatedly pressed, the adjustment modes will circulate as follows:

```

    STATIC ADJUSTMENT MODE
    |
    LINE ADJUSTMENT MODE
    |
    POINT ADJUSTMENT MODE
  
```

Note 2 When either of the COLOR SELECT buttons (R, B) is pressed, if the desired color to be adjusted disappears, press that particular button again.

Note 3 By repeatedly pressing the SELECT button, only the Projector's TEST pattern screen and the screen superimposing the Game Board Test pattern can be alternately displayed.

- Keep pressing the TEST button for approximately 3 seconds.

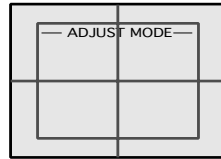

The screen changes to ADJUST mode from the Game mode and displays the green test pattern.

- Press the MODE button twice to have the POINT ADJUSTMENT mode. Note 1

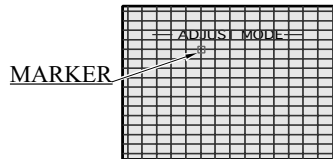

The crosshatch test pattern appears and the MARKER indicating the adjustment point is displayed.

- Using either R or B button, select the desired color to be adjusted. Note 2 By using the G button, the green color can also be selected.

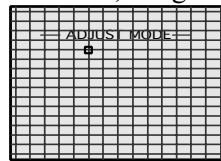

The selected color is displayed by superimposing on green. The MARKER will be in the color selected.

- By using the ▲ ▼ ◀ ▶ ADJUST buttons, move the MARKER to the position to be adjusted.

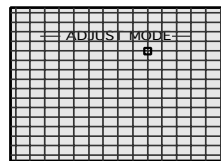

The MARKER moves in the direction of the button's arrow. However, the movable point is predetermined.

- Make adjustment by using the ▲ ▼ ◀ ▶ ADJUST buttons.

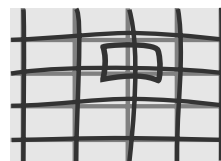

Although the direct vicinity of the MARKER's center moves most conspicuously, make adjustment by paying attention to the periphery area also. Shown left is the magnified MARKER periphery.

- Press the SELECT button as necessary to superimpose Game Board images. Note 3

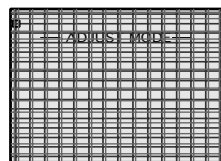

If the test pattern is not displayed in the periphery of the screen, adjustments can be made by pressing the SELECT button to superimpose the test pattern and the Game Board's CRT test screen.

- Press the WRITING button (for storing and finish).

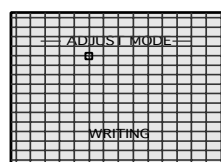

WRITING is displayed and the adjustment data is stored. After the data is stored, the Game Board screen returns.

LINE CONVERGENCE ADJUSTMENT

In the LINE CONVERGENCE ADJUSTMENT, the adjustment point of the column line (vertical) or row line (horizontal) is comprehensively moved for color matching. It is convenient to utilize this adjustment when the color of the column line or row line is uniformly deviated.

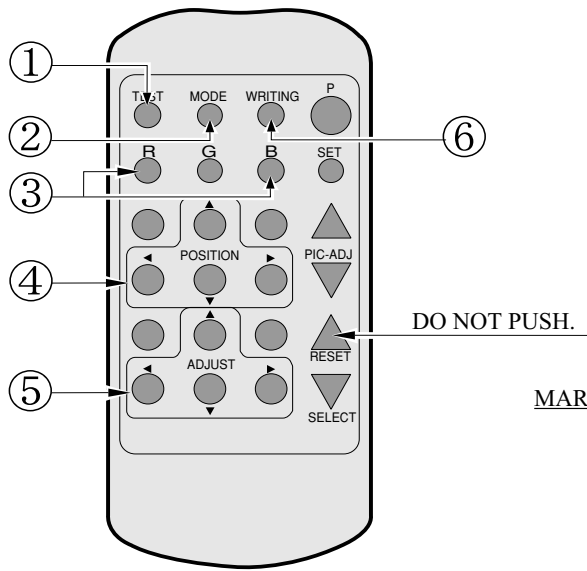

Note 1 When the MODE button is repeatedly pressed, the adjustment modes will circulate as follows:

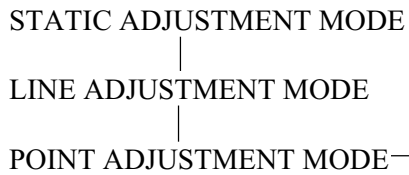

Note 2 When either of the COLOR SELECT buttons (R, B) is pressed, if the desired color to be adjusted disappears, press that particular button again.

① Keep pressing the TEST button for approximately 3 seconds.

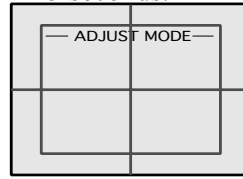

The screen changes to ADJUST mode from the Game Board mode and displays the green test pattern.

② Press the MODE button once to have the POINT ADJUSTMENT mode. Note 1

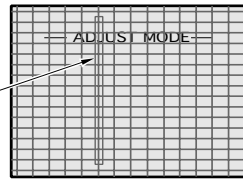

The crosshatch test pattern appears and the vertically long MARKER is shown.

③ Using either R or B button, select the desired color to be adjusted. Note 2 Although the green color can also be selected by using the G button, to avoid the screen size change adjustment, do not choose green.

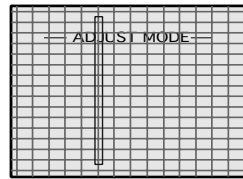

The selected color is displayed by superimposing on green. The MARKER will be in the color selected.

④ By using the ▲ ▼ ◀ ▶ POSITION buttons, move the MARKER to the position to be adjusted.

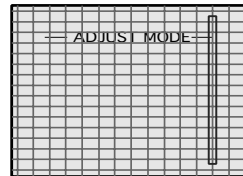

Use the ◀ ▶ buttons to select the column line, and the MARKER moves in the right/left direction. However, the movable range is predetermined.

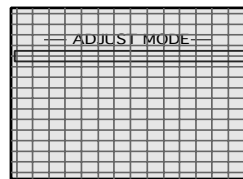

Use the ▲ ▼ buttons to select the row line and the MARKER moves in the up/down direction. However, the movable range is predetermined.

⑤ Make adjustment by using the ▲ ▼ ◀ ▶ ADJUST buttons.

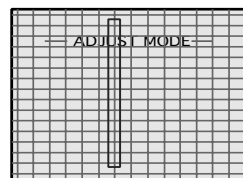

The selected column line or row line (shown left is the column line) can be moved in the desired up/down or right/left directions as applicable.

⑥ Press the WRITING button (for storing and finish).

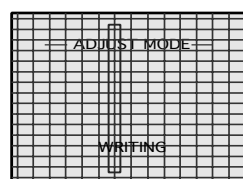

WRITING is displayed and the adjustment data is stored. After the data is stored, the Game Board screen returns.



- For the operation of Remote Control, use only the Keys of R/B, ▲ (UP shift), ◀ (LEFT shift), ▼ (DOWN shift), ▶ (RIGHT shift), TEST, -, +, and PICTURE. Do not press keys other than those explained in this manual.
- When operating the Remote Control, have it point the screen.

The Projector has DYNAMIC CONVERGENCE adjustment functions. This manual does not refer to the functions as the adjustment of DYNAMIC CONVERGENCE is very troublesome and in addition, visual effects are negligible.

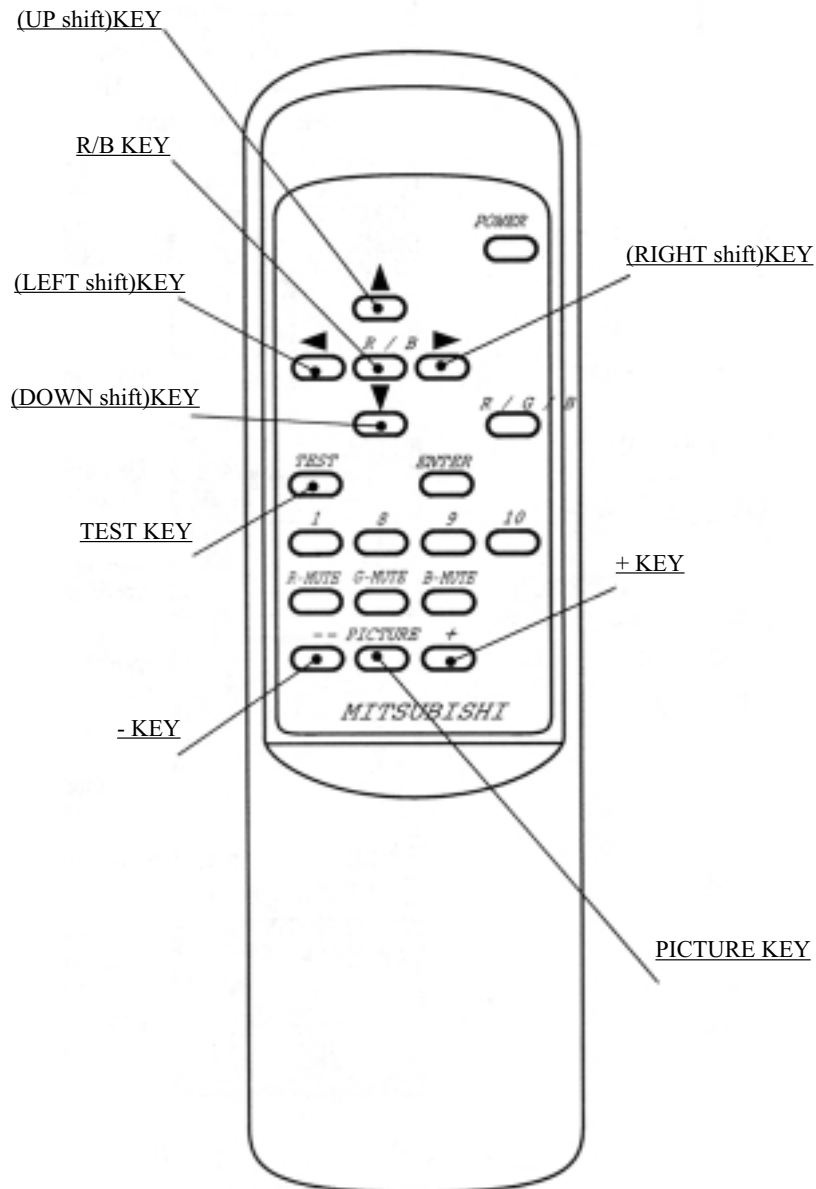

- POWER KEY This does not have power ON/OFF function. Does not function even if it is pressed.
- R/B KEY Used to select "R" for red adjustment or "B" for blue adjustment in the STATIC CONVERGENCE ADJUSTMENT mode.
- ▲(UP shift) KEY Used to move the test cross upward in the STATIC CONVERGENCE ADJUSTMENT mode.
- ◁(LEFT shift) KEY Used to move the test cross to the left in the STATIC CONVERGENCE ADJUSTMENT mode.
- ▼(DOWN shift)..... Used to move the test cross downward in the STATIC CONVERGENCE ADJUSTMENT mode.
- ▷(RIGHT shift) KEY Used to move the test cross to the right in the STATIC CONVERGENCE ADJUSTMENT mode.
- TEST KEY This is the ON/OFF key in the STATIC CONVERGENCE ADJUSTMENT mode. In the ON status of this key, the test cross pattern appears in the approximately on-screen center.
- ENTER KEY Used for DYNAMIC CONVERGENCE.
- - KEY Used to decrease the adjustment data in the adjustment mode of CONTRAST, BRIGHTNESS, HORIZONTAL/VERTICAL POSITIONS and WIDTH.
- + KEY Used to increase the adjustment data in the adjustment mode of CONTRAST, BRIGHTNESS, HORIZONTAL/VERTICAL POSITIONS and WIDTH.
- PICTURE KEY Used for the ADJUSTMENT mode of CONTRAST, BRIGHTNESS, HORIZONTAL/VERTICAL POSITIONS and WIDTH. Every time this key is pressed, the ADJUSTMENT mode proceeds as follows:

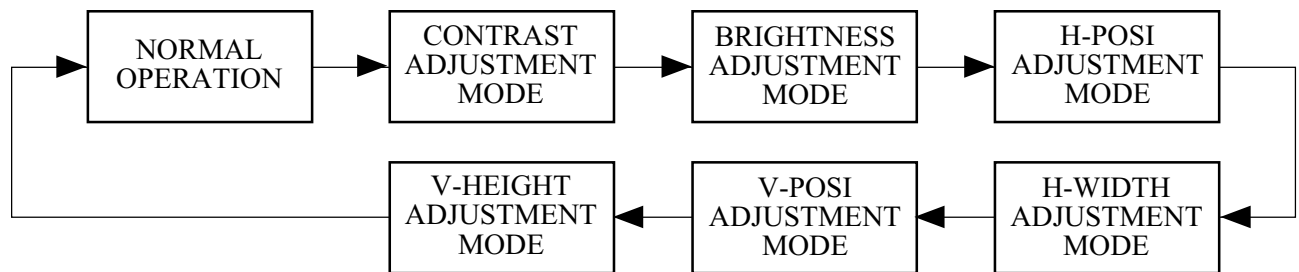

EXPLANATIONS OF ADJUSTMENT MODES

- CONTRAST Used to vary image contrast. Use + and - keys to adjust.
- BRIGHTNESS Used to change image brightness. Use + and - keys to adjust.
- H-POSI Used to move the image position in the horizontal direction. Use + and - keys to adjust.
- H-WIDTH Used to change the horizontal width of image. Use + and - keys to adjust.
- V-POSI Used to move the image position in the vertical direction. Use + and - keys to adjust.
- V-HEIGHT Used to change the vertical width of image. Use + and - keys to adjust.

STATIC CONVERGENCE ADJUSTMENT

Press the TEST KEY to change the screen to Red Line Adjustment mode.

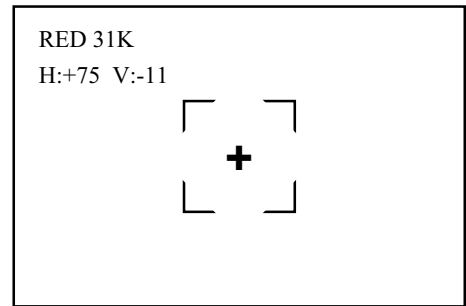

Superimpose the red line on the green line.
When the red line is superimposed on the green line, the green line turns to yellow or white.

To MOVE RED LINE:

- Use ◁ key to move it left.
- Use ▷ key to move it right.
- Use ▲ key to move it upward.
- Use ▼ key to move it downward.

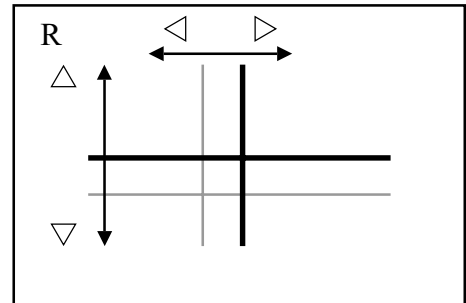

Press the R/B KEY.

Changes to the Blue Line Adjustment screen.

Every time the key is pressed, "from red to blue" and "from blue to red" are alternated.

SUPERIMPOSING BLUE LINE ON GREEN LINE:

Superimposing blue line on green line causes the green line to turn to white.

TO MOVE BLUE LINE:

- Use ◁ key to move it left.
- Use ▷ key to move it right.
- Use ▲ key to move it upward.
- Use ▼ key to move it downward.

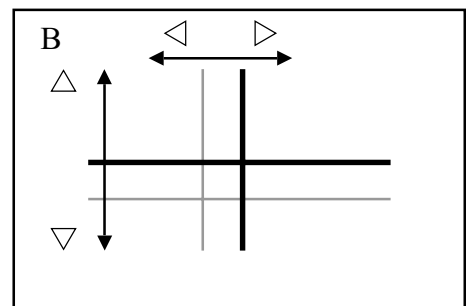

Press the TEST KEY.

Adjustment is finished.

AUTOMATIC CANCELLATION OF ADJUSTMENT MODE

In each adjustment mode, only in the case where an effective key input (variation of values and images) is not performed within the time limit indicated below, the adjustment mode is automatically cancelled and finished, shifting to on-screen normal images.

Approximately 6 seconds CONTRAST
 BRIGHTNESS
 H-POSI
 H-WIDTH
 V-POSI
 V-HEIGHT

Approximately 5 min. STATIC CONVERGENCE

13. COIN SELECTOR

HANDLING THE COIN JAM

If the coin is not rejected when the REJECT button is pressed, open the coin chute door and open the selector gate. After removing the jammed coin, put a normal coin in and check to see that the selector correctly functions.

CLEANING THE COIN SELECTOR



- Remove and clean smears by using a soft cloth dipped in water or diluted chemical detergent and then squeezed dry.
- Never apply machine oil, etc. to the Coin Selector.
- After cleaning the Coin Selector, insert a regular coin in the normal working status and ensure that the Selector correctly functions.

The coin selector should be cleaned once every 3 months. When cleaning, follow the procedure below:

- ① Turn the power for the machine OFF. Open the coin chute door.
- ② Open the gate and dust off by using a soft brush (made of wool, etc.).
- ③ Remove and clean smears by using a soft cloth dipped in water or diluted chemical detergent and then squeezed dry.
- ④ Remove the CRADLE.
When removing the retaining ring (E ring), be very careful so as not to bend the rotary shaft.
- ⑤ Remove stain from the rotary shaft and shaft receiving portions by wiping off with a soft cloth, etc.
- ⑥ After wiping off as per ⑤ above, further apply a dry cloth, etc. to cause the coin selector to dry completely.

COIN INSERTION TEST

Once every month, when performing the Coin SW Test, simultaneously check the following:

- Does the Coin Meter count satisfactorily?
- Does the coin drop into the Cashbox correctly?
- Is the coin rejected when inserted while keeping the Reject Button pressed down?

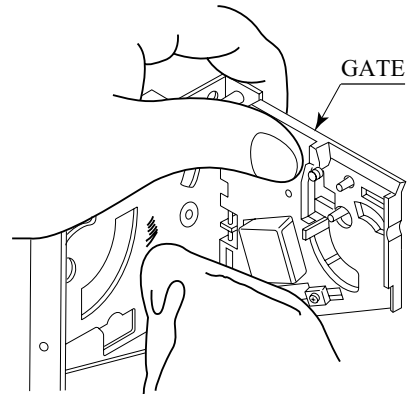

FIG. 13 a

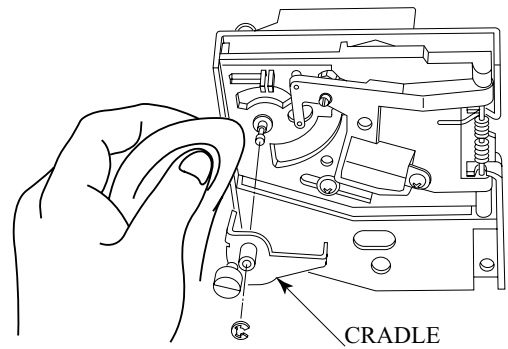
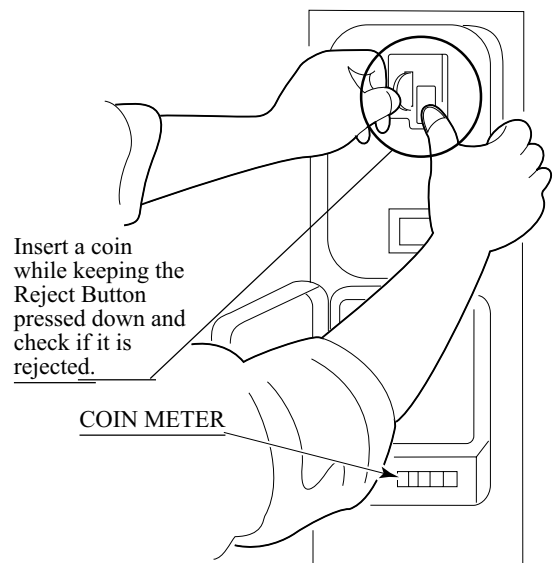

FIG. 13 b



Insert a coin while keeping the Reject Button pressed down and check if it is rejected.

FIG. 13 c

**WELLS-GARDNER
ELECTRONICS CORPORATION**

2701 N. KILDARE CHICAGO, IL 60639

1-800-336-6630

WWW.WGEC.COM

WGD15-2110-01

OVER/UNDER MINI DOOR

2 ENTRIES WITH BILL

VALIDATOR BOTTOM DOOR

& SPECIAL ENCLOSURE

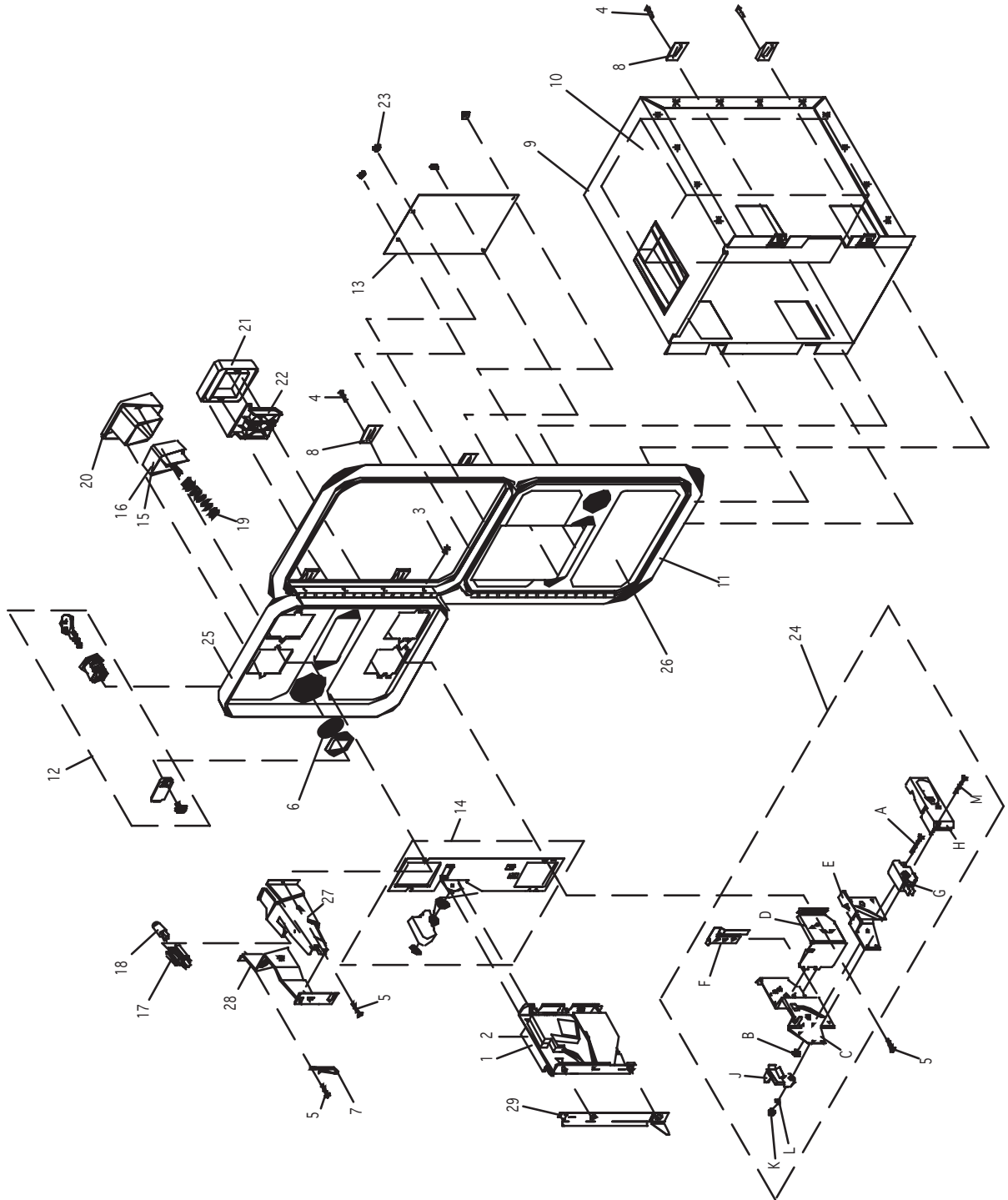

#	WG. PART #	DESCRIPTION
1	812-4150-011	S-7 US 25c COIN MECH LEFT
2	812-4050-011	S-10 US \$1 COIN MECH RIGHT
3	890-1002-00	HINGE SCREW
4	890-1003-00	CLAMP SCREW
5	890-1017-00	SCREW TRILOBULAR
6	890-1019-00	WASHER INTERNAL TOOTH 3/4"
7	890-1300-00	KEYHOOK
8	891-0514-00	CLAMP UK 5/8" CABINET
9	025X3711-001	ENCLOSURE W/CHUTE
10	025X3712-001	METAL CASHBOX
11	891-0509-162	DOUBLE FRAME
12	891-0547-00	LOCK SINGLE BIT
13	891-0100-4016	COVER PLATE
14	891-1008-107	BASE PLATE ASSEMBLY
15	891-1113-03	E/R BUTTON US 4x25c/\$1 LEFT
16	891-1113-011	E/R BUTTON US \$1 COIN RIGHT
17	891-1117-00	LAMPHOLDER
18	891-1118-00	LAMP WEDGE BASE 6 VOLT
19	891-1121-00	SPRING, E/R BUTTON
20	891-1311-16	BUTTON BEZEL NYLON
21	891-1312-16	REJECT BEZEL NYLON
22	891-1109-16	REJECT FLAP
23	020X1877-005	NUT KEYS #8-32 X 5/16 HEX
24	891-2216-16	MICROSWITCH ASSEMBLY
24A	890-1007-00	SCREW FLAT HEAD W/S
24B	890-1206-02	KEP NUT
24C	891-1105-01	REJECT CUP SIDE PLATE
24D	891-1106-00	REJECT CUP BASE PLATE
24E	891-1107-00	BRACKET, MICROSWITCH
24F	891-1110-00	ADJUSTER, COIN
24G	891-1116-16	MICROSWITCH, BLACK - MED.
24H	891-1125-00	COVER, PLASTIC
24J	892-1002-07	CLIP, SNAP-ON
24K	892-1002-08	ELASTIC SNAP NUT
24L	892-1002-09	SLEEVE, SNAP-ON
24M	892-1002-11	SCREW, PAN HEAD
25	891-0604-16	MINI DOOR 2 ENTRIES
26	891-0614-16	MINI DOOR W/DBV C/O
27	892-1002-01	BRACKET, LAMP SIDE
28	892-1002-021	BRACKET, COVERSIDE
29	892-1002-10	BRACKET, HOLD DOWN

Tom Happ
 tom.happ@happcontrols.com
 Happ Controls, 106 Garlich Drive, Elk Grove, IL 60007
 Visit our website <http://www.happcontrols.com>

Ph: 847-593-6161 ext. 107

Fx: 847-956-2091

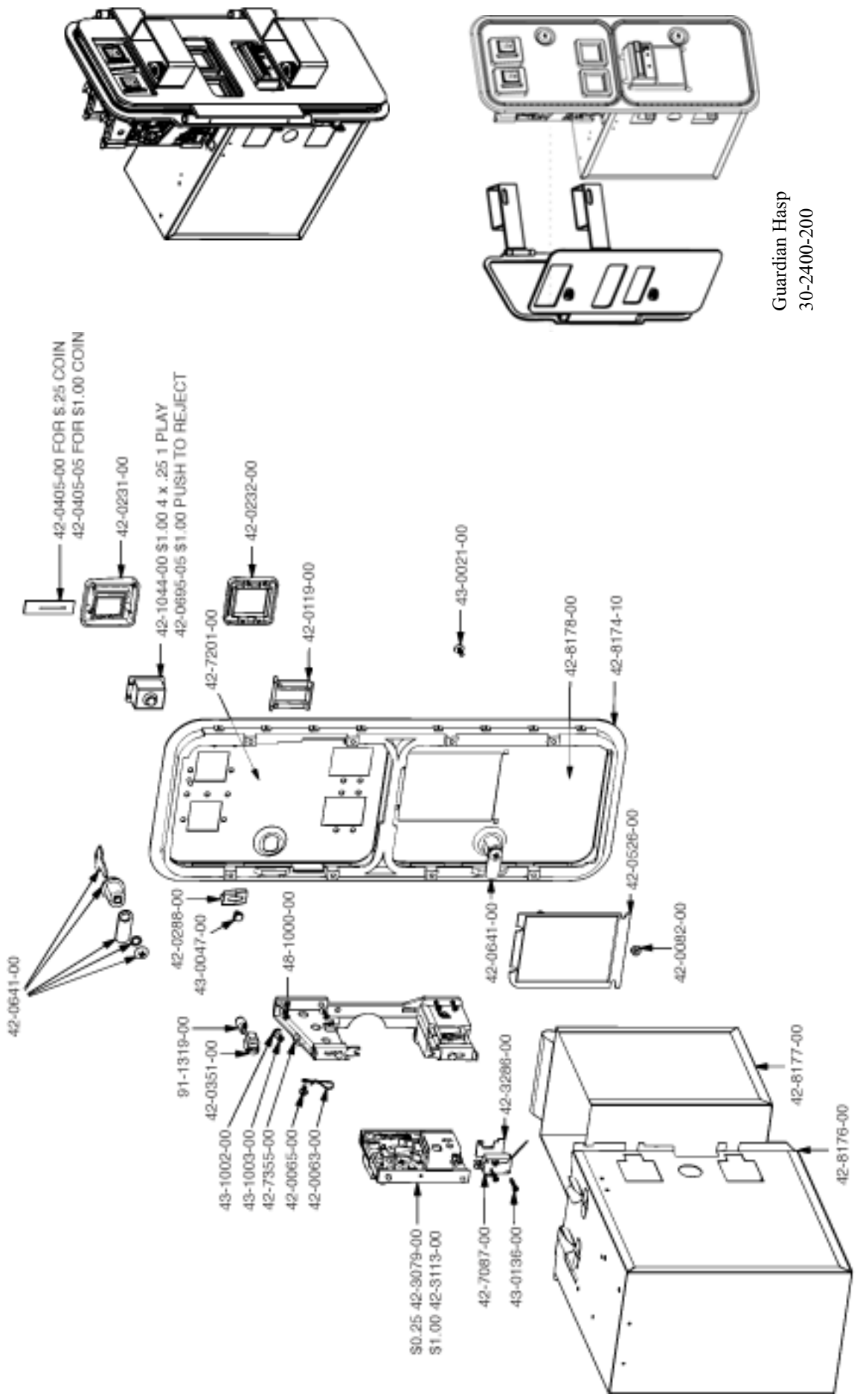

Guardian Hasp
 30-2400-200

OPTIONAL DOLLAR BILL ACCEPTOR

- THE COIN DOOR ASSEMBLY USED ON **CLUB KART DX** COMES EQUIPPED TO ACCEPT A DOLLAR BILL ACCEPTOR. ALL NEEDED WIRING CONNECTIONS ARE CONVENIENTLY LOCATED INSIDE THE GAME FOR THIS APPLICATION.
- THE COIN DOOR CAN ACCCOMMODATE THE FOLLOWING VALIDATOR(S):

FORWARD-MOST
HOLE POSITION

Mars 2000 series

**42-1155-00 MARS VALIDATOR \$1, 2, 5 300 CAP

The frame and cashbox enclosure on this coindoor has been modified to accomodate a Mars 2000 series upstacker. A 2000 series stacker can be added by simply removing the cut-out plate. This one entry door can be ordered through Happ Controls or one of Happ Controls authorized distributors. The part number is 40-6000-10EX. The Mars stacker can be obtained through an authorized Mars distributor.

Note: Your game may have either Happ Controls Coin Door Assembly or the Wells Gardner Coin Door Assembly (not shown).

**Happ part number

Security Locking Bar/Bracket Set Part No.# 999-0966

Modified Cash Box (For use when DBA installed)
Part No. # 999-1106

Plastic Cash Box - Full Size Part No. # 999-1177

****Coin door shown with optional dollar bill validator inserted****

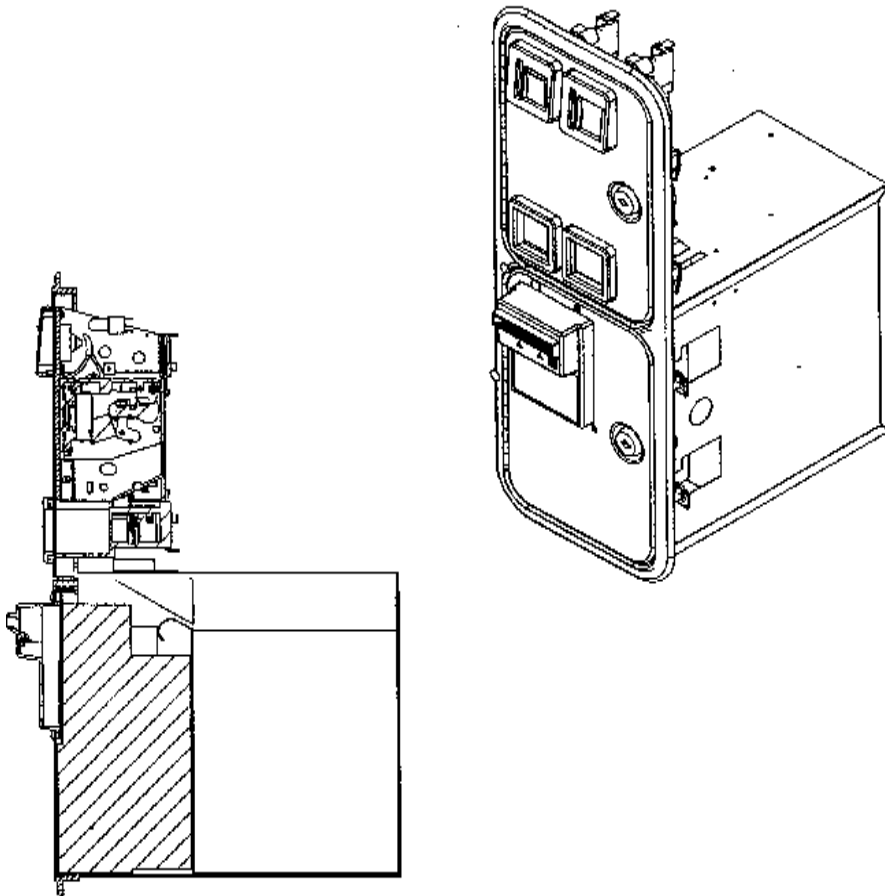

14. REPLACING THE FLUORESCENT LAMP, AND LAMPS



WARNING!

- When performing work, be sure to turn power off. Working with power on can cause electric shock and short circuit hazards.
- The Fluorescent Lamp, when it gets hot, can cause burn. Be very careful when replacing the Fluorescent Lamp.
- Be sure to use lamps of the designated rating. Using lamps of undesignated rating can cause a fire or malfunctioning.



CAUTION!

- To perform work safely and securely, be sure to prepare a step which is in a secure and stable condition. Performing work without using the step can cause violent falling down accidents.
- Be careful when handling the plastic made parts. Failure to observe this may cause injury due to damage or fragments resulting from damage.

INSIDE THE BILLBOARD

Remove the billboard holder, slide up the billboard plate, and replace the fluorescent tube.

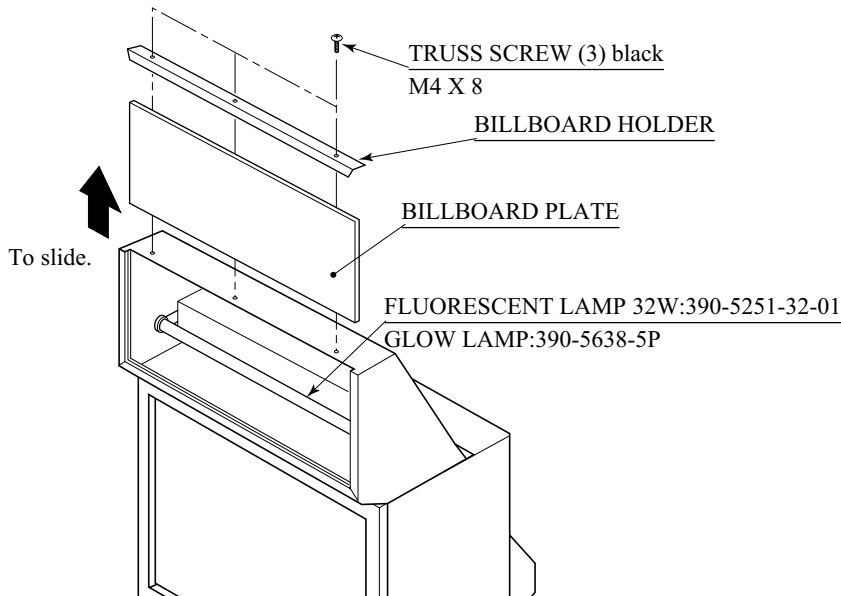

FIG. 14 a

START BUTTON,VIEW CHANGE BUTTON

- ① Turn power off.
- ② Remove the 4 Trusshead screws.

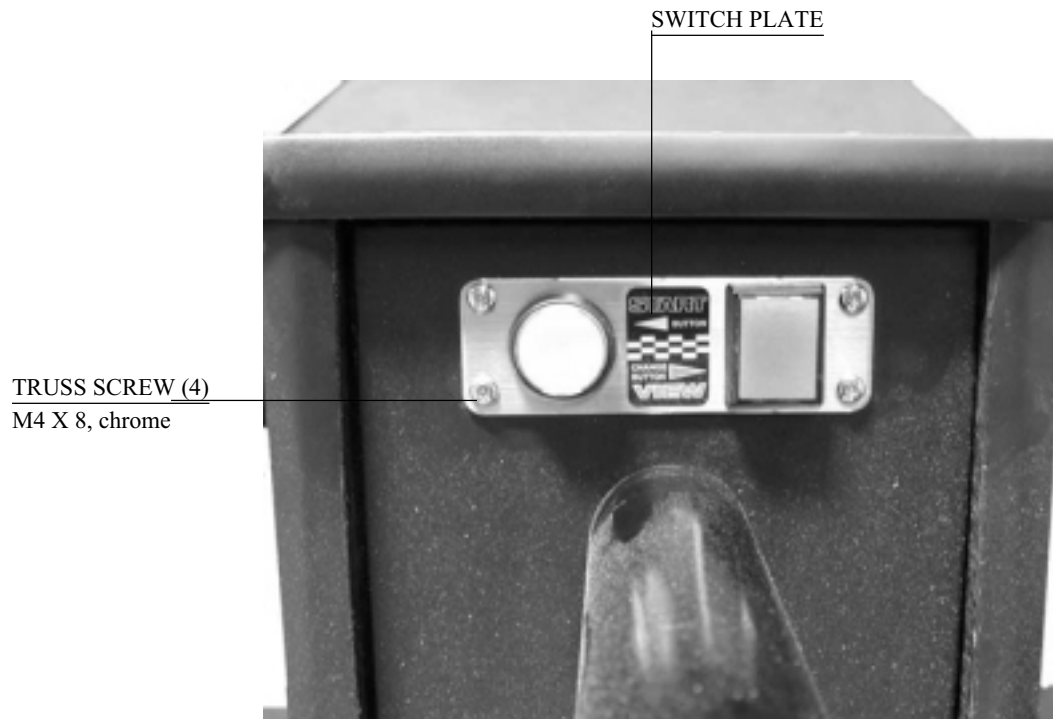

PHOTO 14 a

- ③ Remove the switch plate from the control panel carefully without damaging the wires.
- ④ On the rear side of the switch plate there is a metallic projection on the foot of each button. Turn the projection to unlock, and remove the wire connection part from the button body.
- ⑤ The lamp is inside the wiring connecting portion. Push and then turn the Lamp counterclockwise to remove.

15. PERIODIC INSPECTION TABLE

The items listed below require periodic check and maintenance to retain the performance of this machine and to ensure safe business operation.

When handling the controller, the player will be in direct contact with it . In order to always allow the player to enjoy the game, be sure to clean it regularly. Also, it is advisable to provide wet tissue, etc. available for player use.



WARNING!

- Be sure to check once a year to see if Power Cords are damaged, the plug is securely inserted, dust is accumulated between the Socket Outlet and the Power Plug, etc. Using the product with dust as is accumulated can cause fire and electric shock hazards.
- Periodically once a year, request the place of contact herein stated or the Distributor, etc. where the product was purchased from, as regards the internal cleaning. Using the product with dust as is accumulated in the interior without cleaning can cause a fire or accident. Note that cleaning the interior parts can be performed on a pay-basis.

TABLE 15

	Item	Interval	Reference
CABINET	Check Adjusters'contact with surface.	Daily	3
CONTOROL PANEL	Cleaning	As necessary	
	Inspection of SW, VR.	Monthly	9
	Greasing to the gear mesh portion.	Trimonthly	10-2
ACCEL. & BRAKE	Check VOLUME VALUE.	Monthly	9
	Gear and Spring portion greasing	Trimonthly	11-2
COIN CHUTE DOOR	Check COIN SW.	Monthly	9
	Coin insertion test.	Monthly	13
	Cleaning of COIN SELECTOR.	Trimonthly	13
PROJECTOR	SCREEN cleaning.	Weekly	12-1
	Check adjustments.	Monthly or when moving.	6, 9, 11
SEAT	Greasing to the seat rail	Trimonthly	FIG.15
GAME BD	MEMORY TEST.	Monthly	9
	Check settings.	Monthly	9
INTERIOR	Cleaning	Annually	See above.
POWER SUPPLY PLUG	Inspection and cleaning		
Cabinet surfaces	Cleaning	As necessary.	See below.

CLEANING THE CABINET SURFACES

When the cabinet surfaces are badly soiled, remove stains with a soft cloth dipped in water or diluted (with water) chemical detergent and squeezed dry. To avoid damaging surface finish, do not use such solvents as thinner, benzine, etc. other than ethyl alcohol, or abrasives, bleaching agent and chemical dustcloth.

SEAT (Greasing to Seat Rail Portion)

Move the Seat to the rearmost portion and apply spray greasing to the portion shown at the right once every 3 months by using NOK KLUBER L60 or GREASE MATE SEGA PART No. 090-0066. After greasing, move the Seat a few times forward and backward so as to allow the grease to be applied all over uniformly. Be sure to wipe grease which attaches to the surfaces of the PROTECT RUBBER on the Seat Rail, or any excess grease.

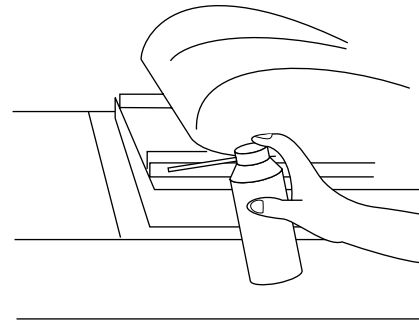

FIG. 15

16. TROUBLESHOOTING



- In order to prevent electric shock and short circuit, be sure to turn power off before performing work.
- Be careful so as not to damage wirings. Damaged wiring can cause electric shock or short circuit.
- After removing the cause of the functioning of the Circuit Protector, reinstate the Circuit Protector. Depending on the cause of the functioning, using the Circuit Protector as is without removing the cause can cause generation of heat and fire hazard.

In case a problem occurs, first check wiring connector connections.

TABLE 16 a

PROBLEMS	CAUSE	COUNTERMEASURES
With Main SW ON, no activation.	Power is not supplied. Power supply/voltage is not correct. The Circuit Protector functioned due to the momentary overload.	Securely insert the power plug into the plug socket. Make sure that power supply/voltage is correct. After eliminating the cause of overload, reinstate the AC Unit's Circuit Protector (see [4], Sec. 6, Refer to the following). Reset the circuit protector on the ASSY ELEC. (see PHOTO 16 a, b)
The color on PTV screen is incorrect.	Image adjustment is inappropriate.	Adjust appropriately (see Sec.12).
Color deviation on PTV screen.	Affected by peripheral machines or the building's steel frames.	Perform convergence adjustment (see Sec. 12). Change installation direction or position. Move the machine which causes the problem.
No sound is emitted.	Sound volume adjustment is not appropriate. Board and Amplifier malfunctioning.	Adjust sound volume (see Sec. 9). Perform the sound test and confirm (see Sec. 9).

TABLE 16 b

PROBLEMS	CAUSE	COUNTERMEASURES
Operability of the Steering wheel (handle) is poor.	Deviation of the volume value. Volume gear engagement fault. Volume malfunctioning.	Adjust the volume value in the Test mode. (see 9-3) Adjust the engagement of the gear. (see 10-2) Replace the Volume. (see 10-2)
Steering wheel (handle) is abnormal in its force feedback. It is not centered.	Failure of power-on checking procedure. The volume is not centered. Failure of the volume.	Reconnect the power, and complete a power-on checking procedure. (see 5 Sec. 6.) Adjust the volume value in the test mode. (see Sec. 9) Replace the volume. (see 10-1)
Steering wheel (handle) is weak in its force feedback.	Aging of the force feedback mechanism.	Reset in the test mode. (see Sec. 9)
Gas pedal (accelerator) and/or brake pedal do not operate normally.	The volume is not centered. Failure of the volume.	Adjust the volume value in the test mode. (see Sec. 9) Replace the volume. (see 11-1)
The Fluorescent lamp does not light up.	The Fluorescent tube is burnt out.	Replace the Fluorescent tube (see Sec. 14).
Lights integrated with the start button and the view change button do not come on.	The lamp is burnt out.	Replace the lamp. (see Sec.14)
Failure of the communication play.	Communication cables are disconnected. Communication cables are wrongly connected. Communication play is wrongly set.	Reconnect the cables. (see 19-2) Reconnect the cables correctly. (See 19-2) Reset correctly. (see 19-3)
'ERROR *' is displayed.	Setting error in the test mode.	Reset correctly in the test mode according to the product. (see Sec. 9)

FUSES on the ASSY ELEC



Carefully handle the PTV on the PTV base because it is very unstable. If handled carelessly, it may fall down and eventually cause a serious personal injury.

A circuit protector is located both in the AC unit and on the main cabinet's ASSY ELEC. If the connection of the power fails even though you have turned the main switch on, either circuit protector may have tripped. If the main switch does not function normally, check the circuit protector on the ASSY ELEC.

- ① Referring to Chapter 6, uncouple the main cabinet from the PTV. However, leave the wires connected.
- ② Remove the 2 trusshead screws to detach the front lid from the main cabinet

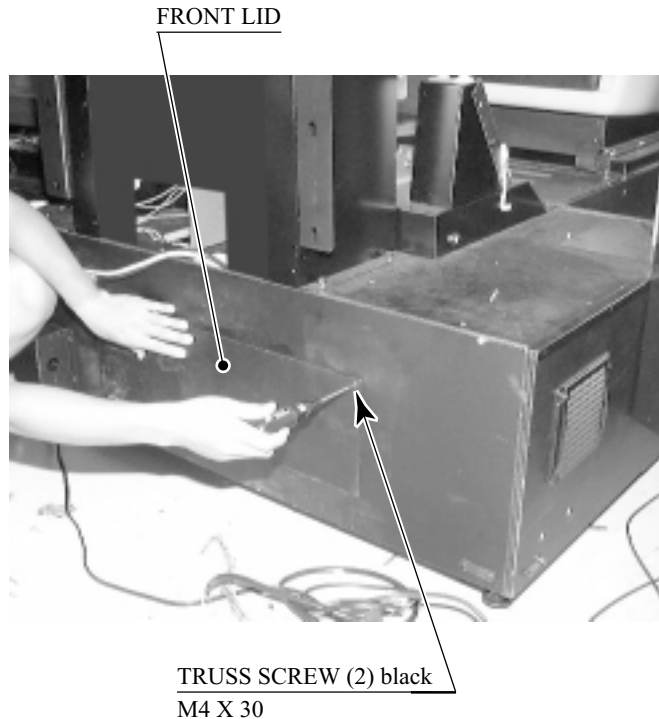
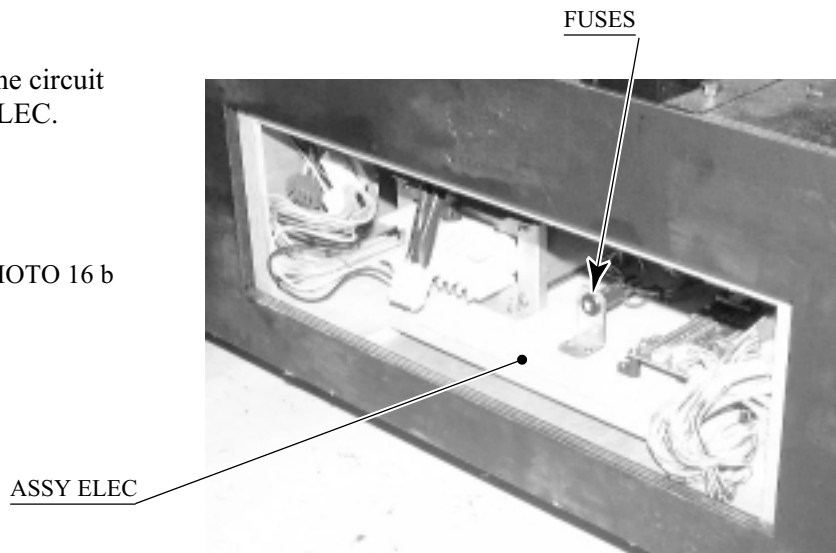

PHOTO 16 a

- ③ Now, you can access to the circuit protector on the ASSY ELEC.

PHOTO 16 b



17. GAME BOARD



WARNING!

- In order to prevent electric shock and short circuit hazards, be sure to turn power off before performing work.
- Be careful so as not to damage wirings. Damaged wiring can cause fire, electric shock and short circuit hazards.
- Do not expose the Game BD, etc. without a good reason. Failure to observe this can cause electric shock hazard or malfunctioning.



CAUTION!

The electronic parts on the IC Board could be damaged due to human body's static electricity. Before performing IC Board related work, be sure to discharge physically accumulated statics by touching grounded metallic surfaces, etc.



IMPORTANT

Put the Game Board in the Carton Box (an accessory) together with the Shield Case when requesting for the replacement or repair. Transporting the Game Board in an undesignated status for replacement/repair is unacceptable. In this manual, how to remove the Game Board is explained for convenience. However, this work should be performed by SEGA SERVICEMAN.

17 - 1 REMOVING THE GAME BOARD

- ① Turn power off.
- ② Remove the 2 trusshead screws of the back lid, unlock it, and detach it from the main cabinet.
- ③ Disconnect the connectors of all the wires between the ASSY MAIN BD DX and the main cabinet.
- ④ Disconnect the connectors of all the wires between the shield case's filter board on the ASSY MAIN BD DX and the main cabinet.
- ⑤ Remove the 2 wing bolts that fix the base (a wooden plate) of the ASSY MAIN BD DX.

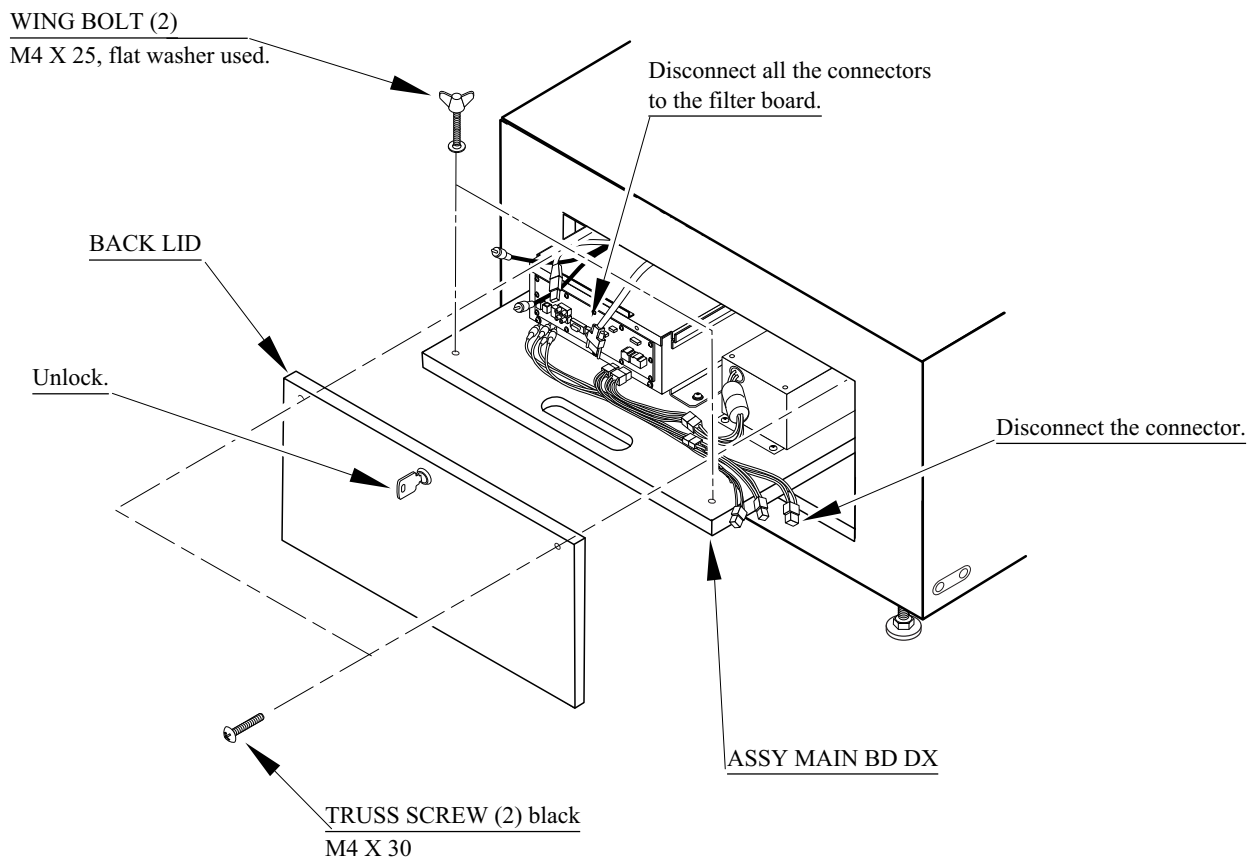

FIG. 17. 1 a

- ⑥ Draw out the ASSY MAIN BD DX from the main cabinet. More than two workers must engage in this action. Note that the ASSY MAIN BD DX is heavy, and, if a single worker draws out it alone, he/she may damage the wires by snagging or catching the wires on other parts.

NOTE: If you remove the 3 screws and detach the shield case lid, you can access to the game board. This action is allowed, however, only for the Sega's service engineer.

- ⑦ Remove the 4 screws that fix the shield case onto the base (a wooden plate), and detach the former from the latter.

- ⑧ Remove the 2 screws each, and detach the shield case from the shield case brackets. Wrap the shield case with protective shipping materials, and contain it in a carton box. Send it for repairing.

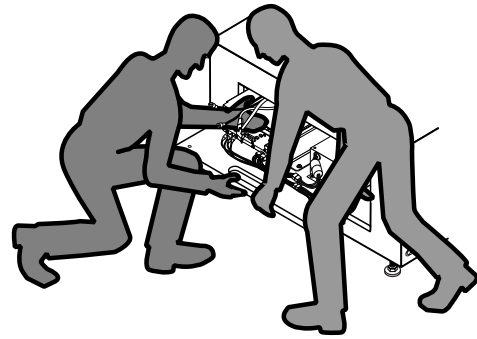

To perform work safely,
use 2 or more workers.

FIG. 17. 1 b

18. COMMUNICATION PLAY

For this game, up to 8 machines can be connected to allow up to 8 players to play simultaneously. In this instance, connecting the communication cable and setting for the communication play required.

18 - 1 INSTALLATION PRECAUTIONS

- Before starting to work, ensure that the Power SW is OFF. Failure to observe this can cause electric shock or short circuit.
- Use care so as not to damage wirings. Damaged wiring can cause electric shock or short circuit.
- Do not touch undesignated places. Touching places not designated can cause electric shock or short circuit.
- This work should be performed by the Location's Maintenance Man or Serviceman. Performing work by non-technical personnel can cause electric shock hazard.
- When linking a number of machines, be sure to supply sufficient power for the corresponding number of machines. Be sure to secure per machine current as stated in this manual. Failure to observe this can cause a fire and an electric shock accident.
- Due to the length of the communication cable, the distance in between the machines is limited. However, to avoid accidents, be sure to secure space in excess of 70 cm between the machines.
- In order to avoid personal injury, when separating the machine into each CABI, pay attention so as not to cause the PTV to fall down.
- To perform work safely and avoid serious accident such as the cabinet's falling down, do not perform work in places where step-like grade differences, a ditch, or slope exist.

To perform work safely, be sure to secure the space corresponding to number of machines to be linked. Failure to observe this can cause an accident.



IMPORTANT

The optic fiber cable is used for the communication linkage. Excessive bending may damage the communication cable. Be very careful in this regard.

Since 2 or more machines are to be linked, sufficient power corresponding to the number of machines used need to be supplied. Note that as a standard, the per machine capacity should be 15A for the 100 ~ 120V area, and 7A for the 220 ~ 240V area.

DISTANCE BETWEEN MACHINES

Be sure to secure space in excess of 70cm between machines.

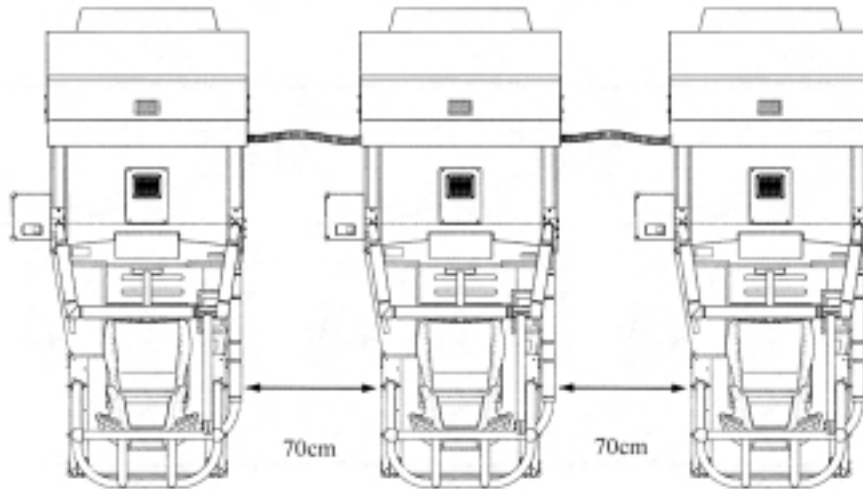

FIG. 19.1

18 - 2 CONNECTING THE COMMUNICATION CABLE

To enable the game machines to serve in a communication play, you must interconnect their game boards with communication cables (optical fiber cables).

As for a wiring of the communication cables within the main cabinet (between the game board and the connector plate), Sega has completed it before it before shipping. Each connector plate has two connectors. Use them to wire the communication cables between one game machine to the next; thereby you can interconnect all the game boards. For this wiring, prepare in advance some standard accessories: flexible tube, 2 of 22, communication cable, and 2 sets fo number sticker.

- ① Turn off power and disconnect the plug. From the viewpoint of protecting, disconnect the power cord.
- ② Referring to Chapter 6, uncouple the main cabinet from the PTV base/PTV/billboard. Be careful not to damage the wires between them.
Also be careful not to carelessly push the PTV base/PTV/billboard because it is easy to fall to the ground.
- ③ Remove the 4 trusshead screws to detach the connector box from the main cabinet.

TRUSS SCREW (4) black M4 X 16

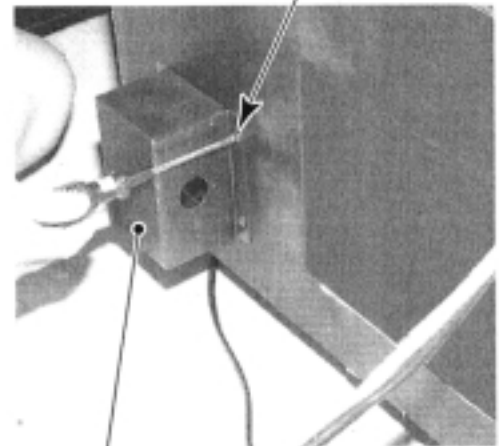

CONNECTOR BOX

PHOTO 18.2

- ④ Remove the 2 screws to detach the hole lid from the connector box. Depending on the number and arrangement of the interconnected game machines, you may remove either or both of the 2 hole lids. (Fig. 18.2a)

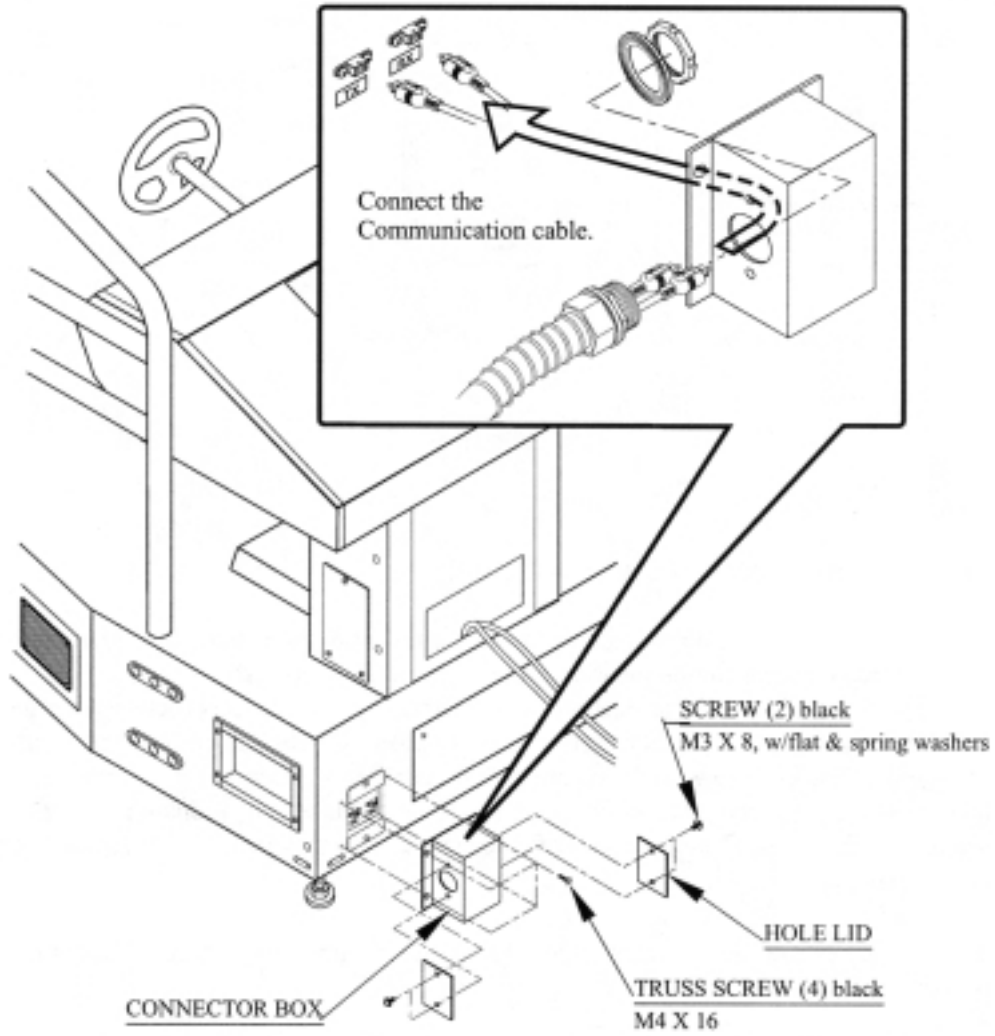

FIG. 18. 2 a

- ⑤ Attach CONNECTOR 22 to the both ends of FLEX TUBE. First, disassemble CONNECTOR 22 (Fig. 18.2 b).
- ⑥ First pass the plastic nut through the flex tube. Otherwise, the following work can not be performed and therefore, be very careful of this point.
- ⑦ Install the holder and then the “insert” to the end of the flex tube by turning them as in bolts and nuts (Fig. 18.2 c).
- ⑧ Tighten the plastic nut to the connector. At this time, pass the communication cable through the flex tube ahead of time so as to allow the following work to be performed easily (Fig. 18.2 d).
- ⑨ Install the flex tube into the CONNECTOR BOX HOLE. Insert the connector into the CONNECTOR BOX HOLE, put the seal washer through and fasten the metal nut (Fig. 18.2 e).

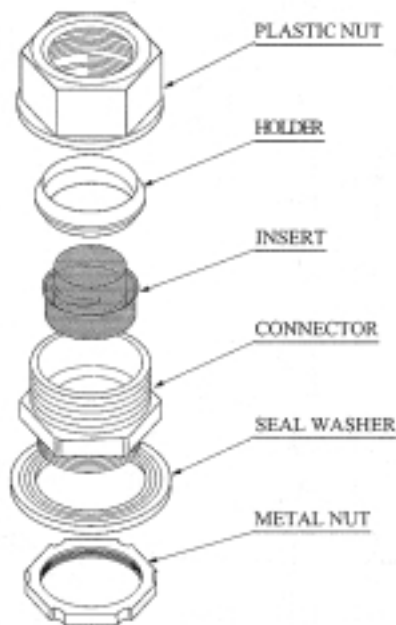

FIG. 18.2 b



FIG. 18.2 c



FIG. 18.2 d

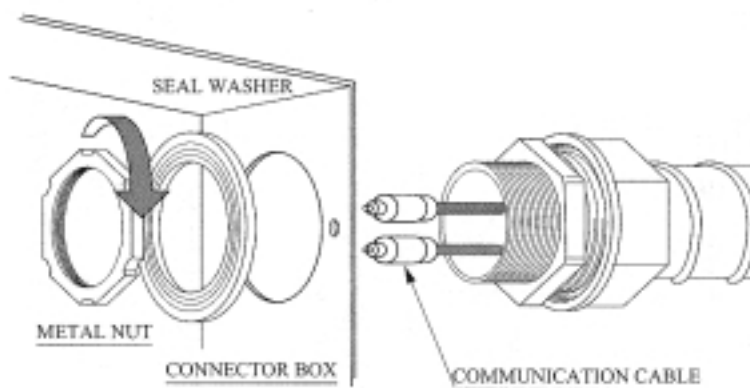

FIG. 18.2 e

- ⑩ Wire the communication cables. A wiring method (connecting which connector to which connector) varies depending on the number of the game machines to interconnect. Wire exactly according to the illustration below. For the number other than in the illustration, always connect the TX on one game machine to the RX of the other, and thereby make a loop of the communication cable finally. (Fig. 18.2 f)

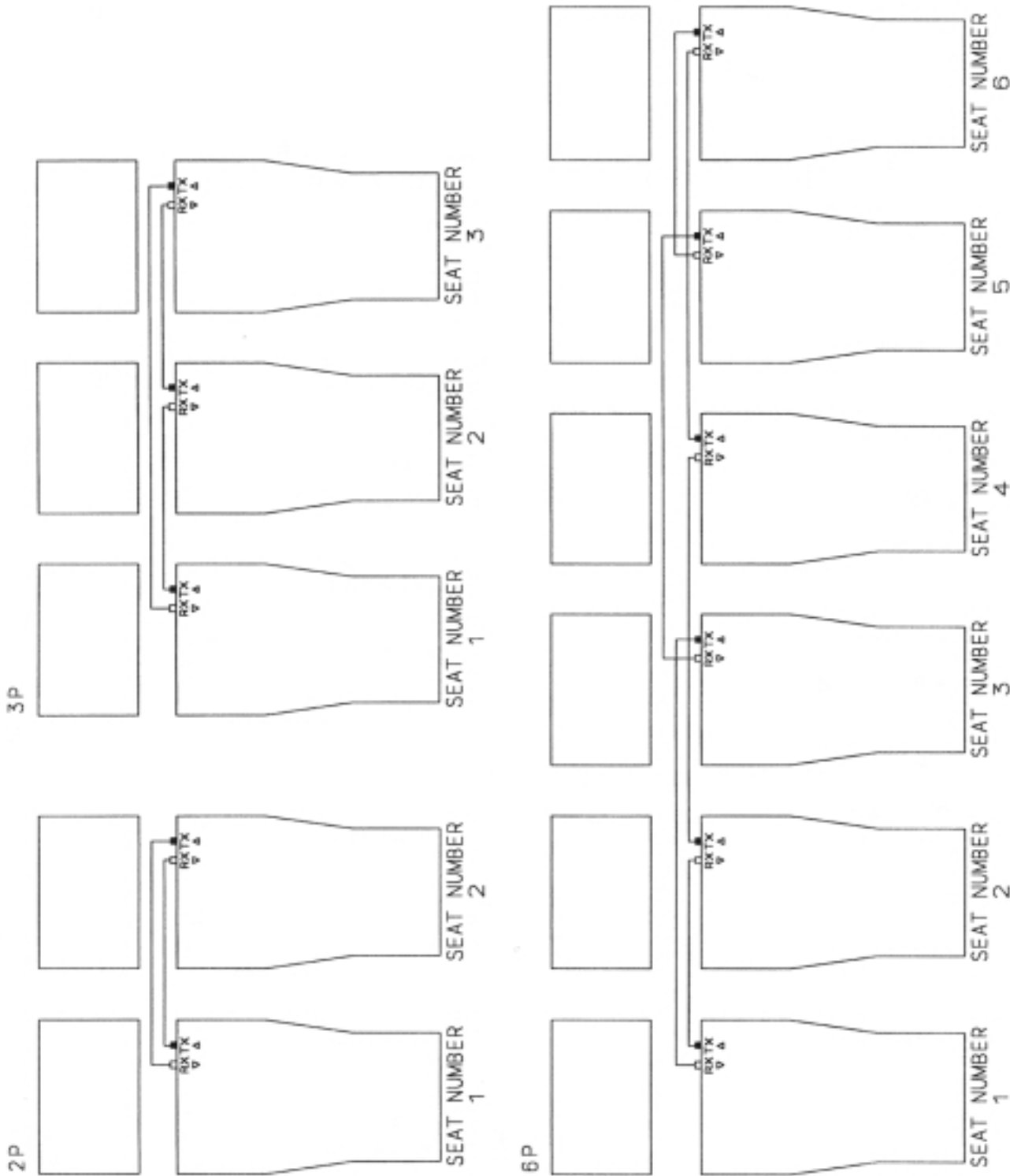

FIG. 18.2 f

- ⑪ Fix the connector box onto the main cabinet. Use the 4 trusshead screws that you removed previously.
- ⑫ Re-couple the main cabinet and the PTV base/PTV/billboard with each other.
- ⑬ Arrange the game machines. See Chapter 7 for the precautions in transportation. Keep a space between the game machines as wide as possible.
- ⑭ Contact the adjusters of all the game machines to the floor. (Sec. 6.3)
- ⑮ Connect the power cords and the grounding cables. (Sec. 6.4)
- ⑯ Put the number stickers on the game machines. Facing the PTV screens, put the stickers '1' '2' '3' ... on the game machines from left to right. (Fig. 18. 2g)



During communication play, if the test mode is not finished within 3 minutes on all the linked machines, the NETWORK CHECK cannot be performed, causing NETWORK ERROR.

Change the game setting for each seat in a manner so as to meet communication play. If the setting is not correct, communication play cannot be played.

SETTING FOR COMMUNICATION PLAY

- ① Turn the linked machines' power on.
- ② Cause all of the machines to enter the test mode.
- ③ Select the SYSTEM ASSIGNMENTS.
- ④ Perform the COMMUNICATION MODE setting in the SYSTEM ASSIGNMENTS screen. Set one of the machines to MASTER and all others to SLAVE. Set to RELAY for exclusive use of LIVE Monitor.

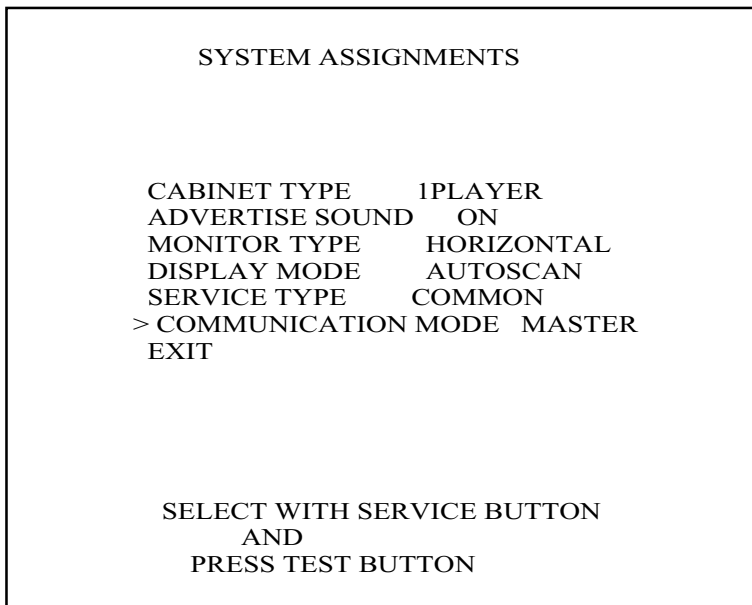

FIG. 18. 3 a

- ⑤ Activate the game test mode. (9-3)
- ⑥ Select and open the GAME ASSIGNMENTS screen. Note that the screen looks different between the MASTER and SLAVE game machines.
- ⑦ Perform the SEAT NUMBER setting in the GAME ASSIGNMENTS screen. Set the machines sequentially to No.1, No.2, No.3, and so on as applicable starting from the extreme left facing the monitor's front side. Set every seat number correctly without duplication.

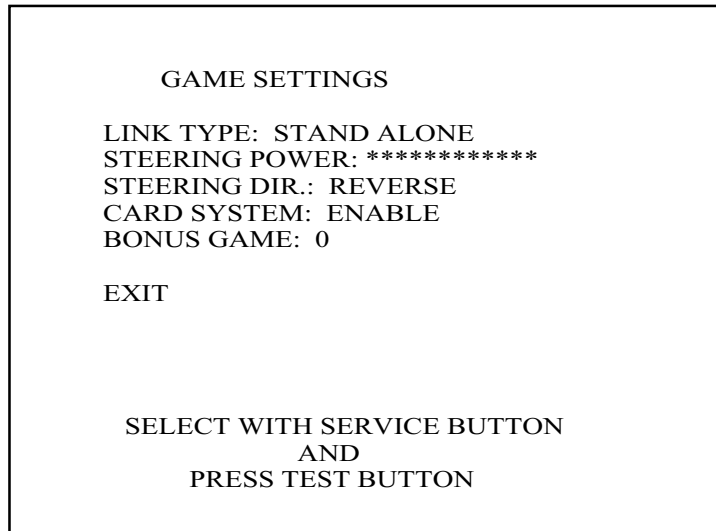

FIG. 19. 3 b

Cause all of the machines to exit from the test mode. After the test mode, the screens proceed to and display the NETWORK CHECK.

When a network-checking is finished, the system displays an advertisement screen. This means a successful completion of setting. If any seat number is duplicated, an error message appears on the screen. Normally the NETWORK CHECK takes less than one minute. If the screen does not proceed from the NETWORK CHECK screen, some sorts of errors such as incorrect setting, or incorrect connection or malfunctioning of the communication cable can be considered.

19 - 4 CAUTIONS TO BE HEEDED DURING COMMUNICATION PLAY



- With a communication play, the ADVERTISE SOUND and GAME DIFFICULTY items can be set only on the MASTER game machine. New settings by the MASTER game machine become effective to all the interconnected game machines.
- If any setting is inadequate or if the communication cables are improperly connected, the system keeps displaying the network-checking screen or an error message. If this is the case, you cannot play the game.
- During communication play, if communication is interrupted due to some cause, the game is discontinued and the NETWORK CHECK screen is displayed.
- If one of the linked machines enters the test mode, all others display the NETWORK CHECK screen.

Machine's operation when linked for communication play alters comparing to that of when independently operated. Be careful of this point.

As described above, some setting items must be set only on the MASTER game machine. They cannot be set on any SLAVE game machines or, if set, will not become effective.

When any game machine is in a test mode, a network-checking screen appears on the other game machines interconnected for a communication play. While a guest is using any one of the interconnected game machines, therefore, do not activate a test mode even on the unused game machine.

19. DESIGN RELATED PARTS

For the Warning Display stickers, refer to Section 1.

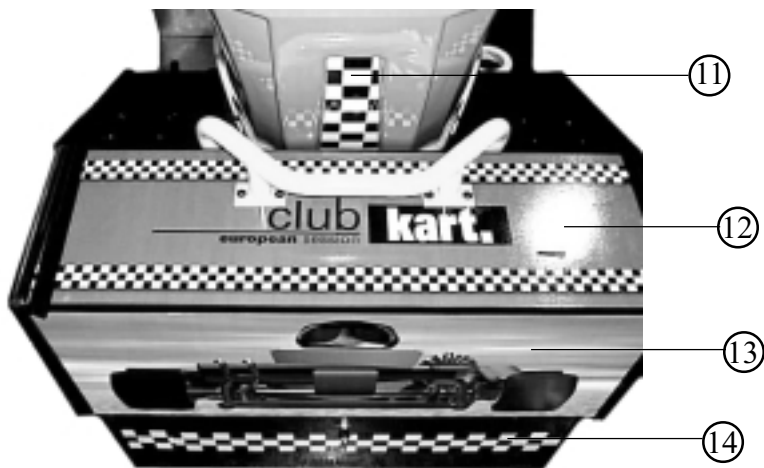
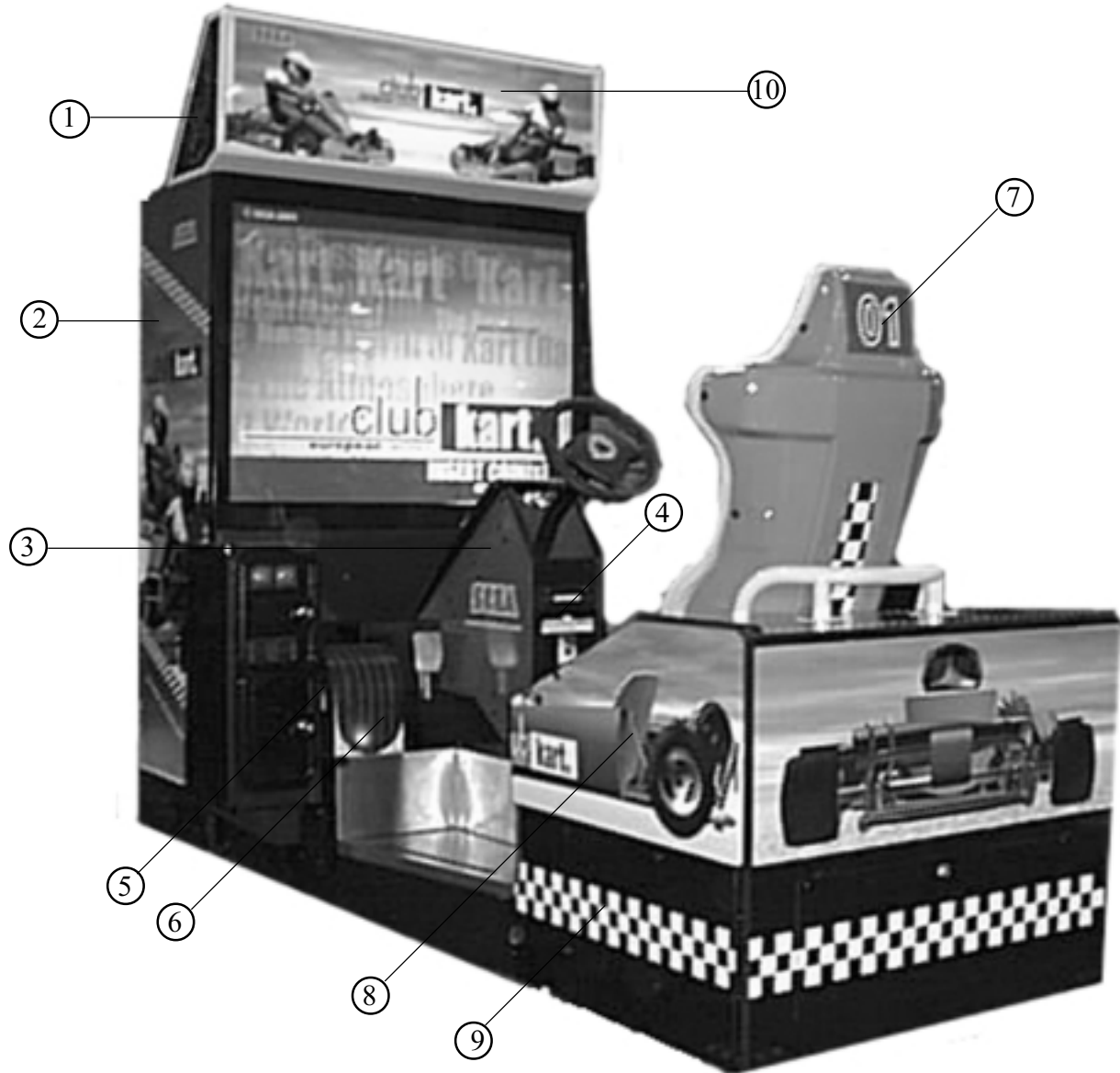

ITEM NO.	PART NO.	DESCRIPTION
1	999-1252	DECAL MARQUEE SIDE LEFT
NOT SHOWN	999-1253	DECAL MARQUEE SIDE RIGHT
2	999-1237	DECAL SIDE LEFT MONITOR
NOT SHOWN	999-1236	DECAL SIDE RIGHT MONITOR
3	999-1241	DECAL PEDESTAL LEFT
NOT SHOWN	999-1242	DECAL PEDESTAL RIGHT
NOT SHOWN	999-1240	DECAL PEDESTAL TOP
4	999-1254	DECAL INSERT CLUB CARD (INSTR. #1)
5	999-1238-L	DECAL LEFT TIRE BOX
NOT SHOWN	999-1238-R	DECAL RIGHT TIRE BOX
6	999-1239	DECAL LEFT, RIGHT TIRE TREAD
7	999-1250	DECAL NUMBER SHEET 1-8 SEAT (2 PER)
8	999-1244	DECAL REAR SECTION LEFT
NOT SHOWN	999-1243	DECAL REAR SECTION RIGHT
9	999-1248	DECAL CHECKERBOARD LEFT
NOT SHOWN	999-1249	DECAL CHECKERBOARD RIGHT
10	999-1235	MARQUEE CKT DLX
11	999-1251	DECAL REAR SEAT
12	999-1245	DECAL REAR SECTION TOP
13	999-1246	DECAL REAR SECTION BACK
14	999-1247	DECAL CHECKERBOARD REAR PANEL TOP
NOT SHOWN	999-1255	DECAL INSTRUCTIONS #2 (COIN TOWER)
NOT SHOWN	999-1256	DECAL NUMBER SHEET 1-8 PEDESTAL (2 PER)

20. PARTS LIST

① TOP ASSY

(D-1/1)

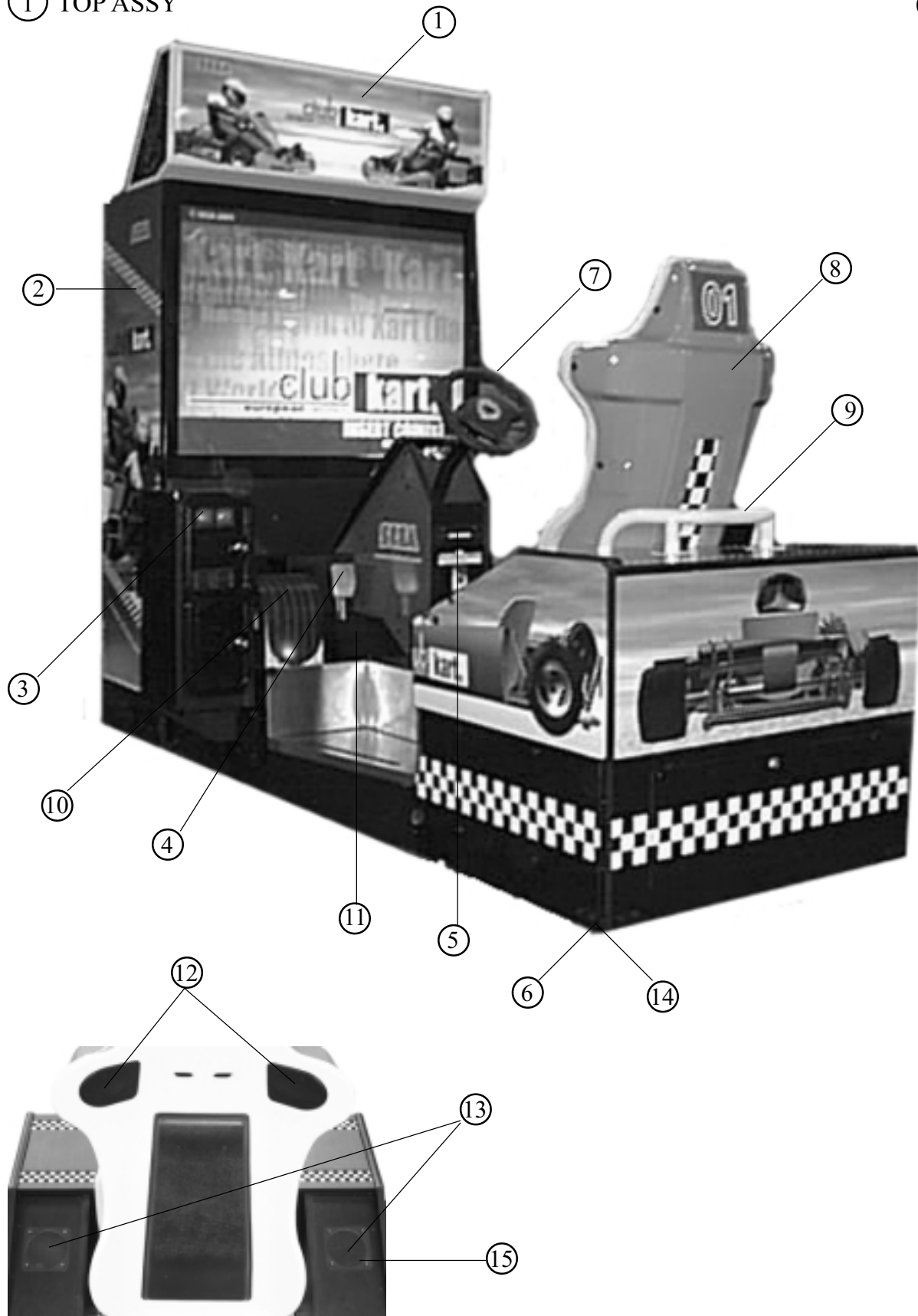

① TOP ASSY

(D-2/2)

ITEM NO.	PART NO.	DESCRIPTION
1	LOC. PURCHASE	FLUORESCENT FIXTURE 30 WATTS 36"
2	N/A	50" PTV
3	N/A	COIN METER
4	SPG5-2200-B	BRAKE PEDAL
NOT SHOWN	SPG5-2200-A	ACCELERATOR PEDAL
5	999-1258	CARD READER ASSY
6	999-0167	LEG LEVELER 1/2-13 X 3" (6 PER)
7	SPG-2001	STEERING WHEEL
8	999-1257	REAR SEAT COVER (GREEN)
9	999-1262	S/A; TUBE - BUTTERCUP YELLOW
10	N/A	TIRE BOX LEFT, RIGHT
11	999-1260	ASSY FOOT PEDAL PLATE LEFT (METAL)
NOT SHOWN	999-1273	ASSY FOOT PEDAL PLATE RIGHT (METAL)
NOT SHOWN	999-1274	ASSY FOOT PEDAL PLATE REAR (2) (METAL)
12	130-5162	GULL BOX SPEAKER 80 OHM 8W
13	130-5206	SPEAKER 16CM 4 OHM 25W (2 PER)
14	999-0169	CASTER 160-2 1/2 #25188 SWIVEL (6 PER)
15	999-1220	SPEAKER GRILL (2 PER)

② ASSY PTV (NCR-0500)

(D-1/2)

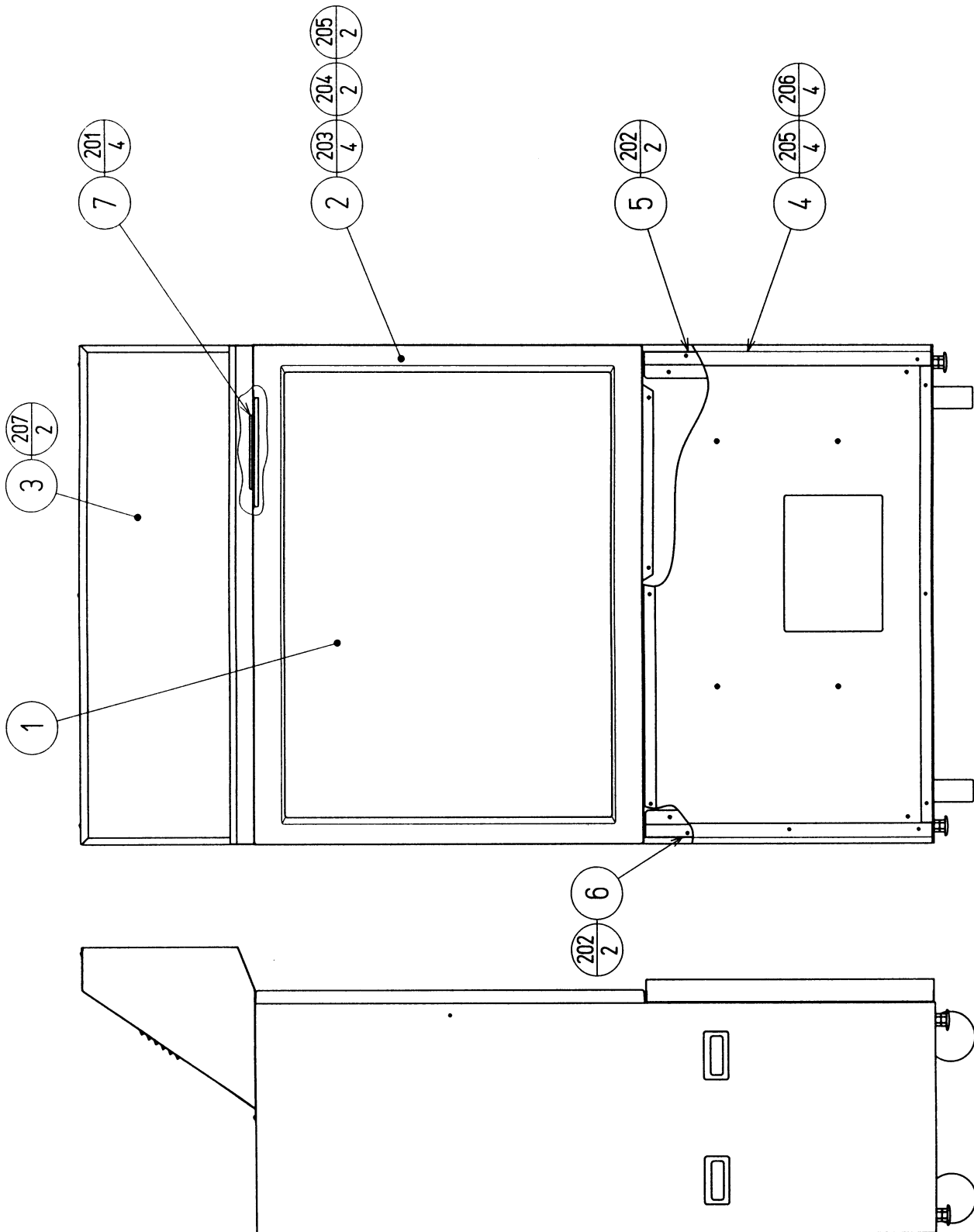

② ASSY PTV (NCR-0500)

(D-2/2)

ITEM NO.	PART NO.	DESCRIPTION
1	N/A	PTV W/STICKER
2	MGL-1150	ASSY MASK
3	N/A	ASSY BILLBOARD
4	NCR-0600	ASSY FRONT PANEL
5	DYN-0501	PANEL MOUNT BRKT L
6	DYN-0502	PANEL MOUNT BRKT R
7	RAL-0501	MASK HOLDER
201	000-F00412	M SCR FH M4 X 12
202	000-P00516-W	M SCR PH W/FS M5 X 16
203	000-P00520-W	M SCR PH W/FS M5 X 20
205	000-T00525-0B	M SCR TH BLK M5 X 25
206	068-552016-0B	FLT WSHR BLK 5.5-20 X 1.6
207	000-T00520-0B	M SCR TH BLK M5 X 20
208	000-P00516-WB	M SCR PH W/FS BLK M5 X 16

3 ASSY BILLBOARD

(D-1/2)

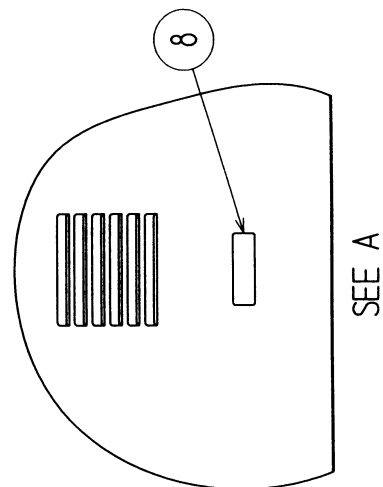
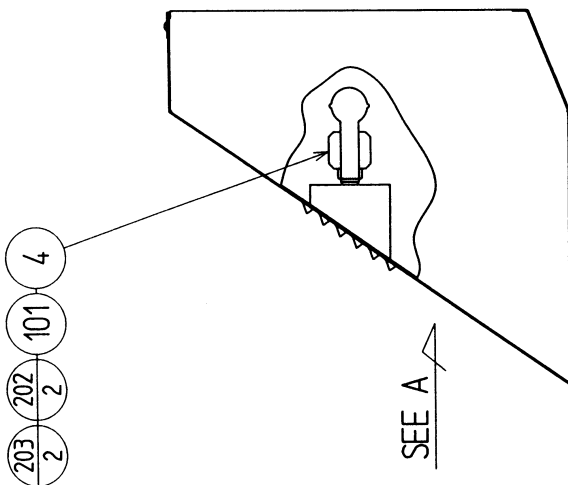
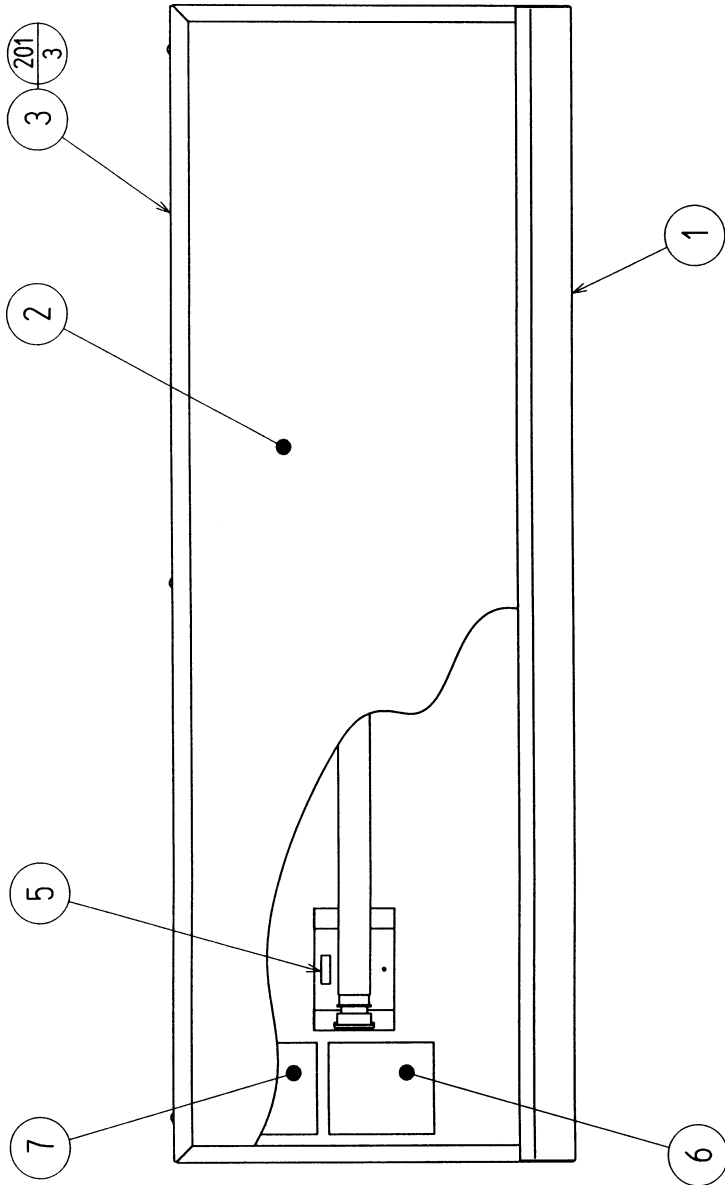

③ ASSY BILLBOARD

(D-2/2)

ITEM NO.	PART NO.	DESCRIPTION	NOTE
1	NCR-0551	BILLBOARD BOX	
2	999-1235	MARQUEE CKT DLX	
3	NCR-0552	BILLBOARD SASH	
4	253-5457	FL HOLDER Locally supplied.	OTHERS USA
5	421-7501-18	STICKER FL32W Locally supplied.	OTHERS USA
6	440-WS0002XEG	STICKER W POWER OFF ENG	
7	440-WS0012XEG	STICKER W HIGH TEMP ENG	
101	390-6659-32EX	ASSY FL32W EX W/CONN HIGH S CE Locally supplied.	OTHERS USA
102	280-5275-SR10	CORD CLAMP SR10	
201	000-T00408-0C	M SCR TH CRM M4 X 8	
202	000-P00430-S	M SCR PH W/S M4 X 30 Locally supplied.	OTHERS USA
203	068-441616	FLT WSHR 4.4-16 X 1.6 Locally supplied.	OTHERS USA

④ ASSY FRONT PANEL (NCR-0600)

(D-1/2)

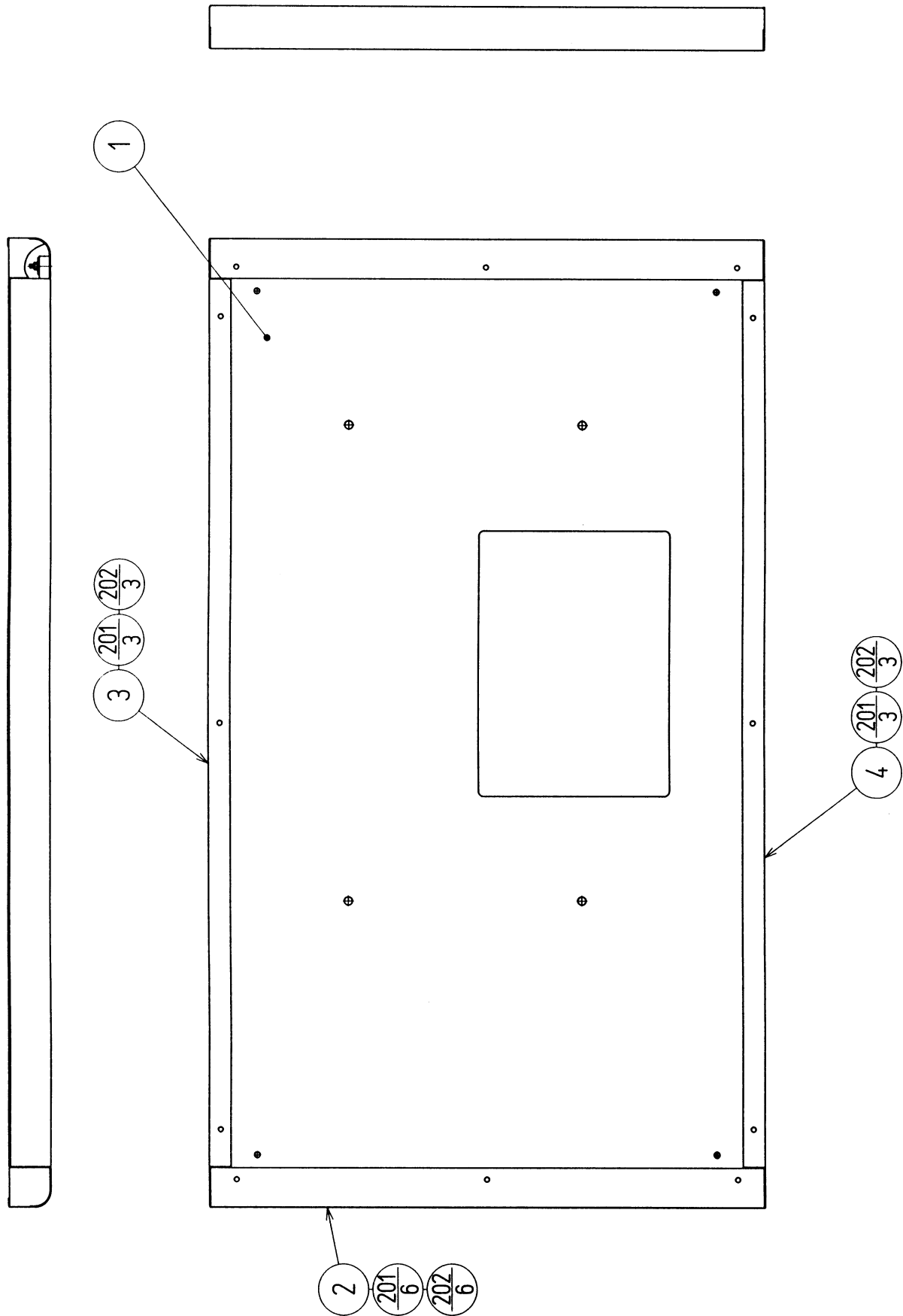

④ ASSY FRONT PANEL (NCR-0600)

(D-2/2)

ITEM NO.	PART NO.	DESCRIPTION
1	NCR-0601	FRONT PANEL
2	EZT-0603	SIDE BRKT
3	EZT-0604	BRKT UPPER
4	EZT-0605	BRKT LOWER
201	068-552016	FLT WSHR 5.5-20 X 1.6
202	050-F00500	FLG NUT M5

⑤ ASSY MASK (MGL-1150)

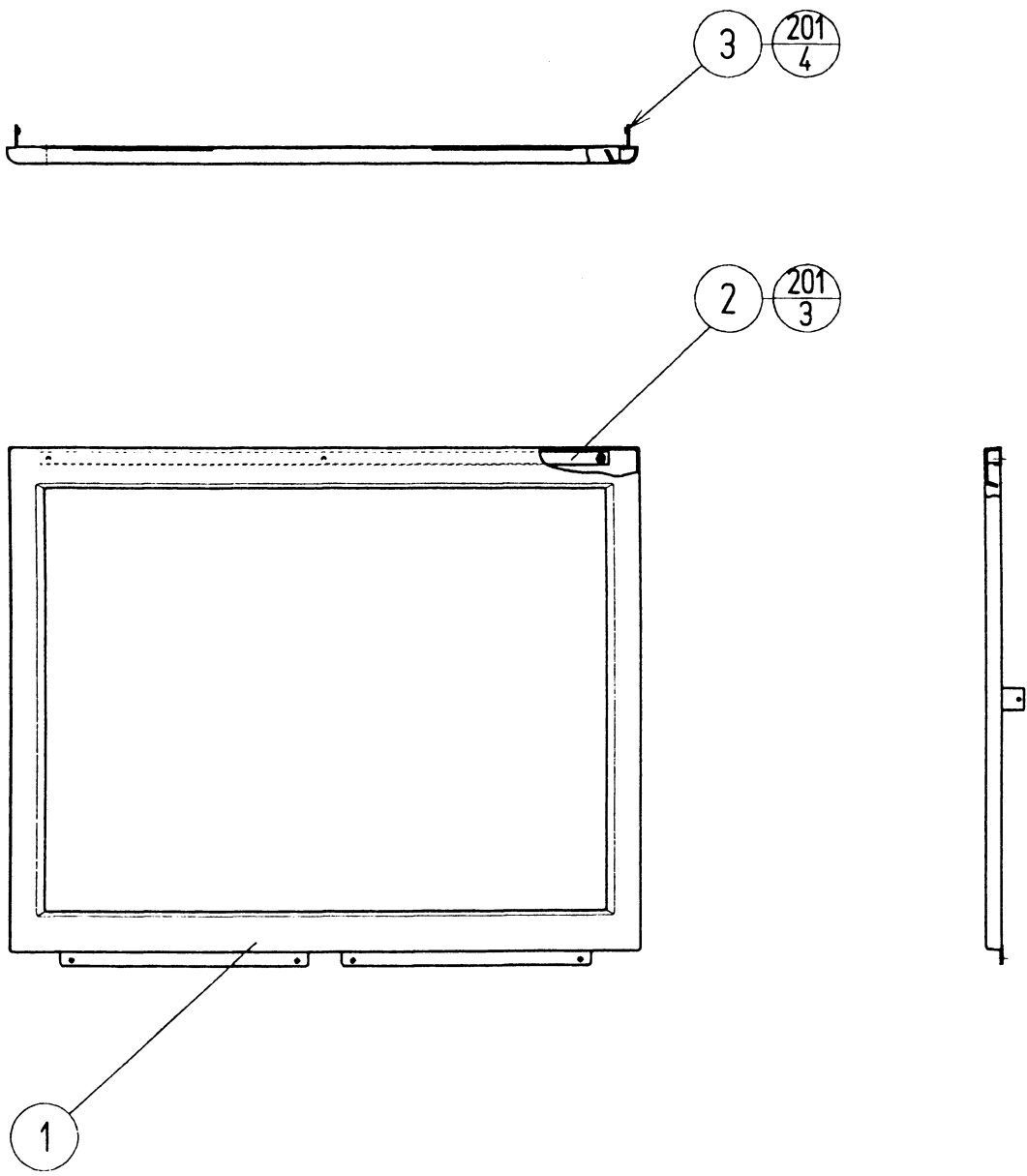

ITEM NO.	PART NO.	DESCRIPTION
1	MGL-1102	TV MASK
2	MGL-1151	SLIT PLATE
3	MGL-1152	MASK SIDE HOLDER
201	012-F00408-0B	TAP SCR #2 FH BLK 4 X 8
202	000-F00410	M SCR FH M4 X 10

⑥ PTV W/STICKER NCR (NCR-0510)

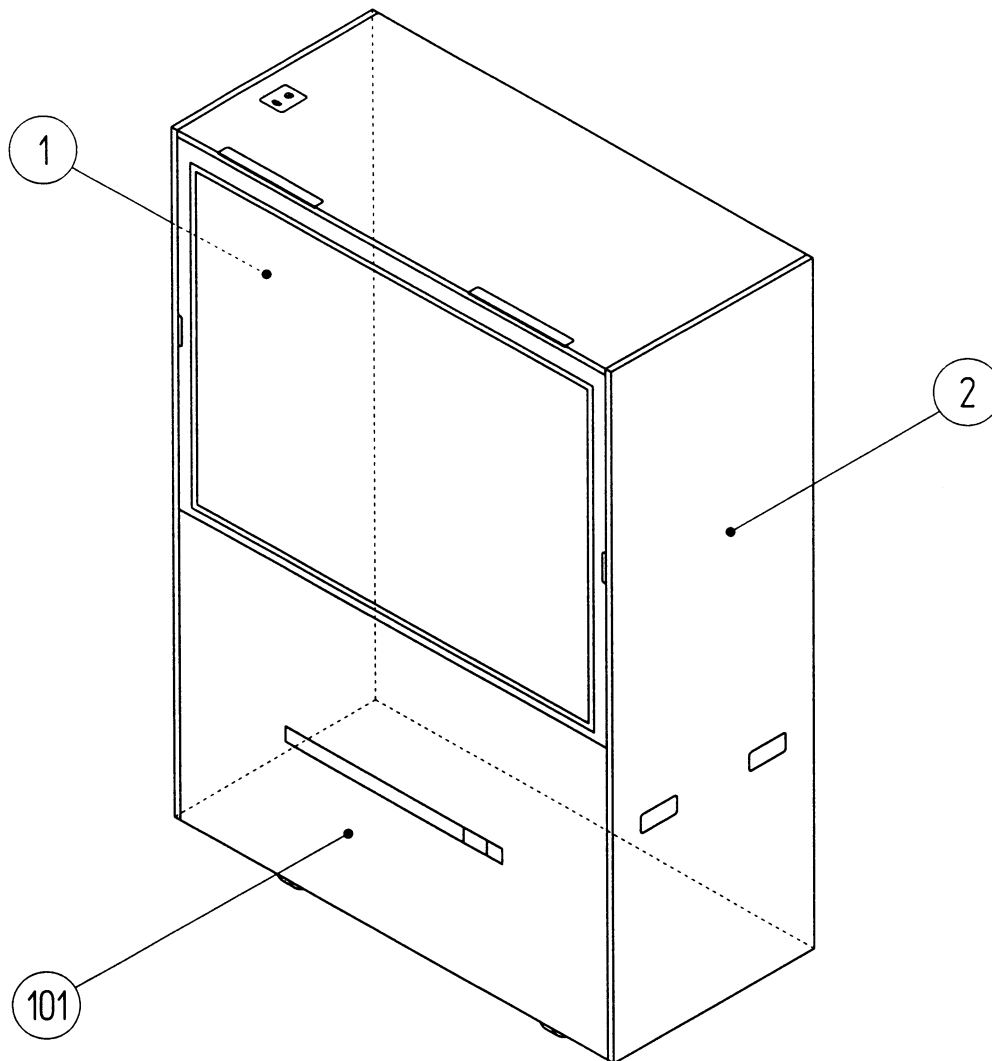

ITEM NO.	PART NO.	DESCRIPTION
1	999-1237	STICKER PTV SIDE L
2	999-1236	STICKER PTV SIDE R
101	200-5788-31	PROJECTION DSPL T 50TYPE 31K

7 ASSY PTV BASE (POD-0550)

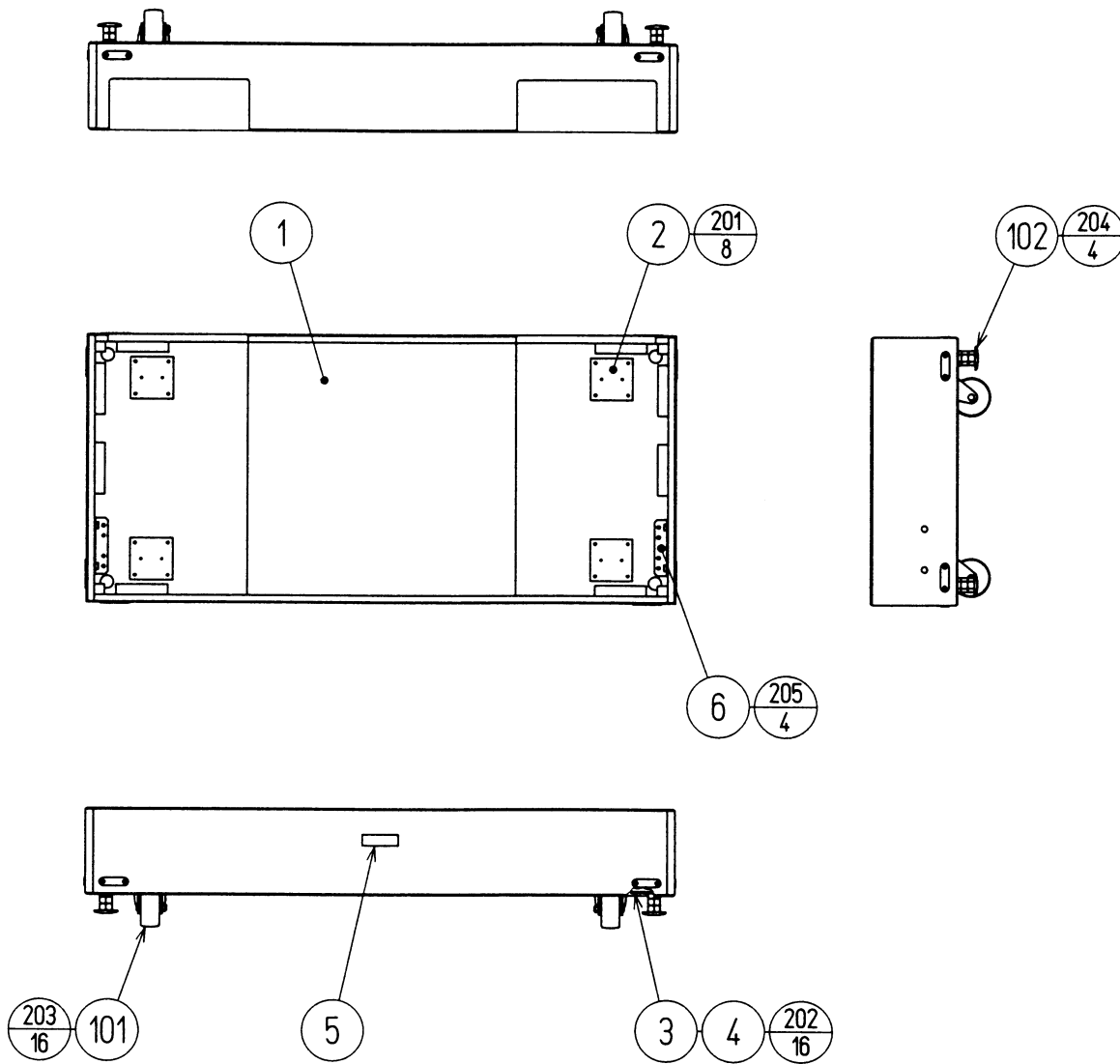

ITEM NO.	PART NO.	DESCRIPTION
1	POD-0551	PTV BASE
2	SCR-1008	NUT PLATE FOR CASTER
3	ARC-1006	LEG BRACKET
4	117-5233	PLATE LEG BRACKET BLACK
6	POD-1008	NUT BRKT
101	999-0169	CASTER 160-2 1/2"
102	999-0167	LEG ADJUSTER BOLT 1/2-13 X 3"
201	011-T03512	TAP SCR TH 3.5 X 12
202	Loc. Purchase	HEX BLT W/S BLK M6 X 25
203	Loc. Purchase	HEX BLT W/FS M6 X 25
204	Loc. Purchase	HEX NUT BLK M16
205	000-P00520-W	M SCR PH W/FS M5 X 20

⑧ ASSY SUB-CABI (NCR-1001)

(D-1/2)

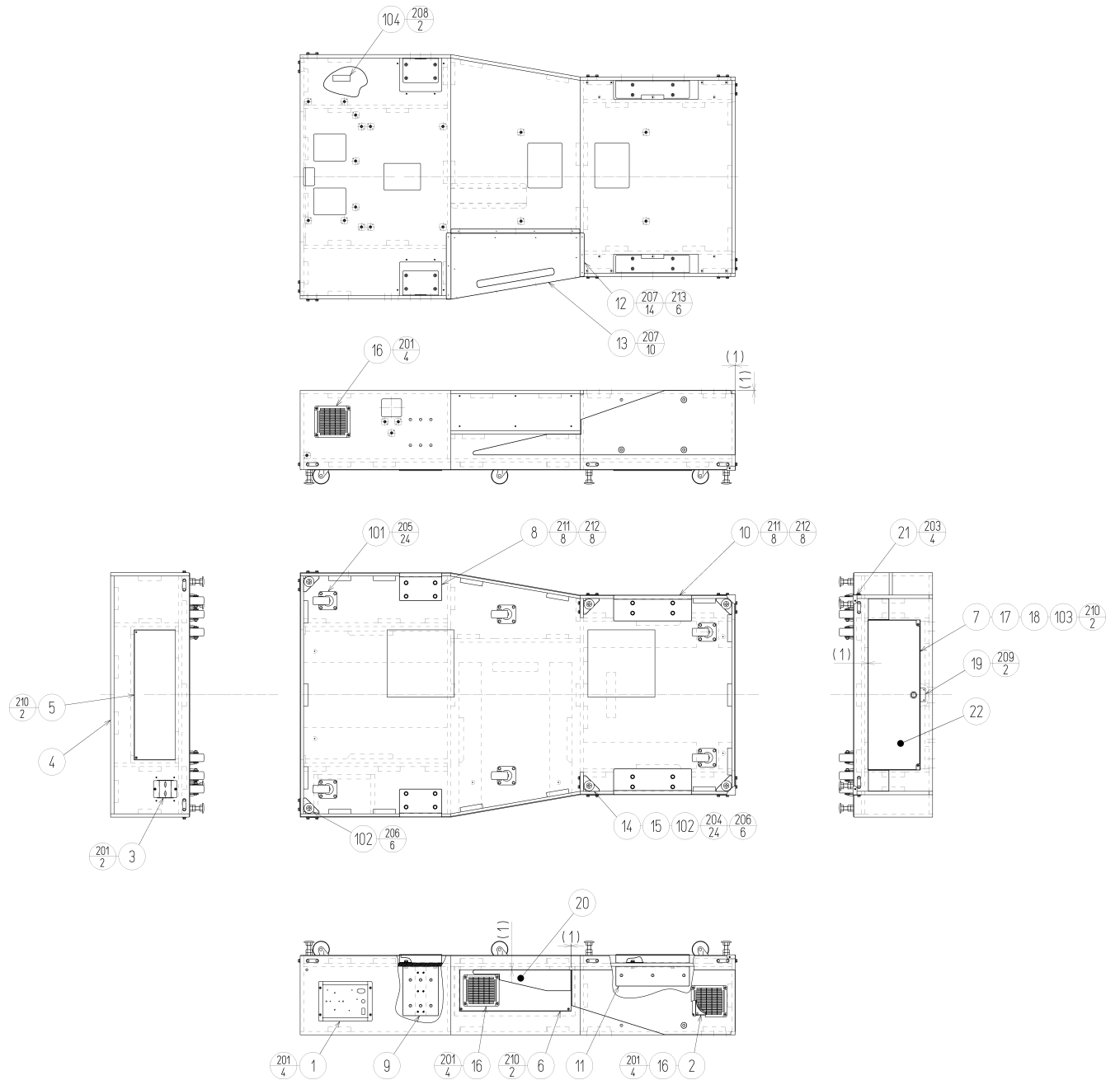

ITEM NO.	PART NO.	DESCRIPTION
1	NCR-1090	AC UNIT
2	STR-1070	FAN UNIT
3	NCR-1080	ASSY CONNECTOR PLATE
4	NCR-1002	WOODEN CABINET
5	NCR-1003	FRONT LID
6	NCR-1004	SIDE LID
7	NCR-1005	BACK LID
8	NCR-1006	SUPPORT PLATE LOWER A
9	NCR-1007	HOLD PLATE A
10	NCR-1012	SUPPORT PLATE LOWER B
11	NCR-1013	HOLD PLATE B
12	NCR-1024	STEP GUARD PLATE
13	NCR-1025	SIDE STEP PLATE
14	ARC-1006	LEG BRACKET
15	999-1042	PLATE LEG BRACKET BLACK
16	253-5460-01	AIR VENT BLACK
17	DP-1148X	LKG TNG
18	117-0062	PLATE LOCK RETAINER
19	117-5098	TNG RETAINER PLATE
20	NCR-1004-B	STICKER SIDE LID
21	APC-1090	CORNER GUARD
22	NCR-1005-B	STICKER BACK LID
101	999-0169	CASTER 160-2 1/2"
102	999-0167	LEG ADJUSTER
103	220-5575	CAM LOCK MASTER W/O KEY
104	117-5402-06-91	EARTH TERMINAL PLATE 6P
201	000-T00420-0B	M SCR TH BLK M4 X 20
203	FAS-110010	TAP SCR FH #1 BLK 3 X 10
204	030-000630-SB	HEX BLT BLK W/S M6 X 30
205	030-000625-WB	HEX BLT W/FS BLK M6 X 25
206	050-H01600	HEX NUT M16
207	079-000008	SCR NAIL THH STNLS 1.5 X 16
208	011-F03516	TAP SCR FH 3.5 X 16
209	011-T00312	TAP SCR TH 3 X 12
210	000-T00430-0B	M SCR TH BLK M4 X 30
211	030-000830-S	HEX BLT W/S M8 X 30
212	060-F00800	FLT WSHR M8
213	000-T00416-0C	M SCR TH CRM M4 X 16
301	600-6275-0300	ASSY FIBER CABLE 5 0300CM
302	600-7009-3000	ASSY RGB CA D-SUB 15P 3000MM
303	600-7141-250	CABLE JVS TYPE A-B 250CM

⑨ AC UNIT

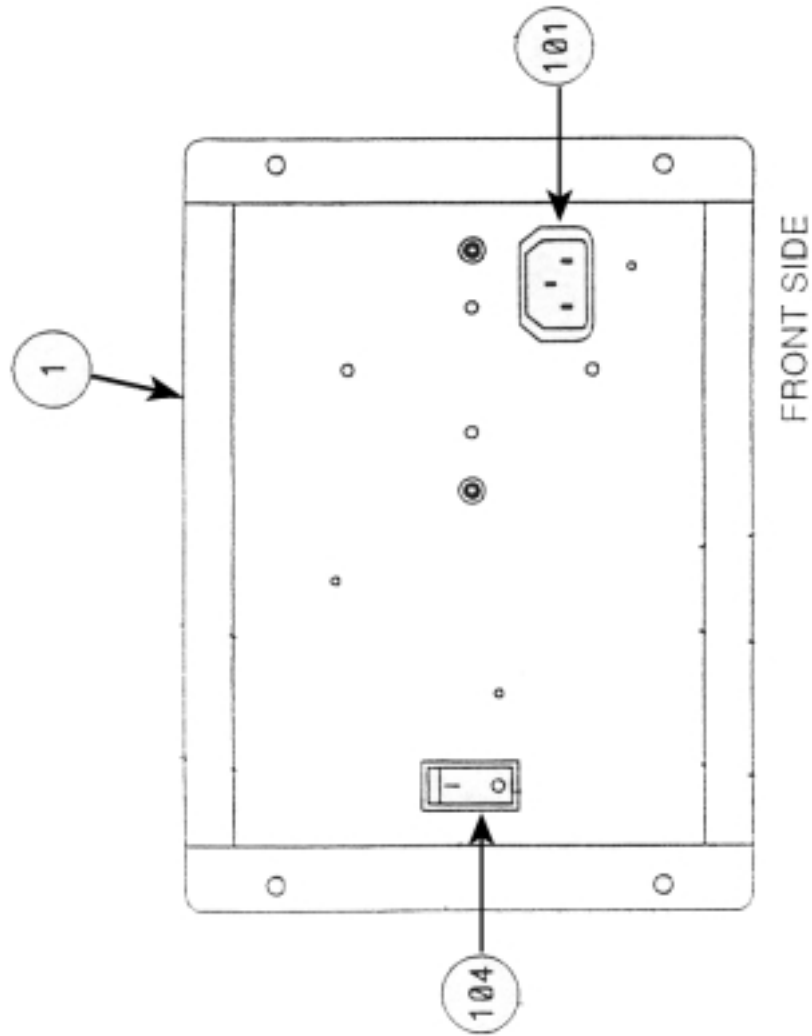

ITEM NO.	PART NO.	DESCRIPTION
1	999-1043	AC BRKT
NOT SHOWN	DYN-0402	NOISE FILTER BASE
NOT SHOWN	421-8202	STICKER EARTH MARK
101	999-1044	AC INLET PANEL TYPE
104	999-0676	SW ROCKER J8 V-B

⑩ FAN UNIT (STR-1070)

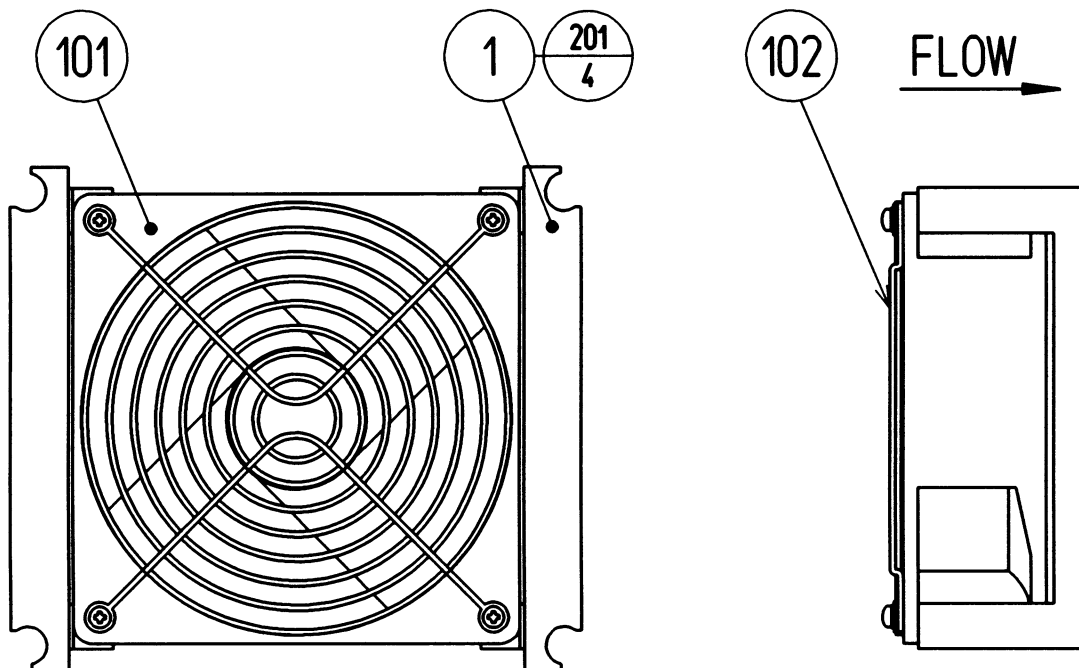
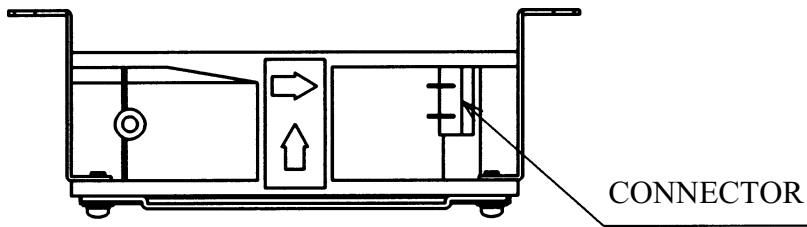

ITEM NO.	PART NO.	DESCRIPTION
1	105-5340-01	FAN BRKT LONG
101	LOC. PURCHASE	FAN AC120V
102	601-8543	FAN GUARD
201	000-P00312-W	M SCR PH W/FS M3 X 12

⑪ ASSY CONNECTOR PLATE (NCR-1080)

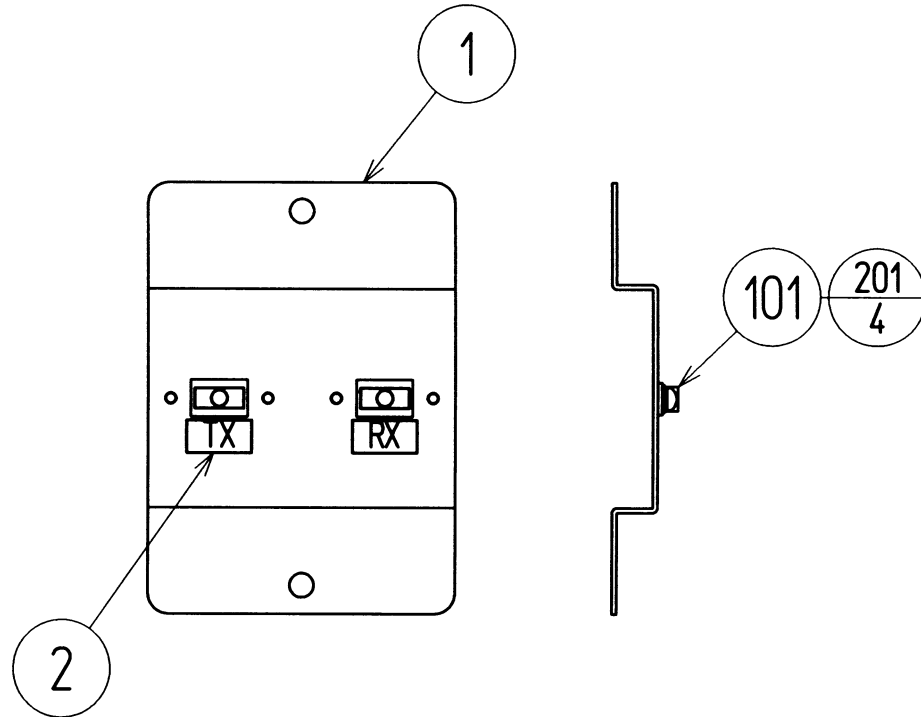

ITEM NO.	PART NO.	DESCRIPTION
1	NCR-1081	CONNECTOR PLATE
2	421-7515	STICKER FIBER CABLE TX/RX
101	211-5479-01	CONN OPT JOINT
201	000-P00312-W	M SCR PH W/FS M3 X 12

⑫ FAN UNIT (NCR-1070)

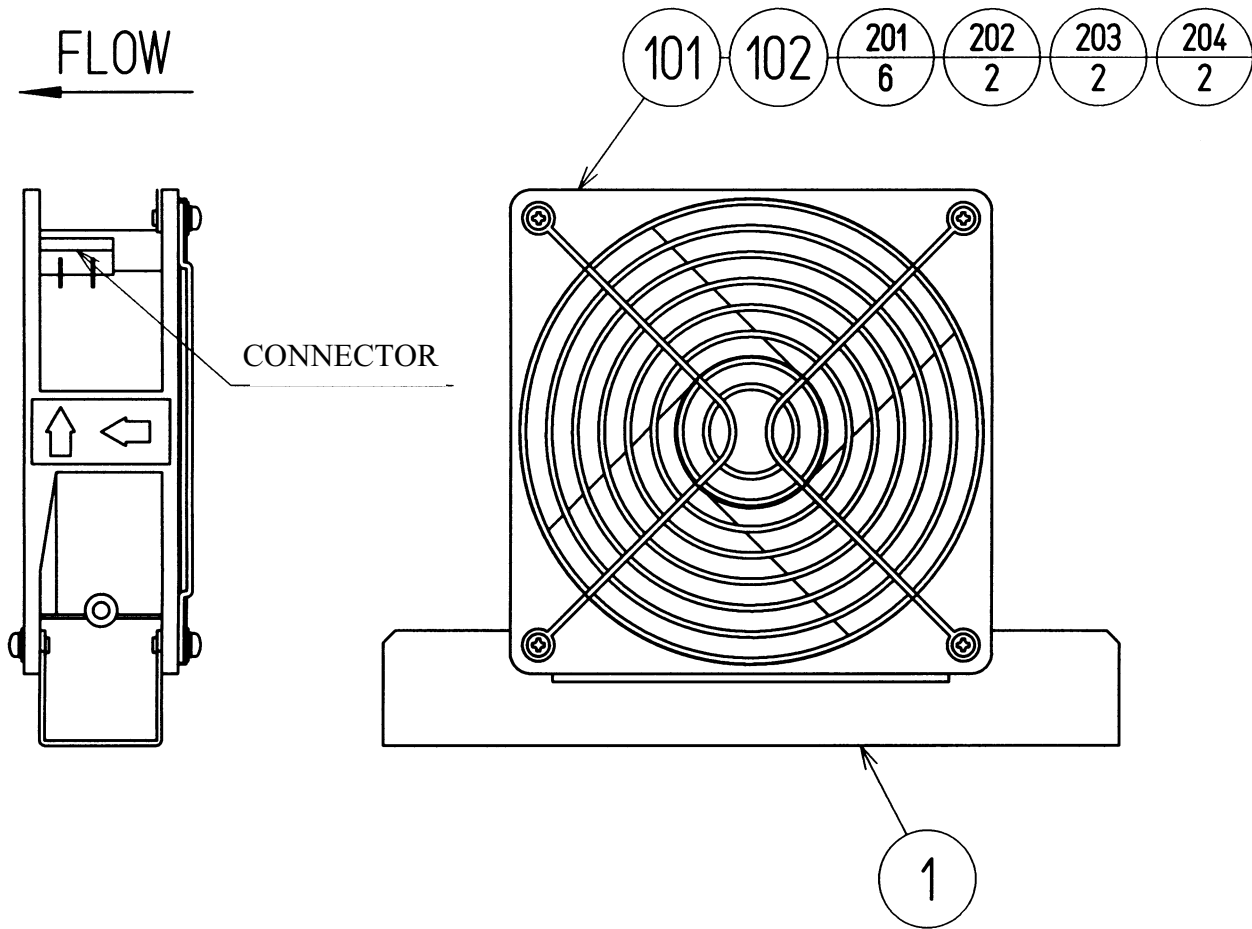

ITEM NO.	PART NO.	DESCRIPTION
1	NCR-1071	FAN BRKT
101	260-0011-02	FAN AC120V
102	601-8543	FAN GUARD
201	000-P00312-W	M SCR PH W/FS M3 X 12
202	050-H00300	HEX NUT M3
203	060-S00300	SPR WSHR M3
204	060-F00300	FLT WSHR M3

⑬ SW UNIT

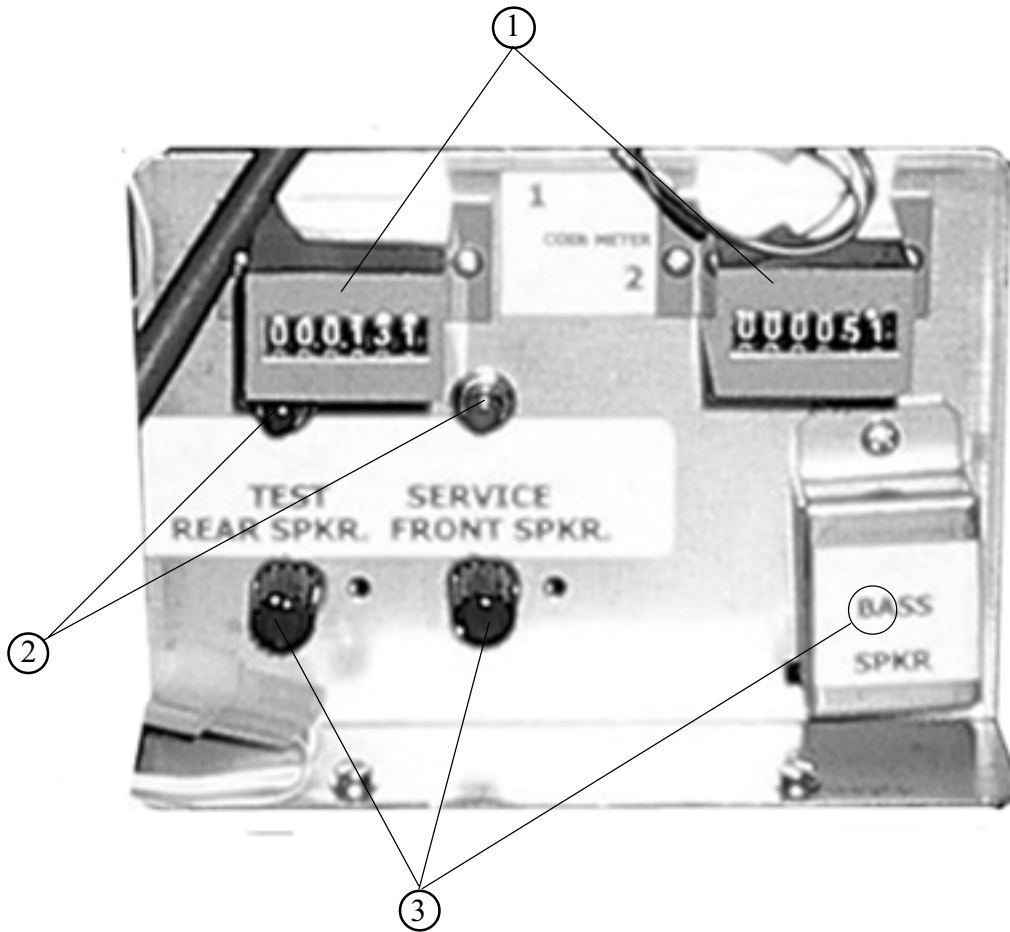

ITEM NO.	PART NO.	DESCRIPTION
1	LOC. PURCHASE	COIN METER 6 VOLTS
2	LOC. PURCHASE	PUSH BUTTON SW
3	LOC. PURCHASE	5 K POTENTIOMETER & VOLUME KNOB

⑭ ASSY CTRL PNL (NCR-2000)



ITEM NO.	PART NO.	DESCRIPTION
1	SRT-2150	ASSY SW PLATE
2	NCR-2006	STEERING COLLAR
3	SPG-2001	STEERING WHEEL
4	SPG-2002	STEERING EMBLEM

⑮ ASSY SW PLATE (SRT-2150)

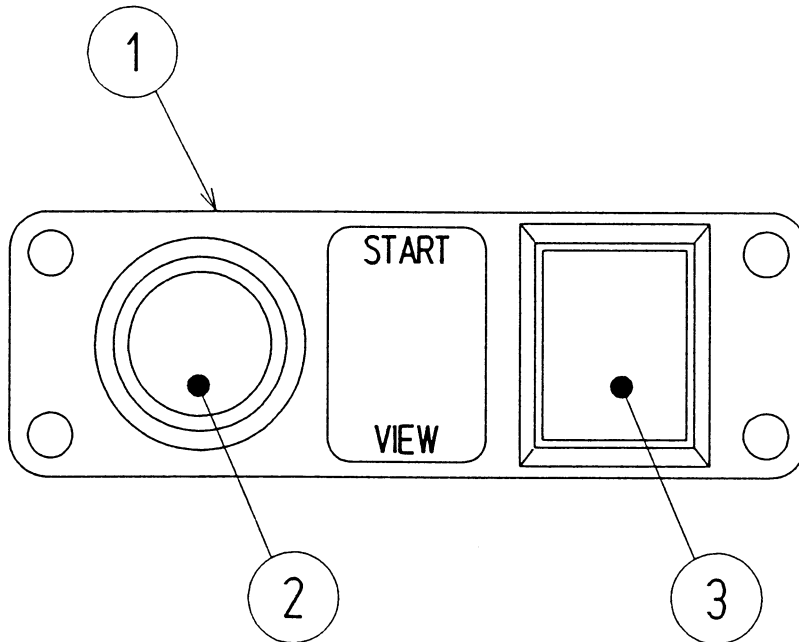

ITEM NO.	PART NO.	DESCRIPTION
1	SRT-2151	SW PLATE
101	509-5838-Y	SW PB LW1L-15Y-TK1670
102	509-5495-05	PUSH BUTTON BLUE
301	600-7008-079	WIRE HARN BUTTON

16 ASSY CTRL SHAFT

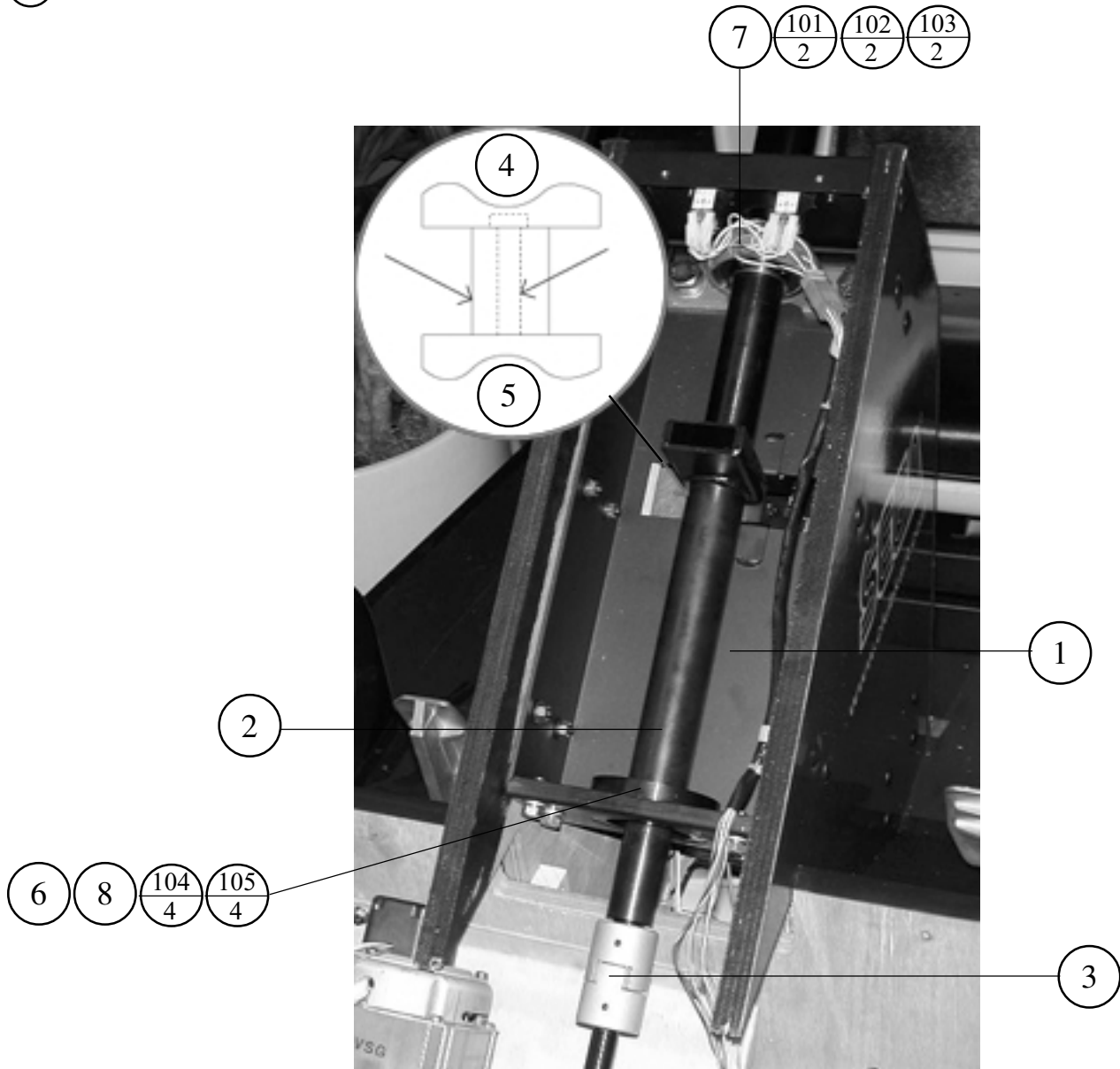

ITEM NO.	PART NO.	DESCRIPTION
1	999-1291	STEERING BASE CKT
2	NCR-2005	STEERING SHAFT
3	111-1131	COUPLING MJT-40K-BL 16-20 (FRI)
4	DUT-2106	STOPPER RUBBER
5	DUT-2105	STOPPER BOLT M10
6	NCR-2003	BEARING HOLDER
7	100-5240	BEARING FA130
8	100-5377	BEARING 30
101	030-001435	M14 X 35 HEX BOLT
102	060-S01400	SPR WASHER M14
103	060-F01400	FIT WASHER M14
104	060-F00800	M8 FIT WASHER
105	030-000820-S	M8 X 20 HEX BOLT W/S

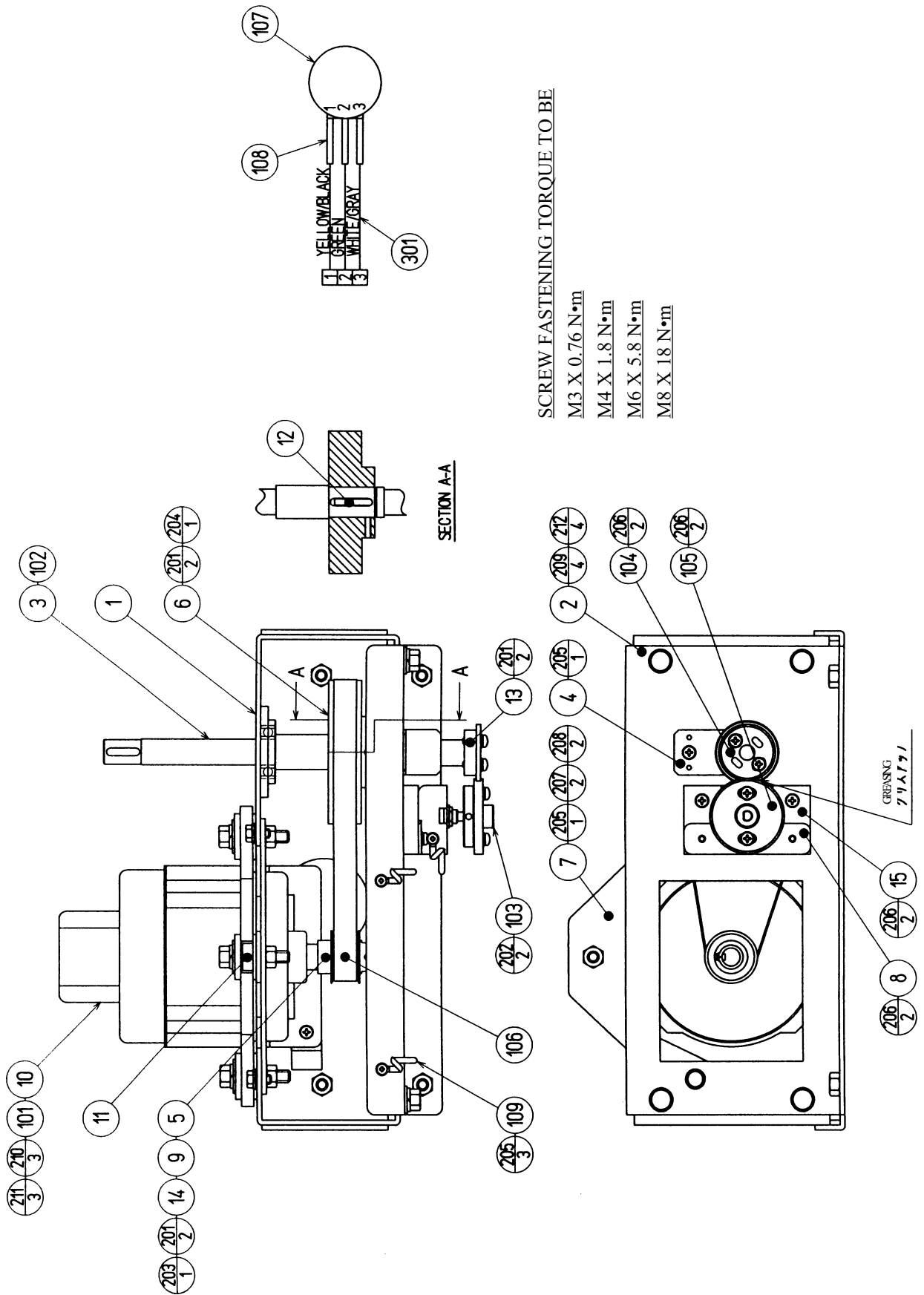

①7 STEERING MOTOR UNIT (NCR-2100)

(D-2/2)

ITEM NO.	PART NO.	DESCRIPTION
1	FRI-2101	MECHA BASE
2	FRI-2102	BASE LID
3	NCR-2101	MOTOR SHAFT
4	FRI-2104	SHAFT LOCK PLATE
5	SPG-2504	PULLEY 20 S5M
6	SPG-2505	PULLEY 60 S5M
7	SPG-2506	MOTOR BRKT
8	FRI-2105	VR BRKT
9	SPG-2453	KEY 4 X 4 X 40
10	ASK-3502	MOTOR SPACER
11	ASK-3503	MOTOR COLLAR
12	DYN-1270	STOPPER KEY
13	SLC-1130	ADJUST RING
14	SPG-2454	MOTOR SHAFT COLLAR
15	FRI-2106	VR BASE
101	350-5448-01	SERVO MOTOR 500W NEW
102	100-5112	BEARING 17
103	601-8966	GEAR HOLDER
104	601-6172	GEAR 48
105	601-6959	GEAR 64
106	601-9173	TIMING BELT
107	220-5373	VOL CONT B-5K
	220-5484	VOL CONT B-5K OHM
108	310-5029-F20	SUMITUBE F F 20MM
109	280-0419	HARNESS LUG
110	280-5009-01	CORD CLAMP 21
201	028-A00408-P	SET SCR HEX SKT CUP P M4 X 8
202	028-A00308-P	SET SCR HEX SKT CUP P M3 X 8
203	065-S012S0-Z	STP RING BLK OZ S12
204	065-S020S0-Z	STP RING BLK OZ S20
205	000-P00408-W	M SCR PH W/FS M4 X 8
206	000-P00412-W	M SCR PH W/FS M4 X 12
207	030-000612-S	HEX BLT W/S M6 X 12
208	060-F00600	FLT WSHR M6
209	030-000820-S	HEX BLT W/S M8 X 20
210	030-000840-S	HEX BLT W/S M8 X 40
211	068-852216	FLT WSHR 8.5-22 X 1.6
212	060-F00800	FLT WSHR M8
301	NCR-60055	WIRE HARN HANDLE VR

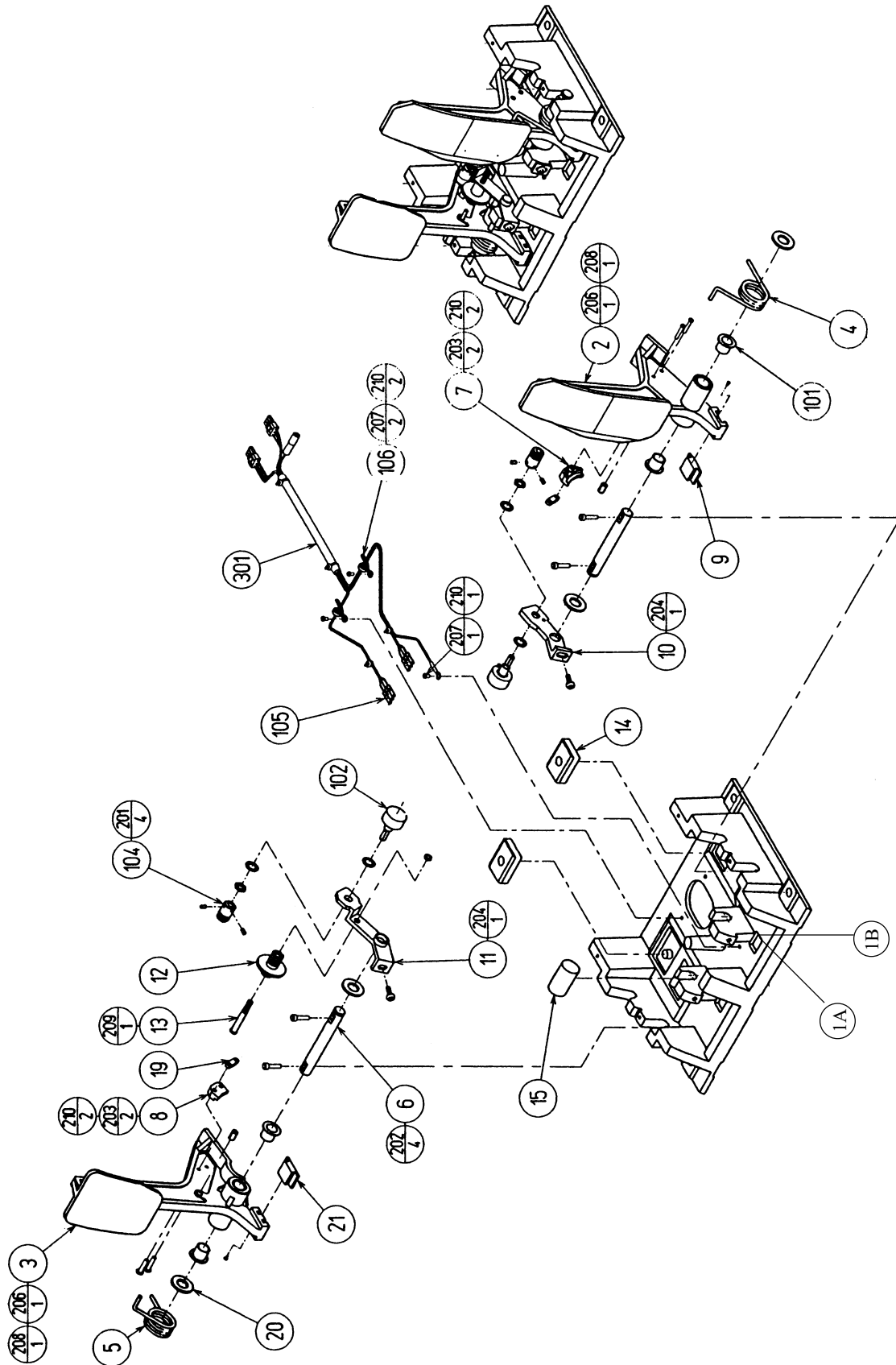

⑱ ASSY ACCEL&BRAKE (SPG-2200)

(D-2/2)

ITEM NO.	PART NO.	DESCRIPTION
1	SPG5-2201-A	BASE ACCELERATOR
	SPG5-2201-B	BASE BRAKE
2	SPG-2202	ACCEL PEDAL
3	SPG-2203	BRAKE PEDAL
4	SPG-2204	ACCEL SPRING
5	SPG-2205	BRAKE SPRING
6	SPG-2206	SHAFT
7	SPG-2207	ACCEL GEAR
8	SPG-2208	BRAKE GEAR
9	SPG-2209	NEUTRAL STOPPER
10	SPG-2210	VR PLATE ACCEL
11	SPG-2211	VR PLATE BRAKE
12	SPG-2212	AMPL GEAR
13	SPG-2213	GEAR SHAFT
14	SPG-2214	STOPPER
15	SPG-2215	RUBBER CUSHION
NOT SHOWN	999-1260	PEDAL PLATE LEFT
NOT SHOWN	999-1273	PEDAL PLATE RIGHT
NOT SHOWN	999-1274	PEDAL PLATE REAR (2)
19	SPG-2219	GEAR STAY
20	SPG-2220	WSHR
21	SPG-2221	NEUTRAL STOPPER D
101	100-5263	BEARING 12
102	220-5484	VOL CONT B-5K OHM
	220-5373	VOL CONT B-5K
104	601-7944	GEAR 15
105	310-5029-F15	SUMITUBE F F 15MM
106	280-0419	HARNESS LUG
201	028-A00304-P	SET SCR HEX SKT CUP P M3 X 4
202	020-000520-0Z	HEX SKT H CAP SCR BLK M5 X 20
203	000-P00420	M SCR PH M4 X 2
204	000-P00508-W	M SCR PH W/FS M5 X 8
205	000-T00408-0C	M SCR TH CRM M4 X 8
206	FAS-450005	SPR PIN BLK OZ 6 X 10
207	000-P00405	M SCR PH M4 X 5
208	FAS-000001	M SCR TH CRM M3 X 6
209	050-H00500	HEX NUT M5
210	060-F00400	FLT WSHR M4
301	600-6840	WIRE HARN ACCEL&BRAKE

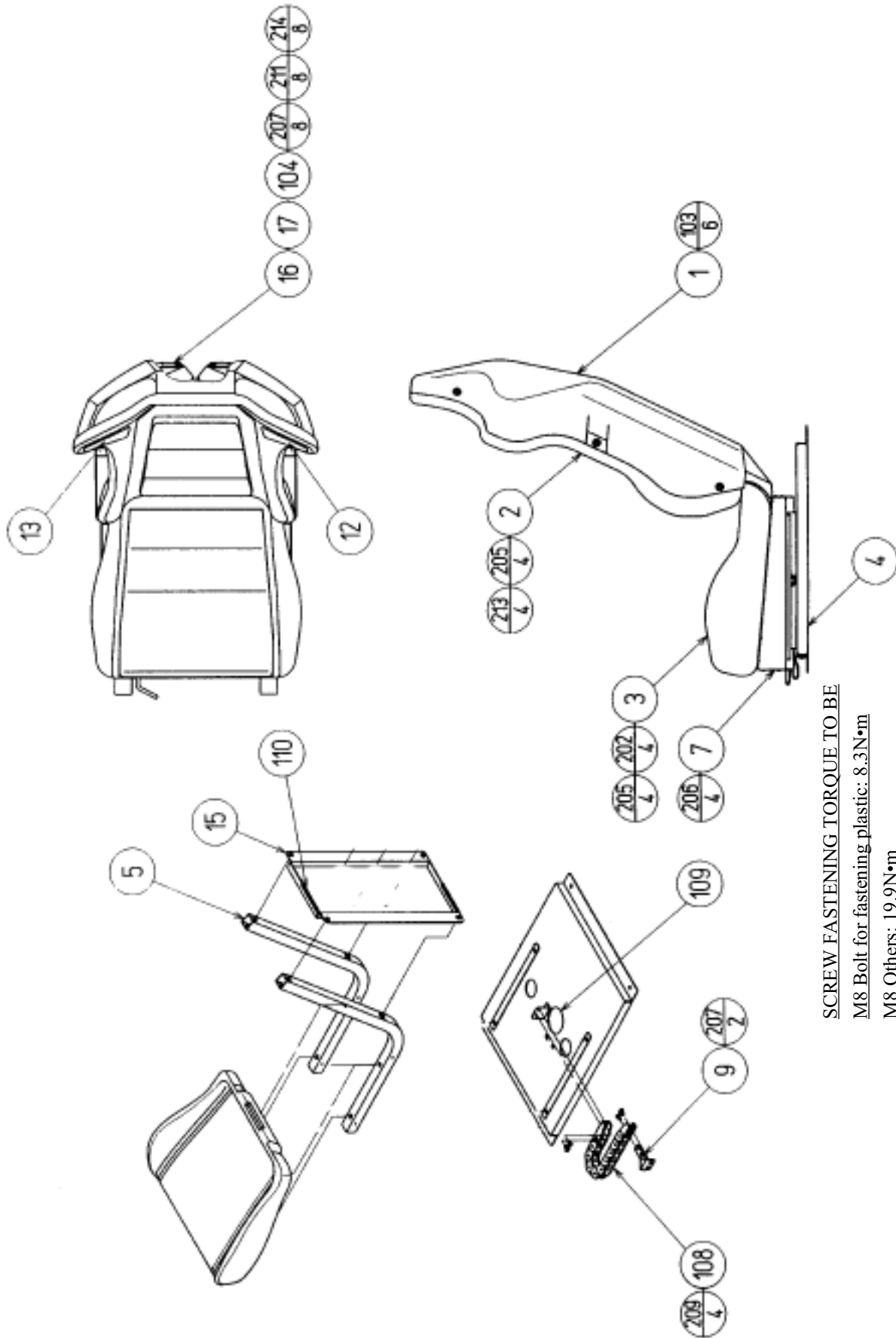

SCREW FASTENING TORQUE TO BE

M8 Bolt for fastening plastic: 8.3N•m

M8 Others: 19.9N•m

M4 Sonic Lock Portion: 0.9N•m

①9 ASSY SEAT (NCR-2400)

(D-2/2)

ITEM NO.	PART NO.	DESCRIPTION
1	999-1257	SEAT BACK COVER
2	NCR-2402	UPPER SEAT
3	NCR-2403	LOWER SEAT
4	NCR-2404	SEAT BASE
5	SRT-2402	SEAT FRAME
6	999-1048	TURTLE COVER
9	FRI-3309	CABLE BEAR BRKT
12	STC-1608	SPEAKER NET L
13	STC-1609	SPEAKER NET R
15	DUT-2205	SHAKER BASE REAR
16	STC-1607	SP MOUNT BRKT
17	INY-1302-B	MASK CUSHION SIDE
103	280-5297	SCRIVET 8 1K31
104	130-5162	GULL BOX SPEAKER 8OHM 8W
106	280-5009-01	CORD CLAMP 21
107	280-5275-SR10	CORD CLAMP SR10
108	601-6981-009	CABLE BEAR L=009
109	601-6563-225	BUSH 2.4T
201	030-000816-S	HEX BLT W/S M8 X 16
202	030-000850-S	HEX BLT W/S M8 X 50
203	050-H00800	HEX NUT M8
204	060-S00800	SPR WSHR M8
205	068-852216	FLT WSHR 8.5-22 X 1.6
206	000-T00408-0B	M SCR TH BLK M4 X 8
207	000-P00410-W	M SCR PH W/FS M4 X 10
208	000-T00516-0B	M SCR TH BLK M5 X 16
209	000-T00616-0B	M SCR TH BLK M6 X 16
210	000-P00408-S	M SCR PH W/S M4 X 8
211	060-F00400	FLT WSHR M4
212	050-U00400	U NUT M4
213	030-000855-S	HEX BLT W/S M8 X 55
214	012-P00412	TAP SCR #2 PH 4 X 12

②① CARD READER ASSY (999-1258)

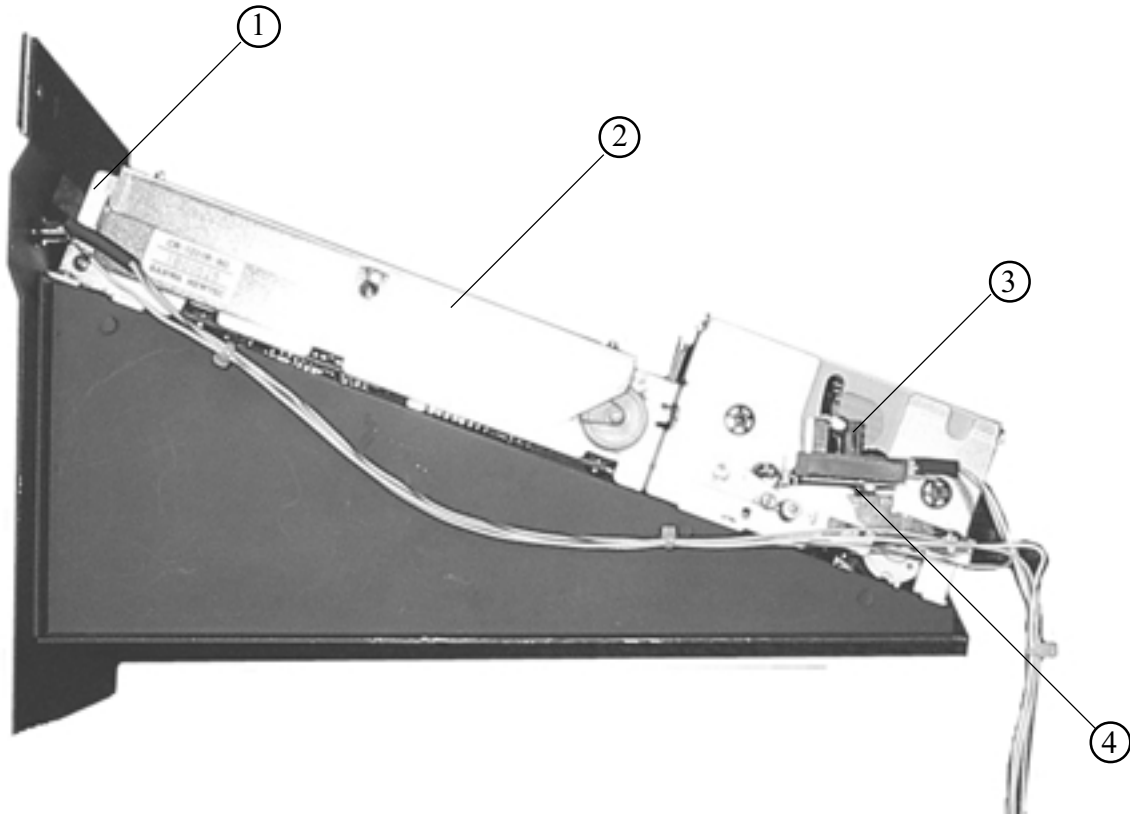

ITEM NO.	PART NO.	DESCRIPTION
1	253-5512	CARD GUIDE
2	601-11039	CARD R/W UNIT CR-1231R
3	999-1259	OPTIC UNIT
4	999-1272	OPTIC BRACKET
NOT SHOWN	601-11051-01	CARDS (200 PACK)
NOT SHOWN	6017-11050	CLEANING KIT

②① ASSY MAIN BD DX

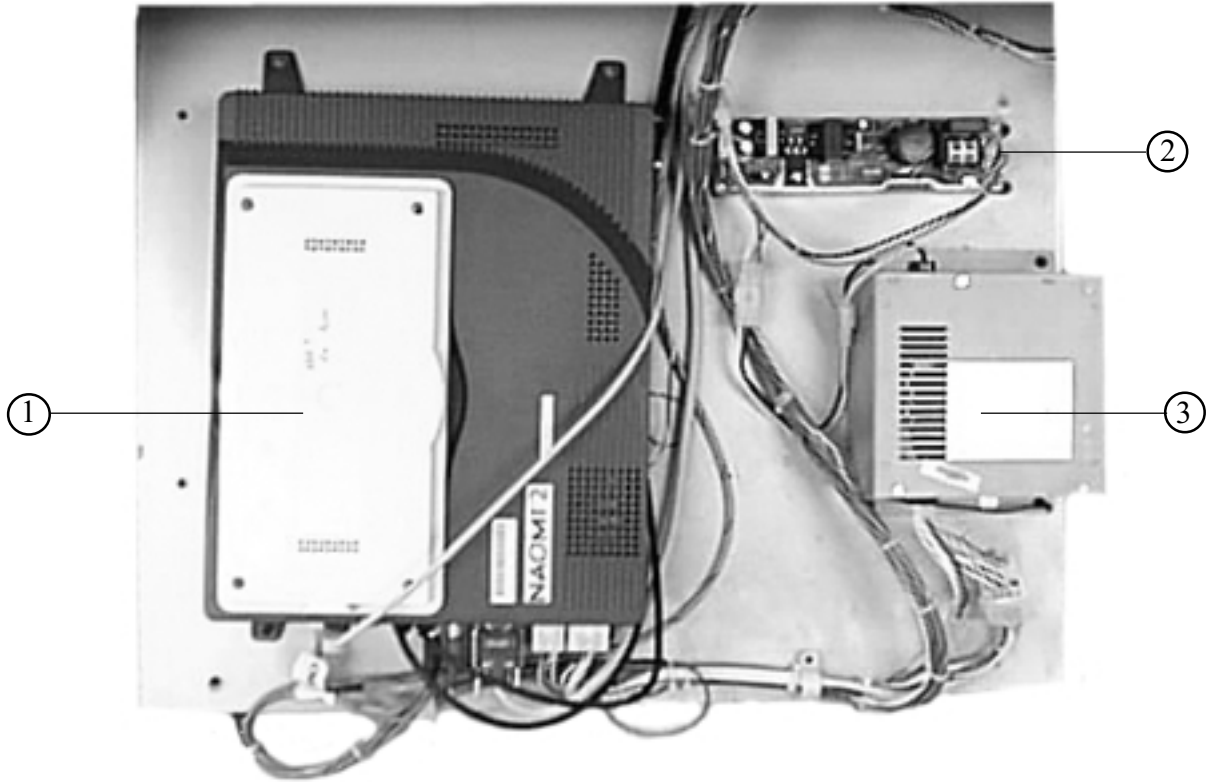

ITEM NO.	PART NO.	DESCRIPTION
1	840-0062D-01	ASSY CASE NAT CKT USA
2	400-5368-07512	SW REGU LCA75S-12 (Used for Card Reader)
3	400-5397-01	SW REGU DC 3.3V 12A 5V 10A 12V 2A

② ASSY AMP BD

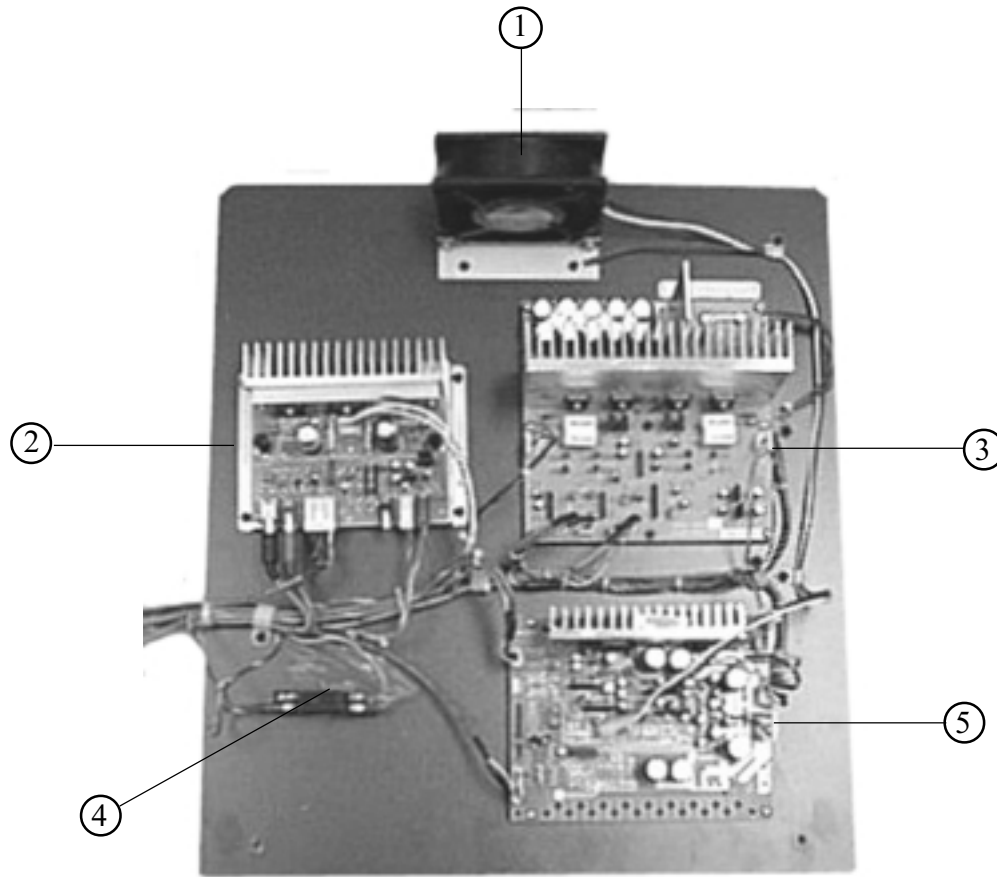

ITEM NO.	PART NO.	DESCRIPTION
1	LOC. PURCHASE	FAN AC120V
2	838-13616	AUDIO POWER AMP 2 CH
3	838-13844	PCB I/O CONTROL BD 2 FOR JVS
4	LOC. PURCHASE	FUSE BLOCK
5	838-13578	PWR AMP 2CH & MIXER

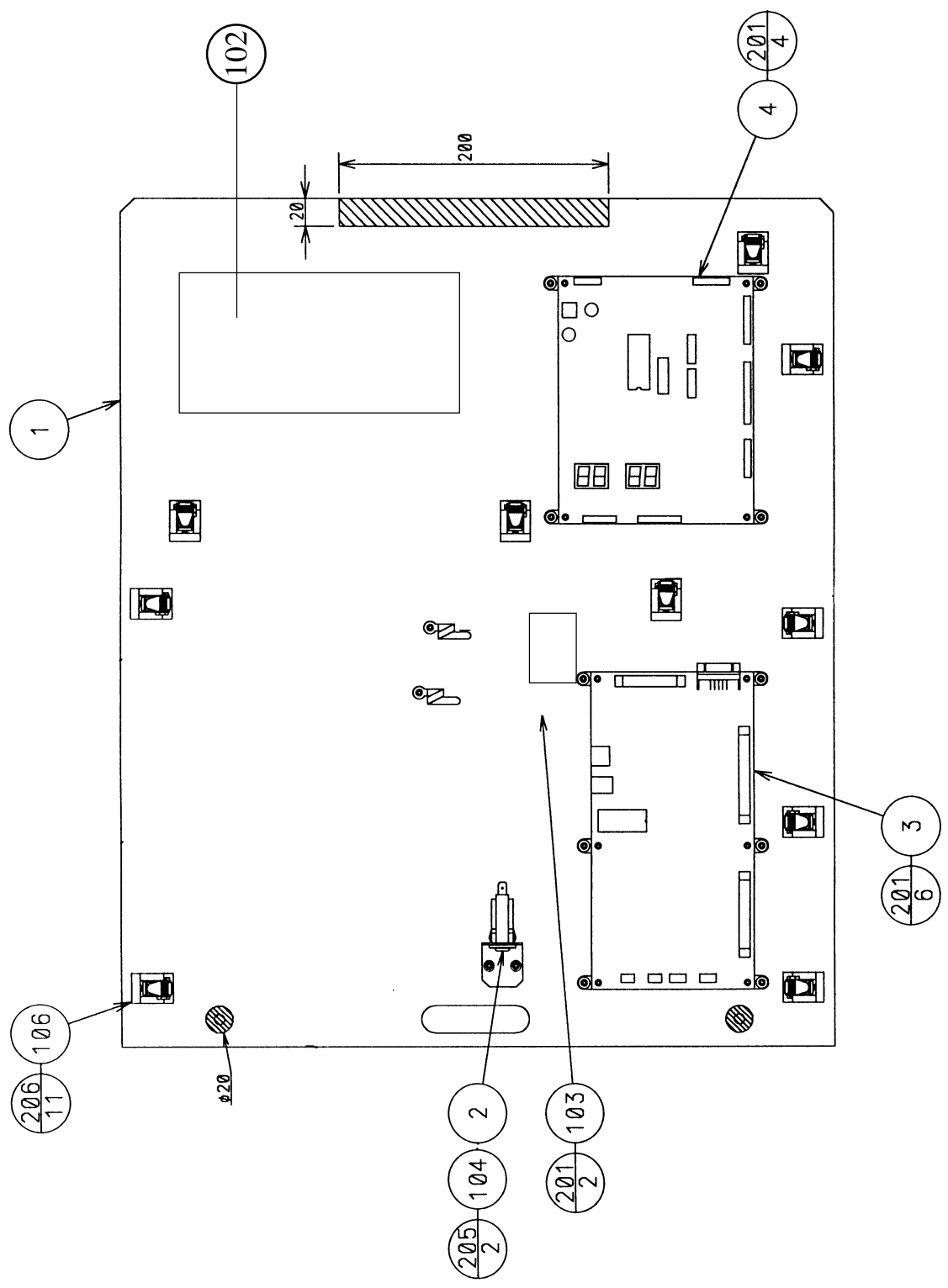

NOTE: 1. MAKE SURE THAT THERE IS NO WIRING, ETC. IN THE SLASH MARK PORTIONS.

2. Set all the DIP switches (837-13844 (4B) and 838-13366 (4C)) to OFF.

ITEM NO.	PART NO.	DESCRIPTION
1	NCR-4201	WOODEN ELEC BASE
2	NCR-4202	C.P.BRKT
3	837-13844	I/O CONTROL BD 2 FOR JVS FRI
4	838-13366	DRIVE BD SRT
5	838-12912-01	SERVO MOTOR DRIVE BD NEW
7	421-7468-01	STICKER C.P W/PIC
102	998-0135	POWER TRANSFORMER ER-501
103	117-5225	FUSES 1-6.25 A SLOW BLOW 2-3A SLOW BLOW 1-15A SLOW BLOW
104	512-5046-15000	C.P 15000MA CE UL
105	310-5029-K20	SUMITUBE F K 20MM
106	280-5009-01	CORD CLAMP 21
108	601-0460	PLASTIC TIE BELT 100 MM
201	011-T00316	TAP SCR TH 3 X 16
202	011-T00325	TAP SCR TH 3 X 25
203	000-P00516-W	M SCR PH W/FS M5 X 16
204	000-P00416-W	M SCR PH W/FS M4 X 16
205	011-T03512	TAP SCR TH 3.5 X 12
206	011-F00312	TAP SCR #1 FH 3 X 12

21. WIRE COLOR CODE TABLE

THE WIRE COLOR CODE is as follow:

- A PINK
- B SKY BLUE
- C BROWN
- D PURPLE
- E LIGHT GREEN

Wires other than those of any of the above 5 single colors will be displayed by 2 alphanumeric characters.

- 1 RED
- 2 BLUE
- 3 YELLOW
- 4 GREEN
- 5 WHITE
- 7 ORANGE
- 8 BLACK
- 9 GRAY

If the right-hand side numeral of the code is 0, then the wire will be of a single color shown by the left-hand side numeral (see the above).

Note 1: If the right-hand side alphanumeric is not 0, that particular wire has a spiral color code. The left-hand side character shows the base color and the right-hand side one, the spiral color.

<Example> 51 WHITE / RED

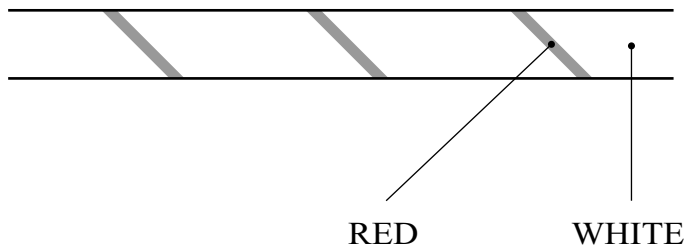

Note 2: The character following the wire color code indicates the size of the wire.

- U: AWG16
- K: AWG18
- L: AWG20
- None: AWG22

Warranty

Your new Sega Product is covered for a period of 90 days from the date of shipment. This certifies that the Printed Circuit Boards, Power Supplies and Monitor are to be free of defects in workmanship or materials under normal operating conditions. This also certifies that all Interactive Control Assemblies are to be free from defects in workmanship and materials under normal operating conditions. No other product in this machine is hereby covered.

Sellers sole liability in the event a warranted part described above fails shall be, at its option, to replace or repair the defective part during the warranty period. For Warranty claims, contact your Sega Distributor.

Should the Seller determine, by inspection that the product was caused by Accident, Misuse, Neglect, Alteration, Improper Repair, Installation or Testing, the warranty offered will be null and void.

Under no circumstances is the Seller responsible for any loss of profits, loss of use, or other damages.

This shall be the exclusive written Warranty of the original purchaser expressed in lieu of all other warranties expressed or implied. Under no circumstance shall it extend beyond the period of time listed above.



SEGA ENTERPRISES, INC. (USA)

45133 Industrial Drive
Fremont, CA 94538
(415) 701-6580 phone
(415) 701-6594 fax