

SEGA™

GENESIS™

INSTRUCTION MANUAL

EPILEPSY WARNING

WARNING: READ BEFORE USING YOUR SEGA VIDEO GAME SYSTEM

A very small percentage of individuals may experience epileptic seizures when exposed to certain light patterns or flashing lights. Exposure to certain light patterns or backgrounds on a television screen or while playing video games may induce an epileptic seizure in these individuals. Certain conditions may induce undetected epileptic symptoms even in persons who have no history of prior seizures or epilepsy. If you, or anyone in your family, has an epileptic condition, consult your physician prior to playing. If you experience any of the following symptoms while playing a video game: dizziness, altered vision, eye or muscle twitches, loss of awareness, disorientation, any involuntary movement, or convulsions, IMMEDIATELY discontinue use and consult your physician before resuming play.

WARNING

Operates only with NTSC televisions, Genesis, and Sega CD systems purchased in North and South America (except Argentina, Paraguay and Uruguay). Will not operate with any other televisions, Genesis or Sega CD system.

GAME PLAY ASSISTANCE AND INFORMATION

For expert game play assistance or information on other great Sega products, call the Sega experts at:

1-415-591-PLAY

IF YOU NEED HELP

Read this manual thoroughly before connecting your Genesis system. If you have difficulties, first consult the troubleshooting section. For service, call the Sega Consumer Service Department at:

1-800-USA-SEGA

IDENTIFYING PARTS

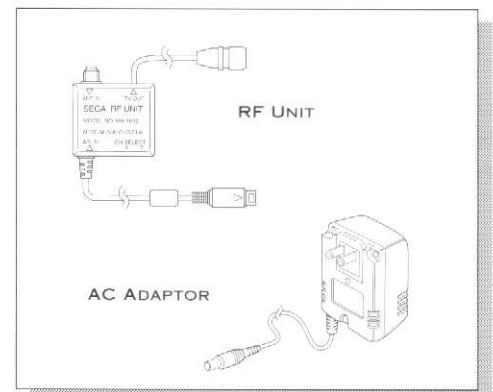
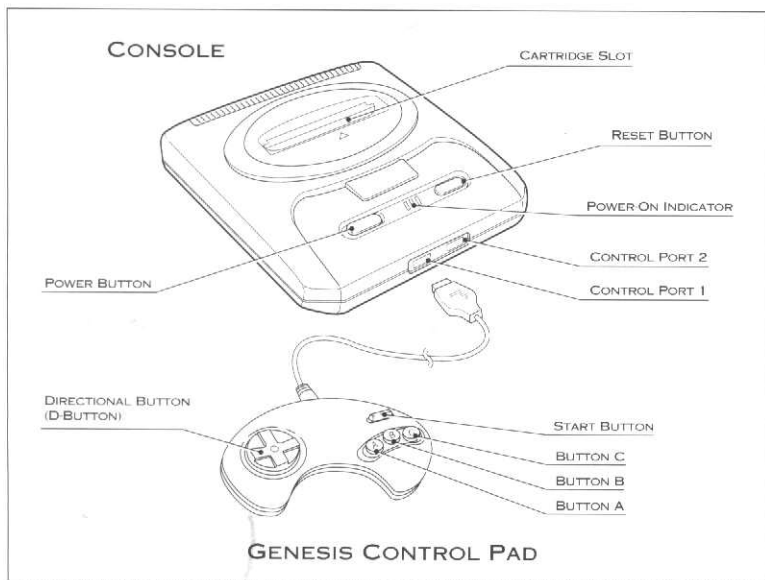

PRECAUTIONS

- When the AC adaptor is not in use, unplug it from the electrical outlet.
- Do not leave the system or any of its parts in direct sunlight, in damp areas or near a heater.
- Use only the Genesis AC adaptor *supplied with this system*. Using a different AC adaptor will damage your system and void the warranty.
- Do not disassemble the console or any of its parts.

CONNECTING THE SEGA GENESIS

HOOKING UP THE SEGA GENESIS SYSTEM IS SIMPLE!

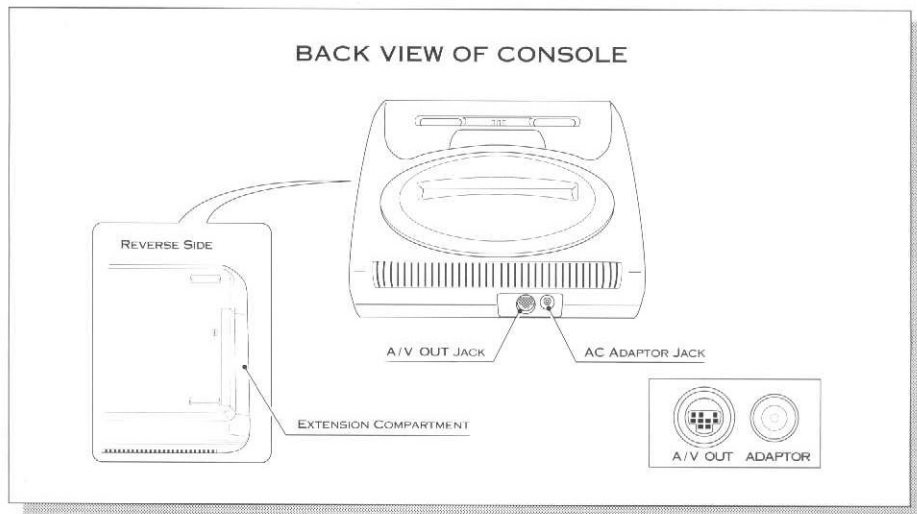

CONNECTIONS TO TV/MONITOR AND ANTENNA

There are various types of TV sets and antenna terminals. You may need to use all or some of the three following types of connectors:

- RF Unit (model no. 1632) (included)
- F-type converter (300/75 ohm) (not included)
- Matching transformer (75/300 ohm) (not included)

Compare your TV to the illustrations to decide which procedure is necessary.

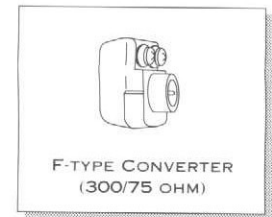
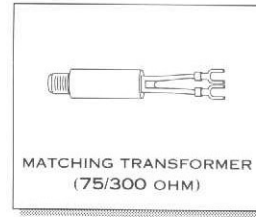

IF YOUR TV DOES NOT HAVE VIDEO AND AUDIO INPUTS, USE ONE OF THE FOLLOWING PROCEDURES:

TV WITH SINGLE-PLUG ANTENNA CABLE (FOR EITHER CABLE TV OR VHF ANTENNA CABLE)

If a single-plug antenna cable is plugged into your TV (or if you have cable TV), use the RF Unit. No other connectors are necessary.

1. Unplug the antenna cable from the TV, and plug it into the RF Unit.
2. Now, plug the RF Unit antenna cable into the TV.
3. Finally, plug the RF cable into the A/V OUT jack on the back of the Genesis console.
4. To continue, see "POWERING UP THE SYSTEM".

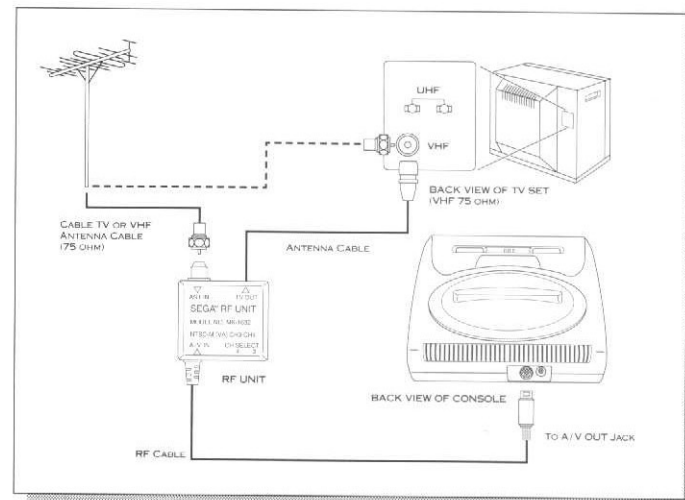
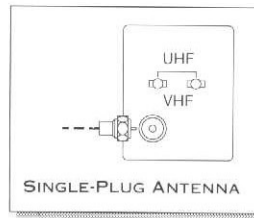

TV WITH F-TYPE CONVERTER

If an F-type converter is plugged into your TV, use the RF Unit. No other connectors are necessary.

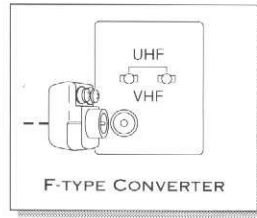

1. Find the F-type converter that's connected to the antenna and plugged into the TV. Unplug it from the TV, and plug it into the RF Unit.
2. Now, plug the RF Unit antenna cable into the TV.
3. Finally, plug the RF cable into the A/V OUT jack on the back of the Genesis console.
4. To continue, see "POWERING UP THE SYSTEM".

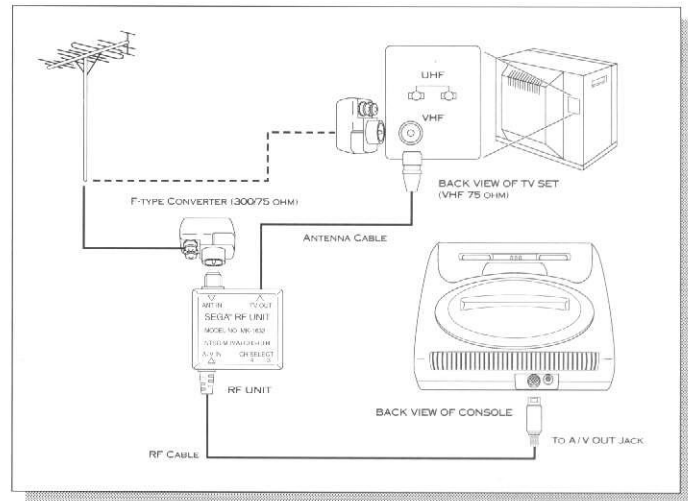

TV WITH AN ANTENNA CABLE CONSISTING OF A TWIN-LEAD ANTENNA WIRE

If the antenna cable consists of a twin-lead antenna wire connected to your TV, you'll need a matching transformer and an F-type converter (both available from electronics stores) and the RF Unit (included).

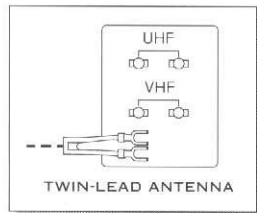

1. Disconnect the twin-lead antenna wire from the TV, and connect it to the F-type converter.
2. Plug the F-type converter into the RF Unit.
3. Plug the RF Unit Antenna Cable into the matching transformer. Connect the transformer's twin-lead antenna wire to the back of the TV.
4. Finally, plug the RF cable into the A/V OUT jack on the back of the Genesis console.
5. To continue, see "POWERING UP THE SYSTEM".

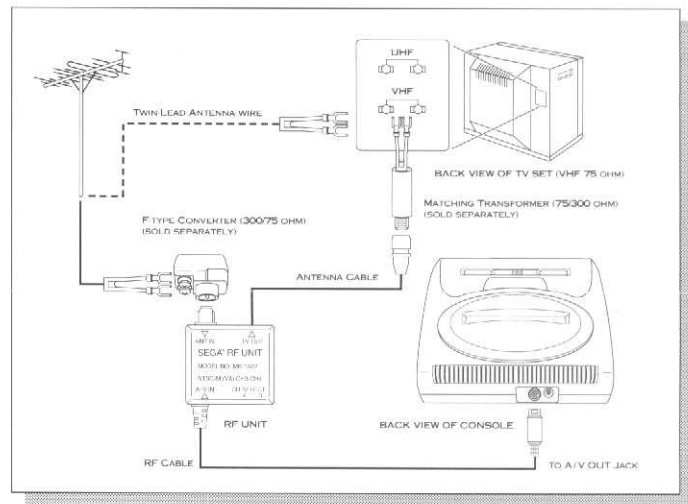

TV WITH CABLE TV OR VHF ANTENNA CABLE PLUGGED INTO MATCHING TRANSFORMER

If cable TV or a VHF antenna cable is already plugged into a matching transformer on the back of your TV, use the RF Unit with your matching transformer.

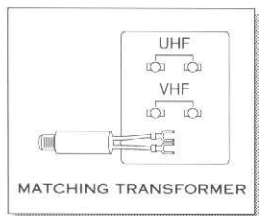

1. Leave the twin-lead antenna wire of the matching transformer connected to the TV. Unplug the VHF antenna cable from the other end of the transformer.
2. Plug the VHF antenna cable into the RF Unit.
3. Plug the RF Unit antenna cable into the matching transformer.
4. Finally, plug the RF cable into the A/V OUT jack on the back of the Genesis console.
5. To continue, see "POWERING UP THE SYSTEM".

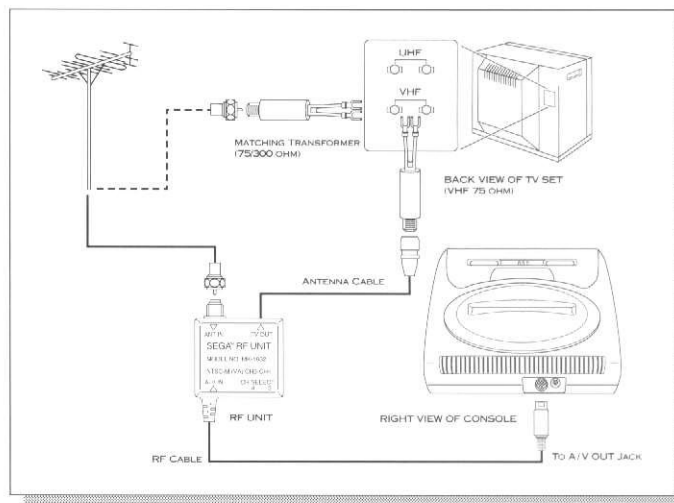

TV WITH CONNECTED VIDEO CASSETTE RECORDER (VCR)

If a video cassette recorder (VCR) is already connected between the antenna and the television's VHF terminals, use the RF Unit (and, if necessary, an F-type converter and/or a matching transformer — both available from electronics stores).

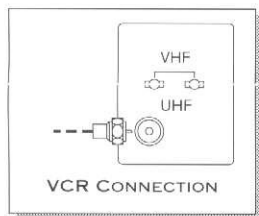

1. Disconnect the VCR cable from the television's VHF terminal (or from its matching transformer). Then, plug this cable into the RF Unit. (If this cable has a twin-lead antenna wire, use an F-type converter to make this connection.)
2. Plug the RF Unit antenna cable into the television's VHF terminal. (If a twin-lead antenna wire is required, use a matching transformer to make this connection.)
3. Finally, plug the RF cable into the A/V OUT jack on the back of the Genesis console.
4. To continue, see "POWERING UP THE SYSTEM".

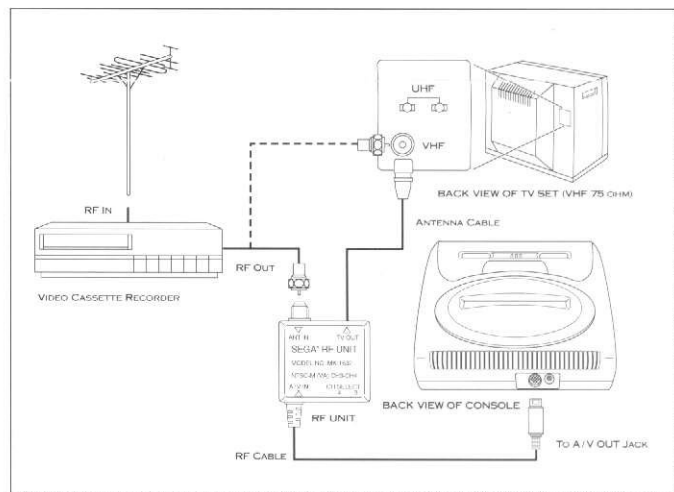

OPTIONAL HOOKUPS

IF YOUR TV HAS VIDEO AND AUDIO INPUTS, USE ONE OF THE FOLLOWING PROCEDURES:

TV WITH VIDEO AND MONO AUDIO INPUT JACKS, (OR VCR, IF TV IS CONNECTED TO VCR)

If your TV has video and mono audio input jacks (usually on the back of recent models), you can use the *optional Sega Audio/Video Cable* (model no. 1634) for improved graphics and sound. No other connectors are necessary.

If your TV is connected to your VCR, it is also possible to achieve improved graphics and sound by using the *optional Sega Audio/Video Cable* (model no. 1634) with your VCR.

To order the **Sega Audio/Video Cable**, see the Parts Order Form enclosed with this manual and call 1-800-USA-SEGA, or contact your local retailer.

1. Insert the single-plug end of the **Audio/Video Cable** into the A/V OUT jack on the Genesis console.
2. Insert the yellow plug on the **Audio/Video Cable** into the composite TV or monitor's video input jack (or into the VCR video input jack). Insert the white plug into the TV or monitor's audio input jack (or into the VCR audio input jack).

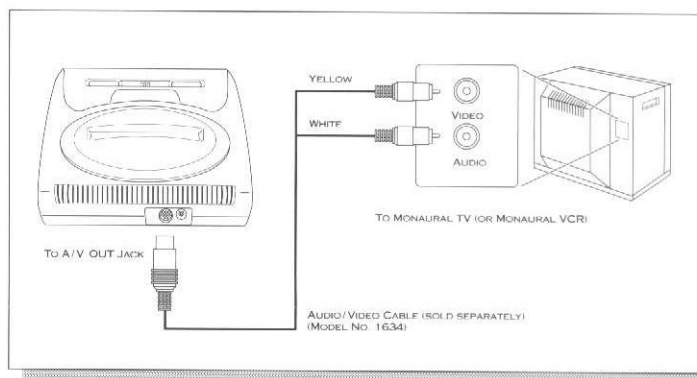

3. Lastly, select the audio/video input setting on your TV (or VCR), when playing the Genesis.
4. To continue, see "POWERING UP THE SYSTEM".

TV WITH VIDEO AND STEREO AUDIO INPUT JACKS (STEREO TV), OR TV CONNECTED TO STEREO VCR

If your TV has video and stereo audio input jacks (stereo TV) or is connected to a stereo VCR, you can use the *optional Sega Stereo Audio/Video Cable* (model no. 1635) for improved graphics and stereo sound. No other connectors are necessary.

To order the **Sega Stereo Audio/Video Cable** (model no. 1635), see the Parts Order Form enclosed with this manual and call 1-800-USA-SEGA, or contact your local retailer.

1. Insert the single-plug end of the **Stereo Audio/Video Cable** into the A/V OUT jack on the Genesis console.
2. Insert the yellow plug on the **Stereo Audio/Video Cable** into the composite TV or monitor's video input jack (or into the VCR video input jack). Insert the white plug into the left audio input jack, and the red plug into the right audio input jack of the TV or monitor (or VCR).
3. Lastly, select the audio/video input setting on your TV (or VCR) when playing the Genesis.
4. To continue, see "POWERING UP THE SYSTEM".

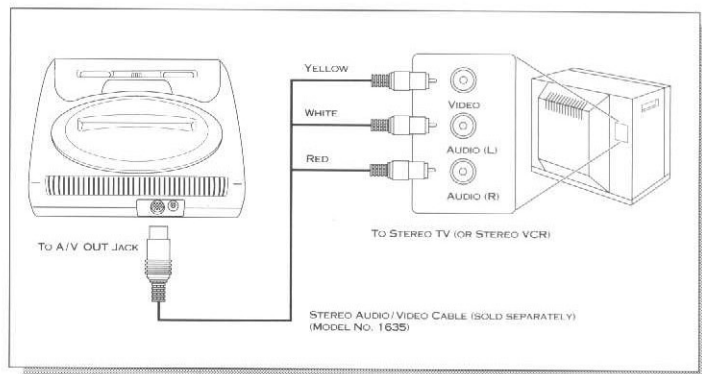

STEREO SOUND FOR TV WITHOUT STEREO AUDIO INPUT JACKS THROUGH A HOME STEREO OR STEREO VCR

If you have a mono audio TV, you can still enjoy stereo sound from your Genesis through your home stereo system or stereo VCR. Use the *optional Sega Stereo Audio/Video Cable* (model no. 1635) for improved graphics and stereo sound. No other connectors are necessary.

To order the **Sega Stereo Audio/Video Cable** (model no. 1635), see the Parts Order Form enclosed with this manual and call 1-800-USA-SEGA, or contact your local retailer.

1. Insert the single-plug end of the **Stereo Audio/Video Cable** into the A/V OUT jack on the Genesis Console.
2. Insert the yellow plug on the **Stereo Audio/Video Cable** into the composite TV or monitor's video input jack (or into the VCR video input jack if the VCR is connected to the stereo, and the TV is connected to the VCR).
3. Insert the red cable plug into the right audio input jack, and the white plug into the left audio input jack of your stereo (or VCR). If your stereo is not located very close to your TV, you may need an *optional* female to male RCA extension cable.

Note: *Always* have the volume control turned all the way down when you first turn on the Genesis System.

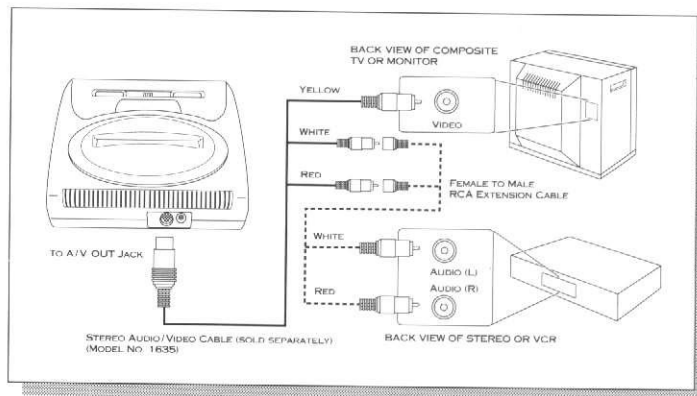

POWERING UP THE SYSTEM

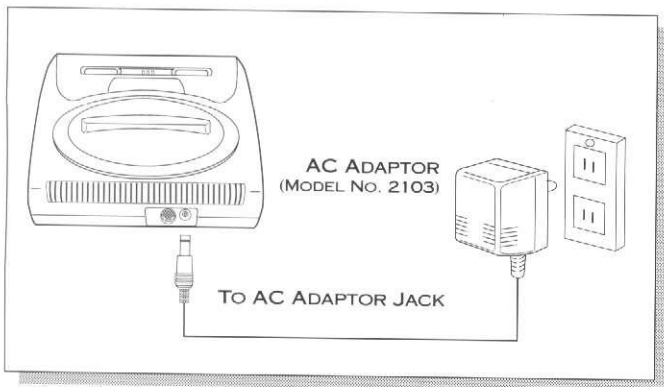

- Connect the AC adaptor plug to the ADAPTOR jack on the back of the Genesis console.
- Plug the AC adaptor into an electrical outlet.

TV CHANNEL SETTING

1. If you are using the RF Unit, set the channel switch on the RF Unit to CH 3. If you are not using the RF Unit, go to page 15.
2. Set your TV to channel 3.
3. If channel 3 is used for TV viewing, set your TV to channel 4. Then, switch the channel switch on the RF Unit to CH 4.
4. If your TV has an automatic fine-tuning control (AFC), turn it off and manually adjust the picture. However, if you have a color TV that turns black and white when the AFC is turned off, leave the AFC on.

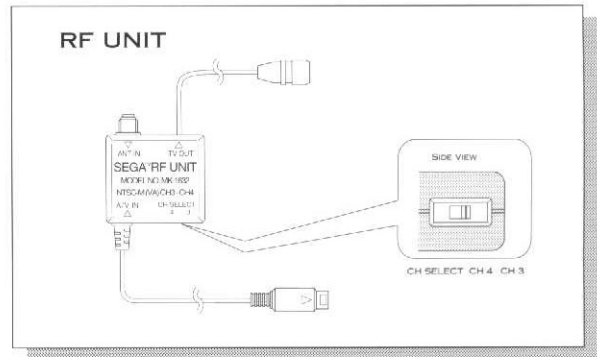

OPERATING THE SYSTEM

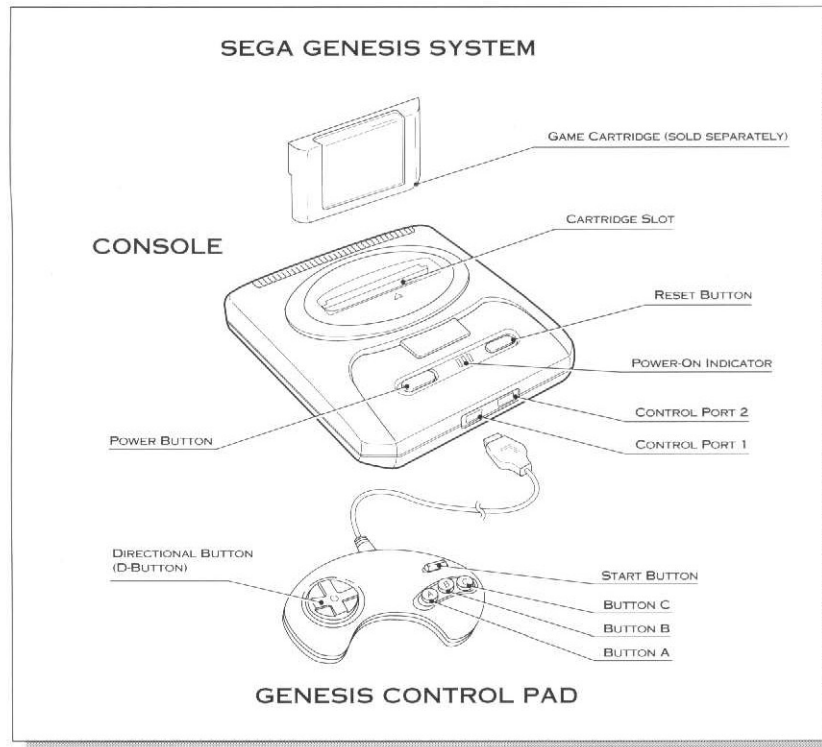

1. Plug a Genesis Control Pad into control port 1 on the console. For two players, plug a second Genesis Control Pad (optional) into control port 2.
2. Turn the power button off. Check it by making sure the power-on indicator light is not on.
3. Insert a cartridge, with the label facing forward, into the cartridge slot. Press it *firmly* into the slot until the cartridge "locks" into place. (If you turn the console over, the cartridge should remain in place.)
4. Turn the power on. The power-on indicator light should come on.
5. If all connections have been made properly, the Sega logo will appear, followed by the game's title screen. In some cases, a demonstration game will then begin (see the game's instruction manual). Always turn the Sega Genesis system power button off before removing a game cartridge.

CONNECTING THIS GENESIS TO A SEGA CD

If your Sega CD looks like this, use these instructions to connect your Genesis and Sega CD.

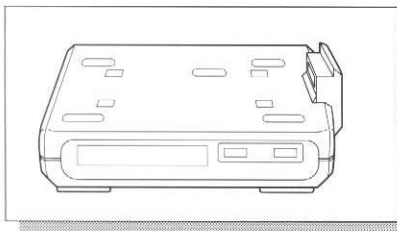

If your Sega CD looks like this, refer to your Sega CD User's Guide for details on how to connect it to your Genesis.

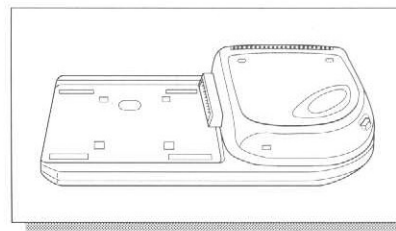

Use the steel joining plate supplied with the original Sega CD to connect the Genesis to the Sega CD. Follow the procedure below to attach the steel joining plate to the Genesis. You'll need to use a standard screwdriver and a Phillips-head screwdriver when attaching the steel joining plate.

• *For details on the functions and operation of the Sega CD, please refer to the Sega CD Owner's Manual.*

1. Make sure your Genesis system is set up and operating properly.
2. Turn off the power button of the Genesis, and remove its AC adaptor from the power outlet. (If the Sega CD AC Adaptor is also plugged in, remove it from the power outlet.)
3. Remove the five rubber pads on the bottom of the Genesis with a screwdriver or a similar tool. (See illustration 1.)
4. Attach the small connector plate to the bottom of the Genesis. The plate hooks into position over the vents. (See illustration 2.)

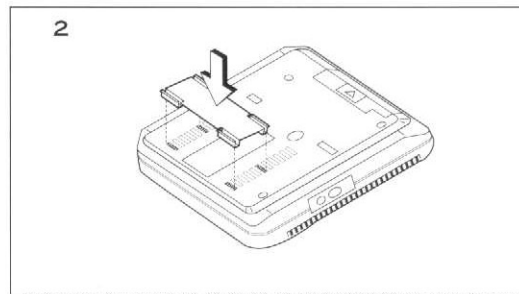
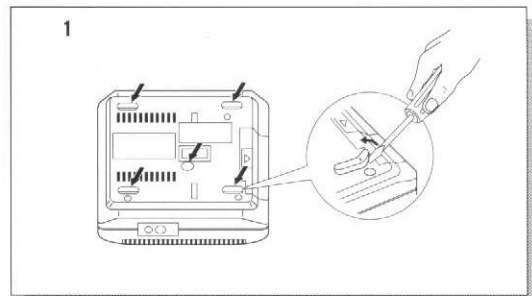

- Remove the cover of the expansion slot panel, located on the bottom of the Genesis. Remove the red plastic cover from the expansion slot connector (ignore the labelled message "DO NOT REMOVE"). Store both covers in a safe place. (See illustration 3.)

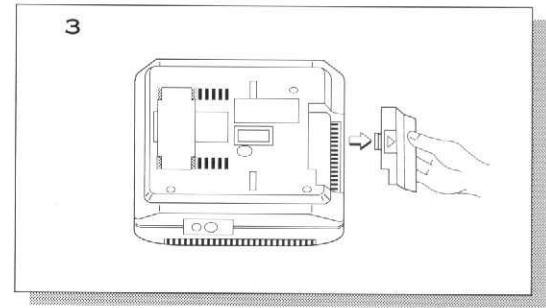

- Position the steel joining plate on the bottom of the Genesis, over the small connector plate. Secure the steel joining plate with the supplied screw. (See illustration 4.)

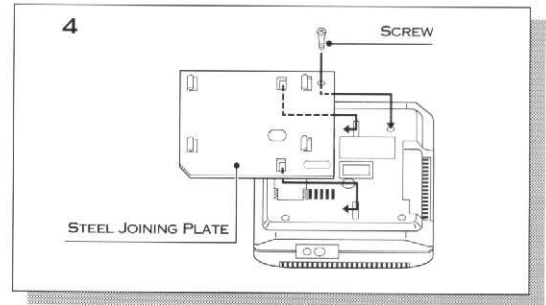

- Slide the Genesis onto the Sega CD. Make sure the connector in the Genesis expansion slot fits snugly into the connector terminal on the Sega CD. (See illustration 5.)

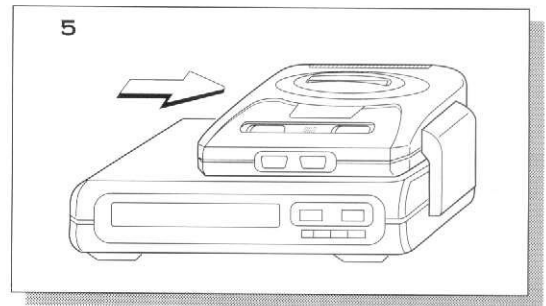

- Make sure the Genesis power button is turned off. Then plug in its AC adaptor. (See illustration 6.)

Note: Always lift the Genesis and the Sega CD together by holding onto the sides of the Sega CD.

- Plug the Sega CD's AC adaptor cable into its jack on the back of the Sega CD console. Then plug the adaptor directly into an electrical outlet. **Do not use an extension cord.** (See illustration 6.)

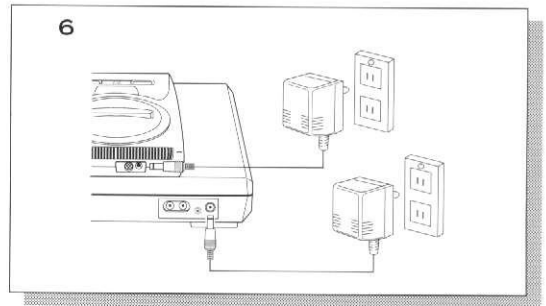

Note: Do not switch the AC adaptors. Use the Genesis AC Adaptor **only** with the Genesis, and the Sega CD AC Adaptor **only** with the Sega CD.

STEREO SOUND

- For stereo TV/stereo VCR — use the **Sega Stereo Audio Video Cable**. See “TV WITH VIDEO AND STEREO AUDIO INPUT JACKS (STEREO TV), OR TV CONNECTED TO STEREO VCR”.
- For non-stereo TV — use the **Sega Stereo Audio/Video Cable** and a female-to-male RCA extension cable (see “STEREO SOUND FOR TV WITHOUT STEREO AUDIO INPUT JACKS THROUGH A HOME STEREO OR STEREO VCR”) *or* the **Sega Audio/Video Cable** and standard 2-pin RCA cable (see the *Sega CD Owner’s Manual*, “CONNECTING A STEREO TV”).

TROUBLESHOOTING THE GENESIS SYSTEM

NO PICTURE ON SCREEN.

- Is the cartridge pushed *firmly* into the game slot?
- Is the Genesis console turned on?
- Is the AC adaptor plugged in properly?
- Is the TV turned on?
- Is there power to the wall socket?
- Is the channel switch setting on the RF Unit the same as the TV channel being used?
- Review the connections between the antenna cable, Genesis console, and TV terminals.
- If connecting through the VCR — is the VCR turned on?
- If connecting through the VCR — is the VCR set to receive line input?

SCREEN FLICKERS OR NO COLOR.

- Are the antenna cables connected properly?
- Are the TV channel fine adjustments set properly?
- Are the TV color controls set properly?
- Is the Genesis cartridge inserted properly?

NO GAME SOUND.

- Is the TV volume too low, or off?
- Have the connection cables come loose, or gotten disconnected?

PICTURE ON TV SCREEN IS UNSTEADY.

- Adjust the vertical and horizontal hold controls on the TV.

FRINGES APPEAR ON TV DURING A GAME.

- Adjust the manual fine-tuning adjustment controls on the TV.

FRINGES APPEAR ON TV DURING A BROADCAST.

- Is the antenna cable connected properly?
- Make sure that you have turned off the power switch on the Genesis console.

NO POWER LIGHT.

- Is there power to the wall socket?

If you continue to have a problem, use this manual to carefully re-connect the system, step by step. If the problem still exists, please call the Sega Consumer Service Department, toll free, at 1-800-USA-SEGA.

LIMITED WARRANTY

Sega of America, Inc. warrants to the original consumer purchaser that the Sega Genesis System and all component parts shall be free from defects in material and workmanship for a period of 90 days from the date of purchase. If a defect covered by this limited warranty occurs during the 90-day limited warranty period, Sega will repair or replace the defective system or component part, at its option, free of charge.

This limited warranty does not apply if the defects have been caused by negligence, accident, unreasonable use, modifications, tampering, or any other causes not related to defective materials or workmanship. Additionally, this warranty shall not be valid if the serial number of the Genesis unit has been altered, defaced or removed in any way.

Please retain your dated sales receipt to easily establish the date of purchase for in-warranty repairs.

To receive warranty service, call the Sega Consumer Service Department at:

1-800-USA-SEGA

To receive Canadian warranty service, call the Sega of Canada Consumer Service Department at:

1-800-872-7342

PLEASE CALL FIRST FOR REPAIR INFORMATION. The cost of returning the system to Sega's Service Center shall be paid by the purchaser.

DO NOT RETURN YOUR SEGA GENESIS SYSTEM TO THE RETAIL SELLER.

REPAIRS AFTER EXPIRATION OF LIMITED WARRANTY

If your Sega Genesis System requires repairs after termination of the 90-day limited warranty period, you may contact the Sega Consumer Service Department at the number listed above. If the technician is unable to solve the problem by phone, he or she will advise you of the estimated cost of repair. If you elect to have the repair done, you will need to return the defective merchandise, freight prepaid and insured against loss or damage, to Sega's Service Center with an enclosed check or money order payable to Sega of America, Inc. for the amount of the cost estimate provided to you by the technician. If, after inspection, it is determined that your system cannot be repaired, it will be returned to you and your payment will be refunded.

Patents:

U.S. Nos. 4,442,486/4,454,594/4,462,076/4,026,555; Europe No. 80244;
Canada Nos. 1,183,276/1,082,351; Hong Kong No. 88-4302;
Germany No. 2,609,826; Singapore No. 88-155; U.K. No. 1,535,999;
France No. 1,607,029; Japan Nos. 1,632,396/82-205605 (Pending)

LIMITATIONS ON WARRANTY

Any applicable implied warranties, including warranties of merchantability and fitness for a particular purpose, are hereby limited to 90 days from the date of purchase and are subject to the conditions set forth herein. In no event shall Sega of America, Inc. be liable for consequential or incidental damages resulting from the breach of any express or implied warranties.

The provisions of this limited warranty are valid in the United States only. Some states do not allow limitations on how long an implied warranty lasts or exclusion of consequential or incidental damages, so the above limitation or exclusion may not apply to you. This limited warranty provides you with specific legal rights. You may have other rights which vary from state to state.

WARNING STATEMENT

This equipment has been tested and found to comply with the limits for a Class B digital device, pursuant to Part 15 of the FCC Rules. These limits are designed to provide reasonable protection against harmful interference in a residential installation. This equipment generates, uses and can radiate radio frequency energy and, if not installed and used in accordance with the instructions, may cause harmful interference to radio communications. However, there is no guarantee that interference will not occur in a particular installation. If this equipment does cause harmful interference to radio or television reception, which can be determined by turning the equipment off and on, the user is encouraged to try to correct the interference by one or more of the following measures:

- Reorient or relocate the receiving antenna.
- Increase the separation between the equipment and the receiver.
- Connect the equipment into an outlet on a circuit different from that to which the receiver is connected.
- Consult the dealer or an experienced radio/TV technician for help.

Changes or modification not expressly approved by Sega Enterprises Ltd., could void the user's authority to operate the equipment.

Warning to owners of projection televisions: Still pictures or images may cause permanent picture-tube damage or mark the phosphor of the CRT. Avoid repeated or extended use of video games on large-screen projection televisions.