

TEE OFF™

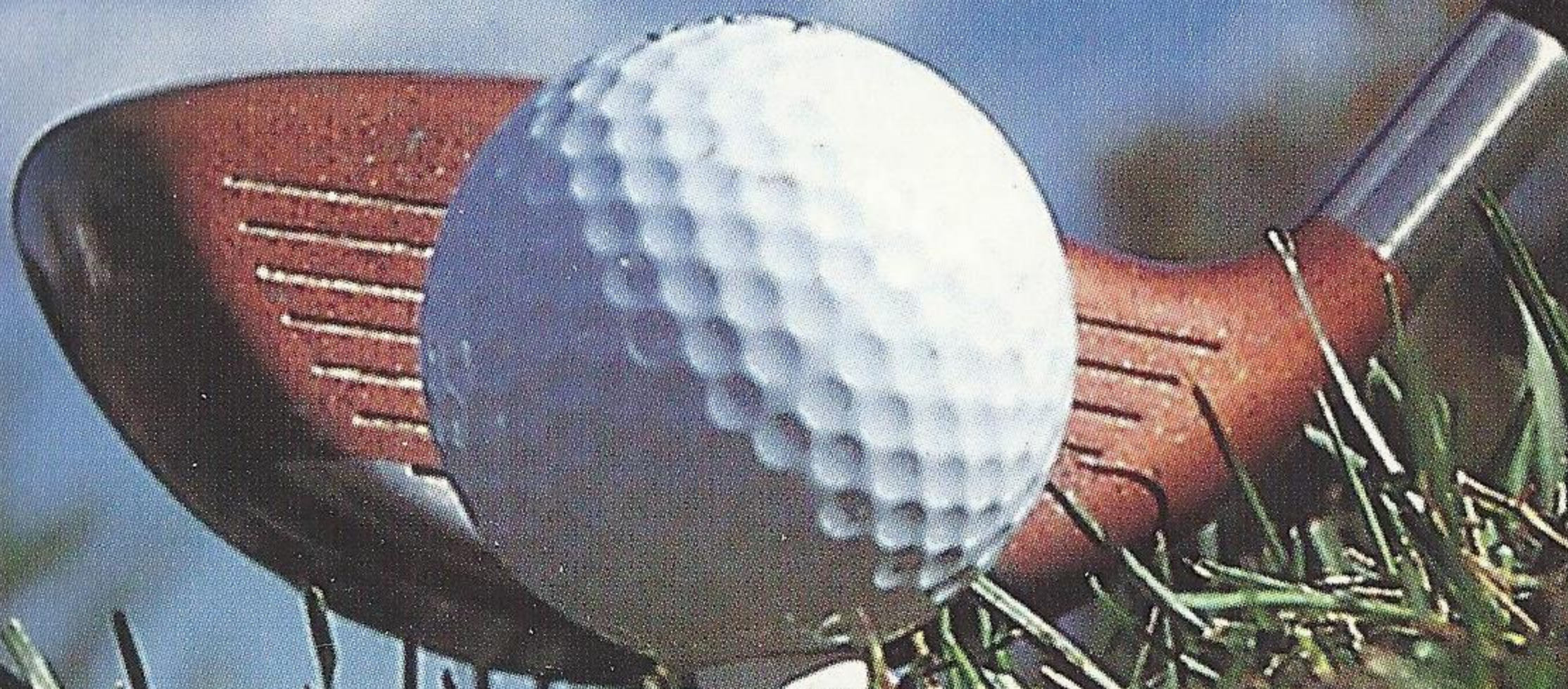

AKKlaim®



T-8108N

SEGA®

WARNINGS Read Before Using Your Sega Dreamcast Video Game System

CAUTION

Anyone who uses the Sega Dreamcast should read the operating manual for the software and console before operating them. A responsible adult should read these manuals together with any minors who will use the Sega Dreamcast before the minor uses it.

HEALTH AND EPILEPSY WARNING

Some small number of people are susceptible to epileptic seizures or loss of consciousness when exposed to certain flashing lights or light patterns that they encounter in everyday life, such as those in certain television images or video games. These seizures or loss of consciousness may occur even if the person has never had an epileptic seizure.

If you or anyone in your family has ever had symptoms related to epilepsy when exposed to flashing lights, consult your doctor prior to using Sega Dreamcast.

In all cases, parents should monitor the use of video games by their children. If any player experiences dizziness, blurred vision, eye or muscle twitches, loss of consciousness, disorientation, any involuntary movement or convulsion, **IMMEDIATELY DISCONTINUE USE AND CONSULT YOUR DOCTOR BEFORE RESUMING PLAY.**

To reduce the possibility of such symptoms, the operator must follow these safety precautions at all times when using Sega Dreamcast:

- Sit a minimum of 6.5 feet away from the television screen. This should be as far as the length of the controller cable.
- Do not play if you are tired or have not had much sleep.
- Make sure that the room in which you are playing has all the lights on and is well lit.
- Stop playing video games for at least ten to twenty minutes per hour. This will rest your eyes, neck, arms and fingers so that you can continue comfortably playing the game in the future.

OPERATING PRECAUTIONS

To prevent personal injury, property damage or malfunction:

- Before removing disc, be sure it has stopped spinning.
- The Sega Dreamcast GD-ROM disc is intended for use exclusively on the Sega Dreamcast video game system. Do not use this disc in anything other than a Sega Dreamcast console, especially not in a CD player.
- Do not allow fingerprints or dirt on either side of the disc.
- Avoid bending the disc. Do not touch, smudge or scratch its surface.
- Do not modify or enlarge the center hole of the disc or use a disc that is cracked, modified or repaired with adhesive tape.
- Do not write on or apply anything to either side of the disc.
- Store the disc in its original case and do not expose it to high temperature and humidity.
- Do not leave the disc in direct sunlight or near a radiator or other source of heat.
- Use lens cleaner and a soft dry cloth to clean disc, wiping gently from the center to the edge. Never use chemicals such as benzene and paint thinner to clean disc.

PROJECTION TELEVISION WARNING

Still pictures or images may cause permanent picture tube damage or mark the phosphor of the CRT. Avoid repeated or extended use of video games on large-screen projection televisions.

SEGA DREAMCAST VIDEO GAME USE

This GD-ROM can only be used with the Sega Dreamcast video game system. Do not attempt to play this GD-ROM on any other CD player; doing so may damage the headphones and/or speakers. This game is licensed for home play on the Sega Dreamcast video game system only. Unauthorized copying, reproduction, rental, public performance of this game is a violation of applicable laws. The characters and events portrayed in this game are purely fictional. Any similarity to other persons, living or dead, is purely coincidental.

TEEOFF™

CONTENTS

STARTING THE GAME.....	2
INTRODUCTION.....	3
MENUS.....	4
DEFAULT CONTROLS.....	6
GAME MODES.....	8
COURSES.....	15
CHARACTERS.....	16
HINTS AND TIPS.....	19



STARTING THE GAME

Never touch the **ANALOG THUMB PAD** or Triggers L/R while turning the Sega Dreamcast power **ON**. Doing so may disrupt the controller initialization procedure and result in malfunction.

1. Insert your **Tee Off™** Sega Dreamcast Specific Disc into your Sega Dreamcast console.
2. Plug your Sega Dreamcast Controller into Controller Port A.

Note: Tee Off™ Golf is a 1-4 player game*. Before turning the Sega Dreamcast power ON, connect the controller or other peripheral equipment into the control ports of the Sega Dreamcast.

3. Tee Off™ utilizes the Jump Pack to enhance the game play experience. If you choose to use a Jump Pack, insert it now in Expansion Socket 2.
4. Switch on the power to your Sega Dreamcast Unit.
5. You will be prompted to select a VMU on which to save your progress in the game. If you do not have a VMU inserted or it does not have adequate blocks to save the game data, you will be alerted but may continue playing. 12 blocks are required to save your settings, 7 blocks to save a game. While saving a game file, never turn OFF the Sega Dreamcast power, remove the memory card or disconnect the controller.

*Purchase additional controllers (sold separately) to play with two or more people.

To return to the title screen at any point during game play, simultaneously press and hold the **A, B, X, Y** and **Start** Buttons. This will cause the Sega Dreamcast to soft-reset the software and display the title screen.

SEGA DREAMCAST HARDWARE UNIT

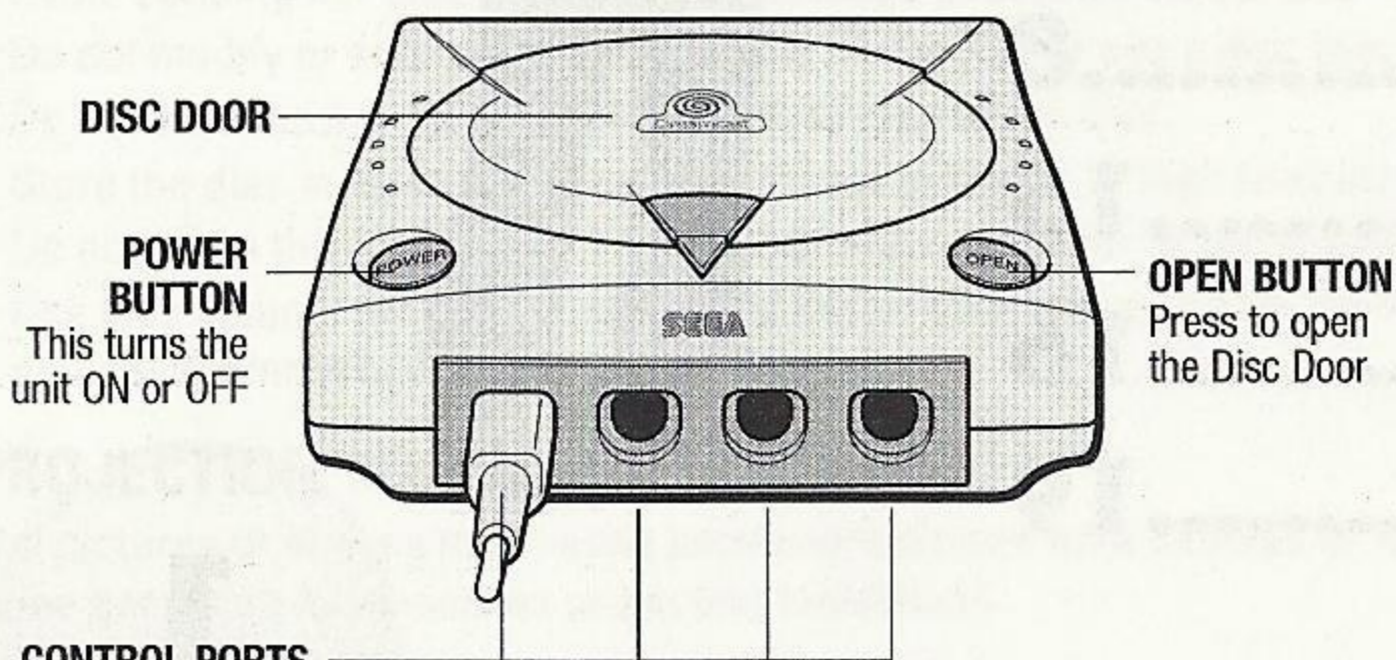

VISUAL MEMORY UNIT (VMU)

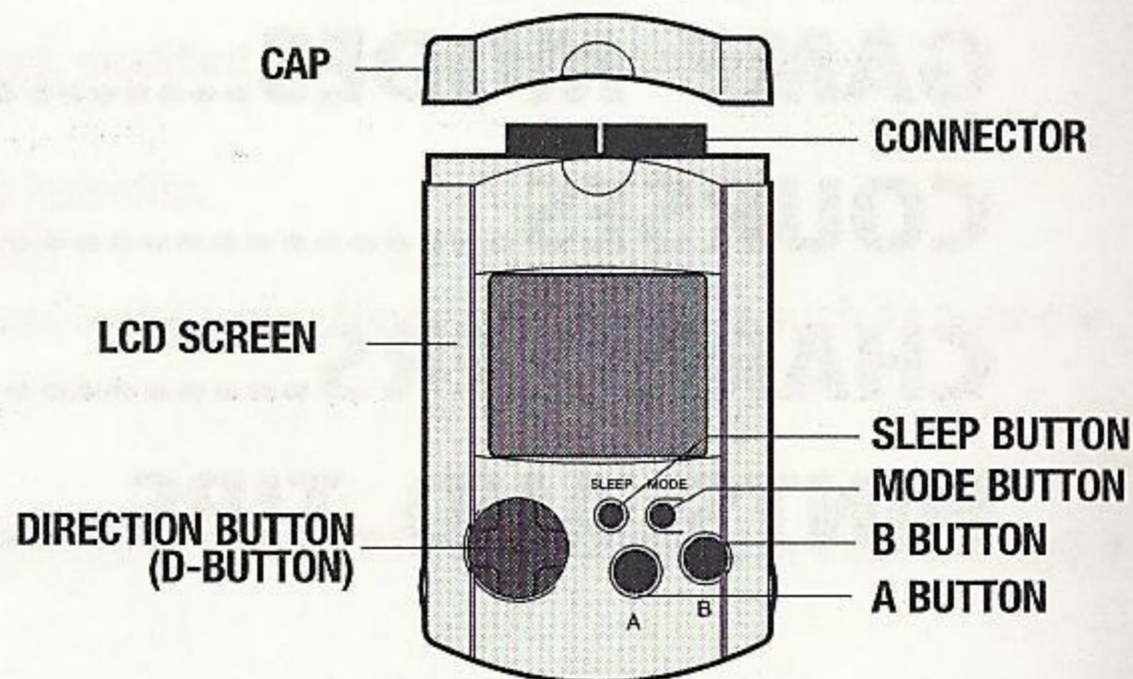

Never disconnect the VMU / VMs while performing a battle or exchanging data when connected to another VMU/VM. Also note that leaving two VMU / VMs connected for a long period of time will considerably shorten the life of the batteries.

INTRODUCTION

The Royal and Ancient game of golf has been around since at least the 15th century. Although its birthplace has been attributed to Scotland, golf has grown and flourished to become a worldwide sport with fans numbering in the millions. Since golf tournaments are held in all corners of the globe, each region lays claim to the "Best Golfer" title. However, there has never been a unification of golfing organizations with the goal of discovering a Master Golfer...until now.

In **TEE OFF™** golf, six fun-filled arcade modes enable you to span the globe vying for world mastery. Select from fifteen different characters and battle through the best courses from Japan, Australia, the US, the UK, and Africa. Select your clubs and control your shot all in hopes to become the world's best golfer!

JUMP PACK

To return to the title screen at any point during game play, simultaneously press and hold the A, B, and Start Buttons. This will cause the Sega Dreamcast to soft-reset the software and display the title screen.

When the Jump Pack/Vibration Pack is inserted into Expansion Socket 1 of the Sega Dreamcast Controller, the Jump Pack/Vibration Pack does not lock into place and may fall out during game play or otherwise inhibit game operation.

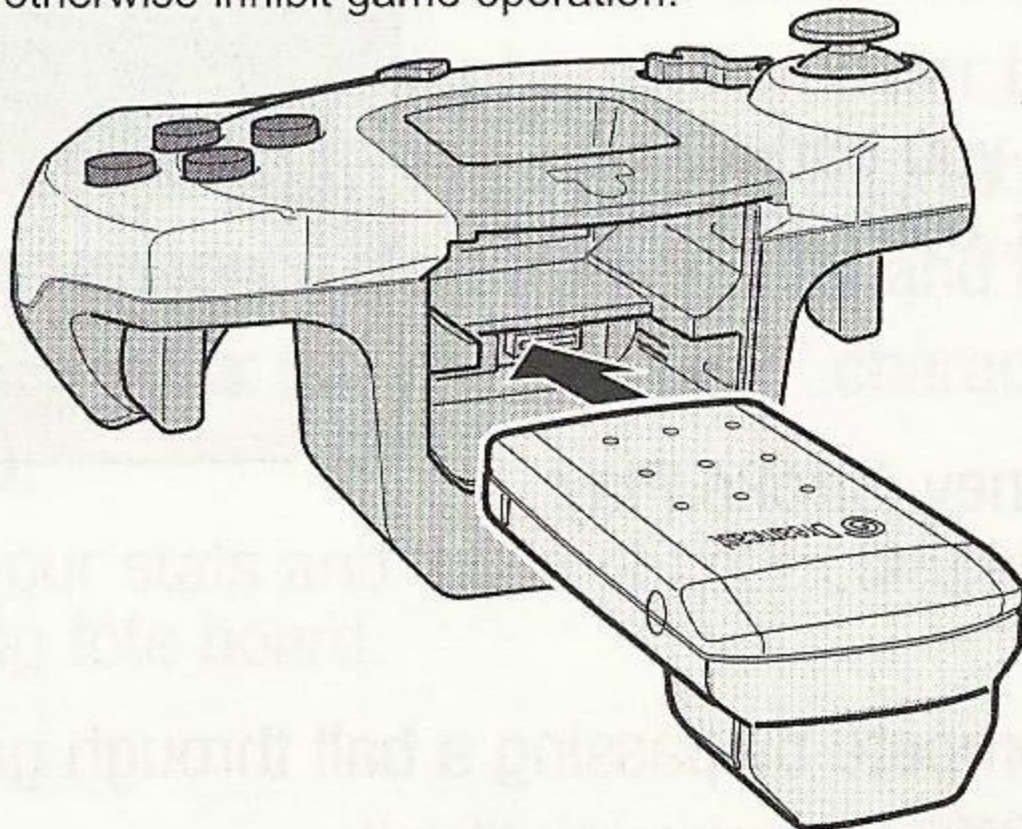

3

MENUS

MENU NAVIGATION:

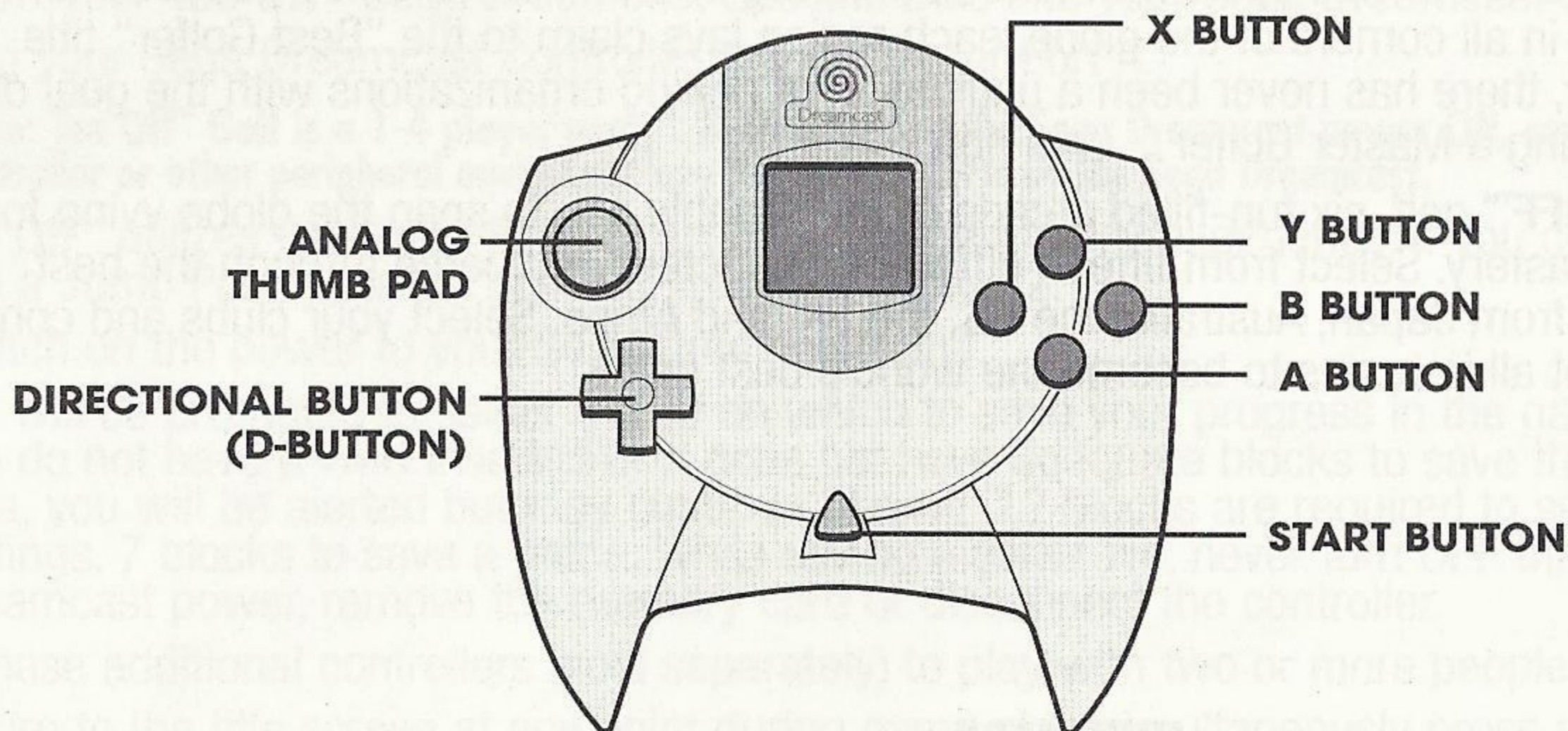

At the title screen, press the **START BUTTON**.

The Main Menu will appear with these choices:

WORLD TOUR: One Player

Compete for the highest total points as you battle through five courses. Unlock new clubs, balls and characters with high scores.

FREE ROUND: One to Four Players.

Composed of three modes – Point Tourney, Stroke Play and Match Play.

GATE BALL: One to Four Players.

A croquet-style game where players compete by passing a ball through gates.

OPTIONS: Visit here first to set up Tee Off™ the way you like it.

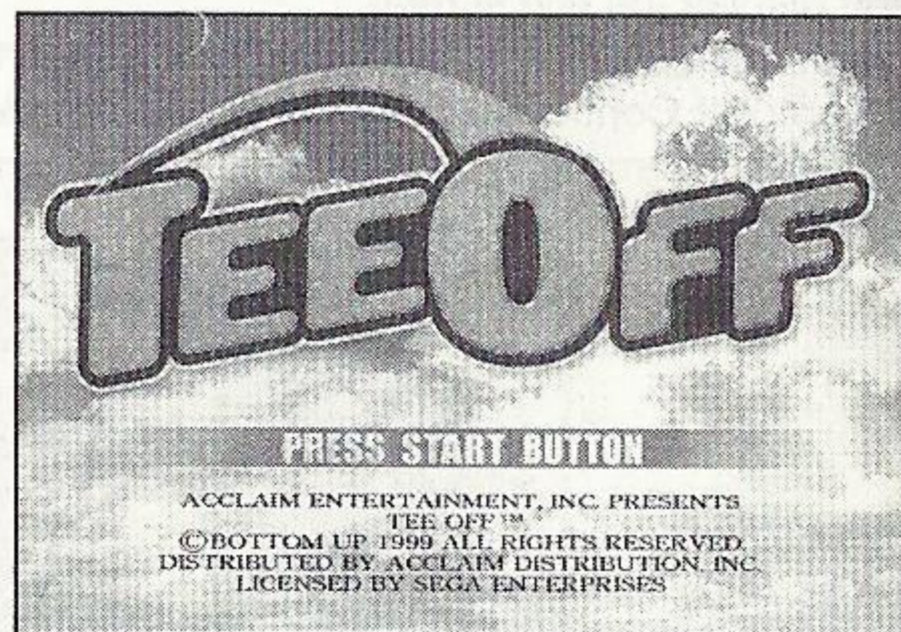

OPTIONS

To set options, press **↑** or **↓** on the **DIRECTIONAL BUTTON** or **ANALOG THUMB PAD** to highlight an option category, and the **A BUTTON** to select that menu. On the menu, highlight an option and press **←** or **→** on the **DIRECTIONAL BUTTON** or **ANALOG THUMB PAD** to cycle settings. When done, press the **B BUTTON** to return to the previous menu.

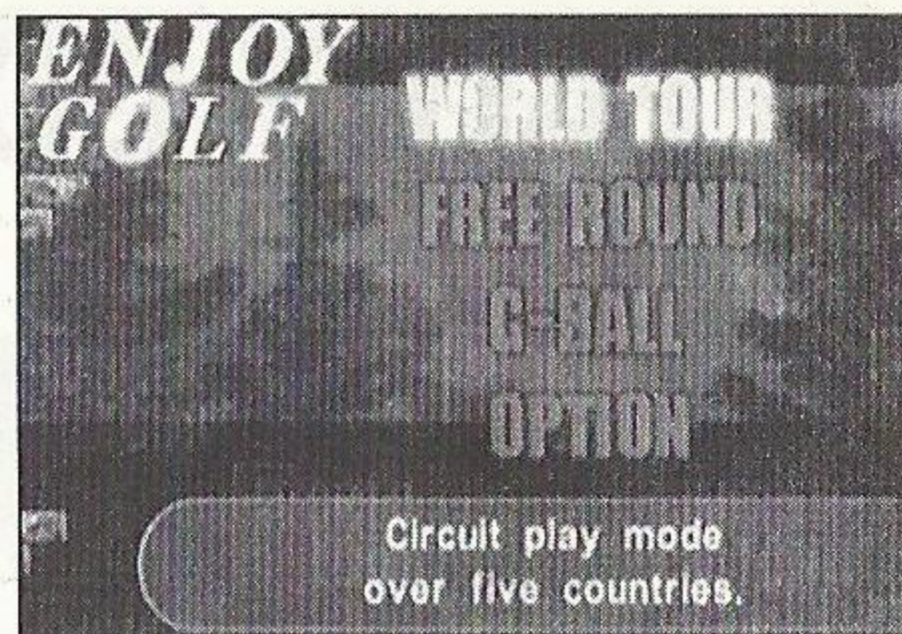

GAME SYSTEM:

GAME LEVEL – Change the difficulty level from 1 (easy) to 5 (hard).

JUMP PACK – Set the vibration intensity from OFF to HIGH. Activate the Jump Pack by pressing the A BUTTON.

SCREEN SAVER – When ON, a screen saver will activate when TEE OFF™ is idle.

BALL CAMERA – Set up the camera viewpoint used when you make your shot.

SOUND:

MONO/STEREO – Select your choice of either sound output.

BGM VOLUME – Use the slider to raise or lower the volume of the background music.

SE VOLUME – Use the slider to raise or lower the volume of the sound effects.

VOICE VOLUME – Use the slider to raise or lower the volume of the characters' voices.

BGM TEST – Select your favorite ditty and listen to your heart's content.

SE TEST – Select a sound effect from the list and hear it play.

VOICE TEST – Hear your favorite TEE OFF™ characters' amusing banter.

SCORE RECORD:

You can check your stats and those of your competition in this all-encompassing tote board.



DEFAULT CONTROLS

SELECT MENU
ITEM/CHARACTER
OPERATION

SHOW GRID LINE/TRAJECTORY LINE

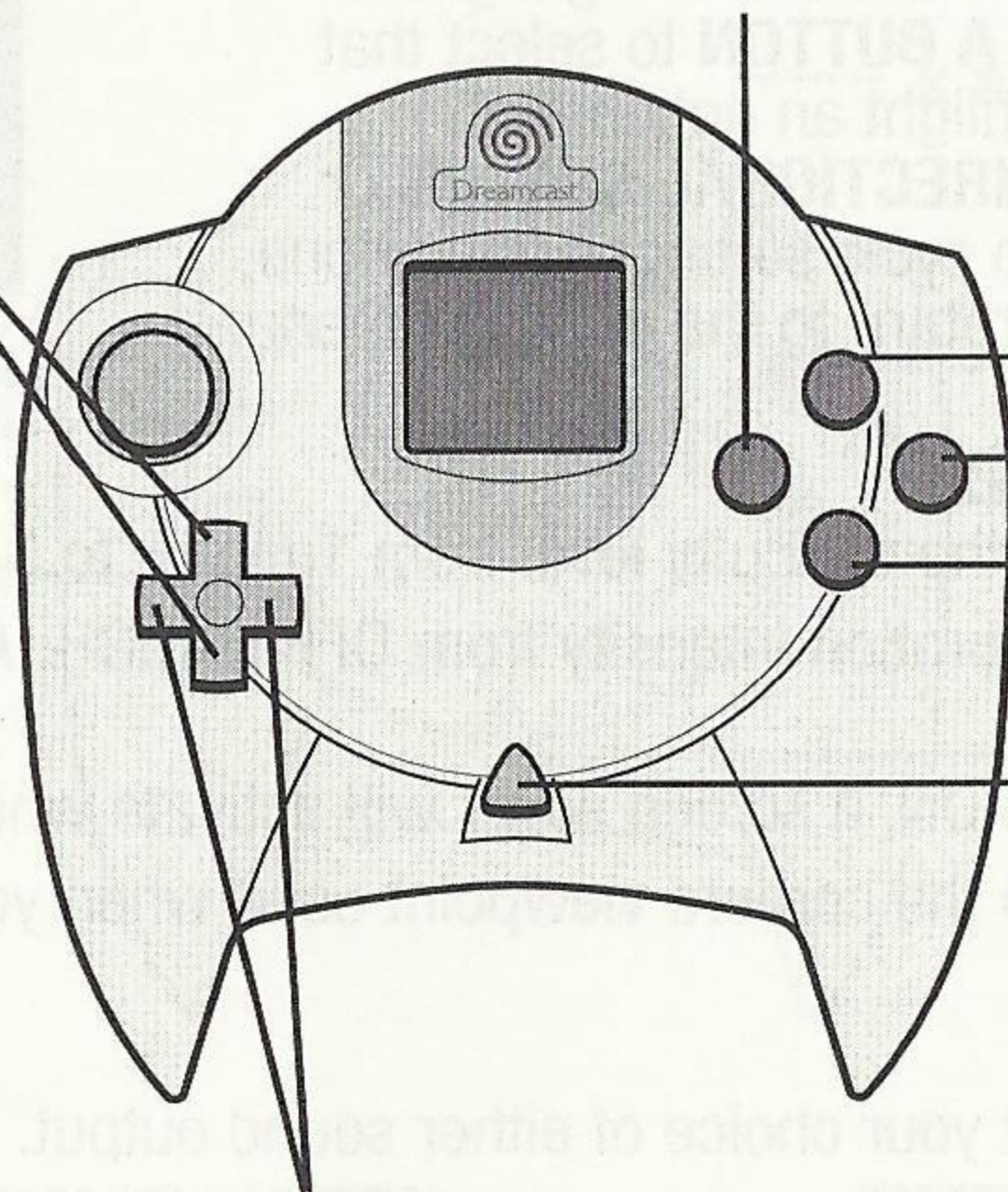

SWITCH CAMERA

CANCEL

SELECT (PROCEED)/
SELECT C GAUGE

SELECT (PROCEED)

SELECT MENU
ITEM/SELECT CLUB

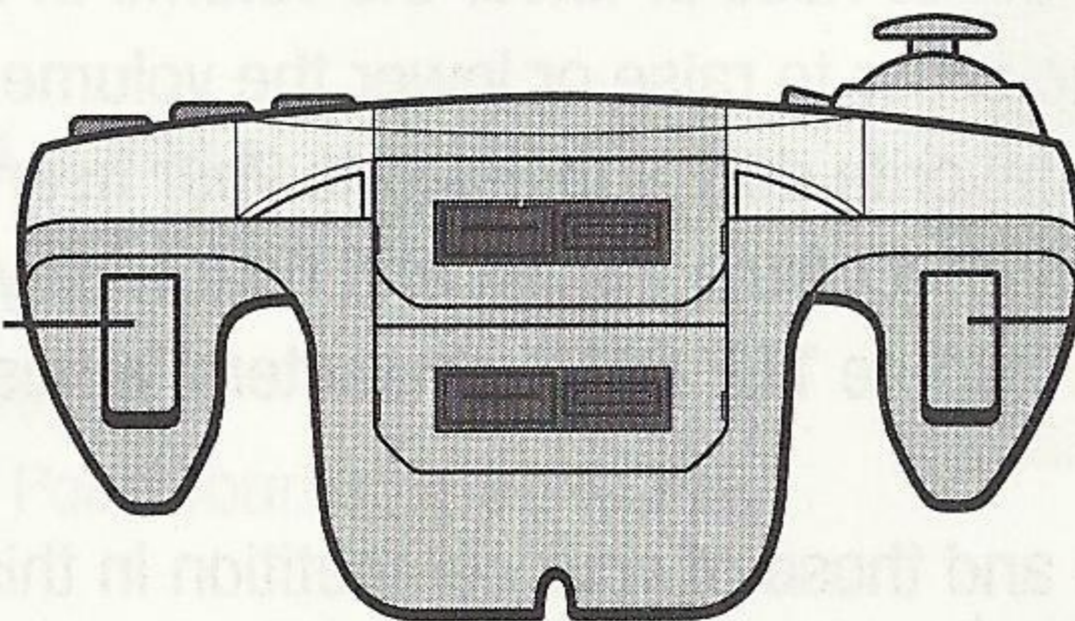

RIGHT TRIGGER
ZOOM-IN
CAMERA

LEFT TRIGGER
ZOOM-OUT CAMERA

6

Never touch the Analog Thumb Pad or Triggers L/R while turning the Sega Dreamcast power ON.

Doing so may disrupt the controller initialization procedure and result in malfunction

GAME SCREEN

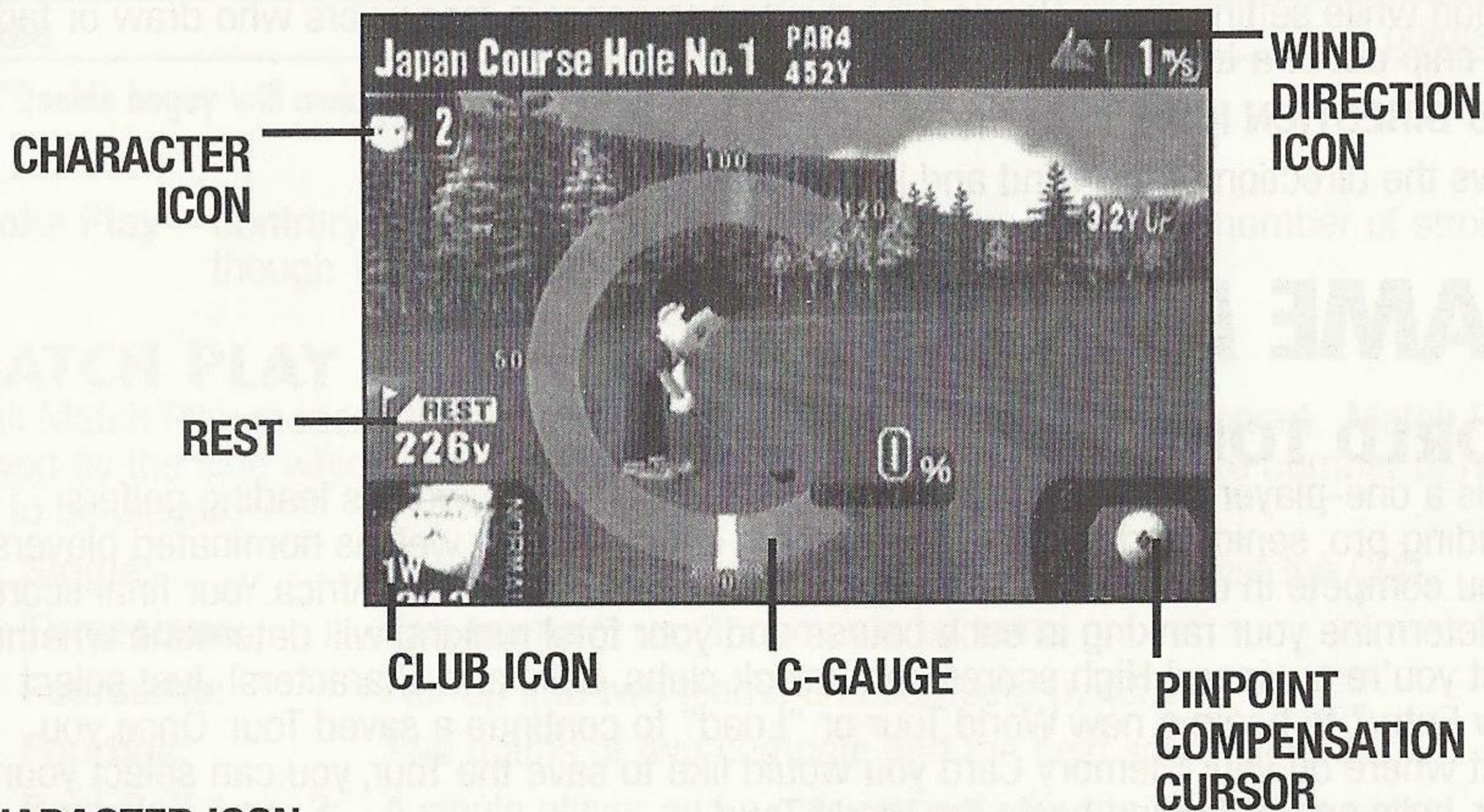

CHARACTER ICON

Your current number of strokes.

REST

The distance to the cup from the ball's current position.

CLUB ICON

Shows the club currently selected.

C-GAUGE

Signifies shot power. Press the **A BUTTON** once to bring up the C-Gauge (you can cancel at this point using the **B BUTTON**). Press the **A BUTTON** again to start the power meter moving. Tap the **A BUTTON** when the meter has reached your desired power level. When the meter reaches the red line under the C-Gauge, tap the **A BUTTON** one last time for an accurate shot (if you miss the red line, you may slice or duff the shot).

PINPOINT COMPENSATION CURSOR

Shows the position where the club will connect with the ball. Adjust this after bringing up the C-Gauge by moving the **ANALOG THUMB PAD**. Hold the cursor in your desired position while setting the C-Gauge. Use this to compensate for players who draw or fade or to chip out of a tough bunker!

WIND DIRECTION ICON

Shows the direction of the wind and its intensity.

GAME MODES

WORLD TOUR

This is a one-player battle. Choose from more than 10 of the world's leading golfers (including pro, senior and amateur tournament champions as well as nominated players) as you compete in courses in Japan, Australia, the US, the UK and Africa. Your final score will determine your ranking in each course and your total ranking will determine whether or not you're a winner! High scores can unlock clubs, balls and characters! Just select "New Entry" to begin a new World Tour or "Load" to continue a saved Tour. Once you select where on your Memory Card you would like to save the Tour, you can select your golfer, balls and clubs and begin the World Tour!

FREE ROUND

This can be played with up to four players. You and your friends (or CPU opponents) can compete in any of these three modes – Point Tourney, Stroke Play and Match Play.

Point Tourney - The player with the highest total score through all the 18 holes becomes a winner!

Here's the point system for Point Tourney:

Albatross	5 points	Par	2 points
Eagle	4 points	Bogey	1 points
Birdie	3 points	Double Bogey and further	0 points

***Double bogey will make a player "GIVE UP".**

Stroke Play – Contrary to Point Tourney, the player with the minimum number of strokes though 18 holes wins!

MATCH PLAY

In all Match Play modes, the object is to win more holes than your opponent. Match Play is won by the side which is ahead by a number of holes greater than the number of holes left to be played.

- Single:** One-on-one match with either a friend or against the CPU.
- Threesome:** Two teams (1 vs. 3) compete by turns.
- Foursome:** Pair up into two teams and compete by turns.
- Fourball:** Two teams of two compete and the best score wins.
- Best Ball 1 vs. 2:** A single player and a pair compete for the best team score.
- Best Ball 1 vs. 3:** A single player and a trio compete for the best team score.

NOTE: You can modify Match Play to make it even harder by invoking the Club Suspension Penalty. This rule allows the winner (or winning team) to make clubs of the other team unavailable for later holes. To put it into effect, select **SPECIAL** under **RULE SELECT** (immediately after selecting your port in **MATCH PLAY**).



GATE BALL

Gate Ball (or G-Ball) is a one to four player game which is very similar in style to croquet. To begin playing, select **START WAR** and press the **A BUTTON** when prompted for the number of contestants. Use the **DIRECTIONAL BUTTON** to select either Team **A** or Team **B** then press the **A BUTTON** to move on to pick your characters, number of balls and handicap.

GATE BALL RULES:

- Pass the ball through the first, second and third gates on the court in order then hit the goal at the center of the court to clear.
- To win Gate Ball, one of the two teams must either clear all of their balls or have the most points at the end of the time limit. One point is awarded for each gate passage.
- The first gate must be passed with one stroke and not go out of bounds or the ball will be called "out" and the first gate must then be repeated. If the ball is called out after the second or third gate, however, it is acceptable.
- If your ball hits another ball while passing through the first gate, your ball will be brought back to the start line and the first gate must be repeated.
- There are certain directions the ball must pass through for each gate indicated with arrows. If you pass the ball through the wrong way, it won't count!
- When determining gate passage or an out-of-bounds call, the center of the ball is the deciding factor. A foul ball will be let outside the nearest out line.
- Hitting an opponent's ball gives you a "Spark Ball" shot. You must hit the Spark Ball more than 10cm or you'll be called for a foul. Use Spark Ball to your advantage; knock your opponents off the court! If your ball is hit by a Spark Ball and passes through a gate, you are awarded that gate, however, a foul is called and your ball will be moved outside the nearest out line.

GATE BALL OPTIONS:

COURT LV – This option changes the level of undulations in the court from 1 (none) to 5 (most).

COM LV – Raise or lower the skill level of the CPU from 1 (weakest) to 5 (strongest).

GAME TIME – Duration of the game in minutes.

SHOT TIME – Time limit for each stroke in seconds.

POINT TIME – When time remaining is less than one minute, the point display ceases.

RULE - Set to ORIGINAL for standard rules game. Change to ARRANGE to modify each of the following:

TAKE POINT - Allows you to snatch an opponent's points by hitting their ball.

MISS POINT- Points will be lost when a foul or out is called.

COMBO POINT- When a single shot touches two or more balls, additional points will be awarded.

OUT POINT- If you knock an opponent's ball out, points are given.

ASSIST POINT- If you knock a teammate's ball through a gate, you'll earn points.

LONG SHOT POINT- If you can get a ball through a gate from long distance, you'll earn additional points.

MIRACLE POINT- Points are awarded when a single shot passes through more than one gate.

GATE BALL GAME SCREEN:

SHOT TIME GAUGE

TIME GAUGE

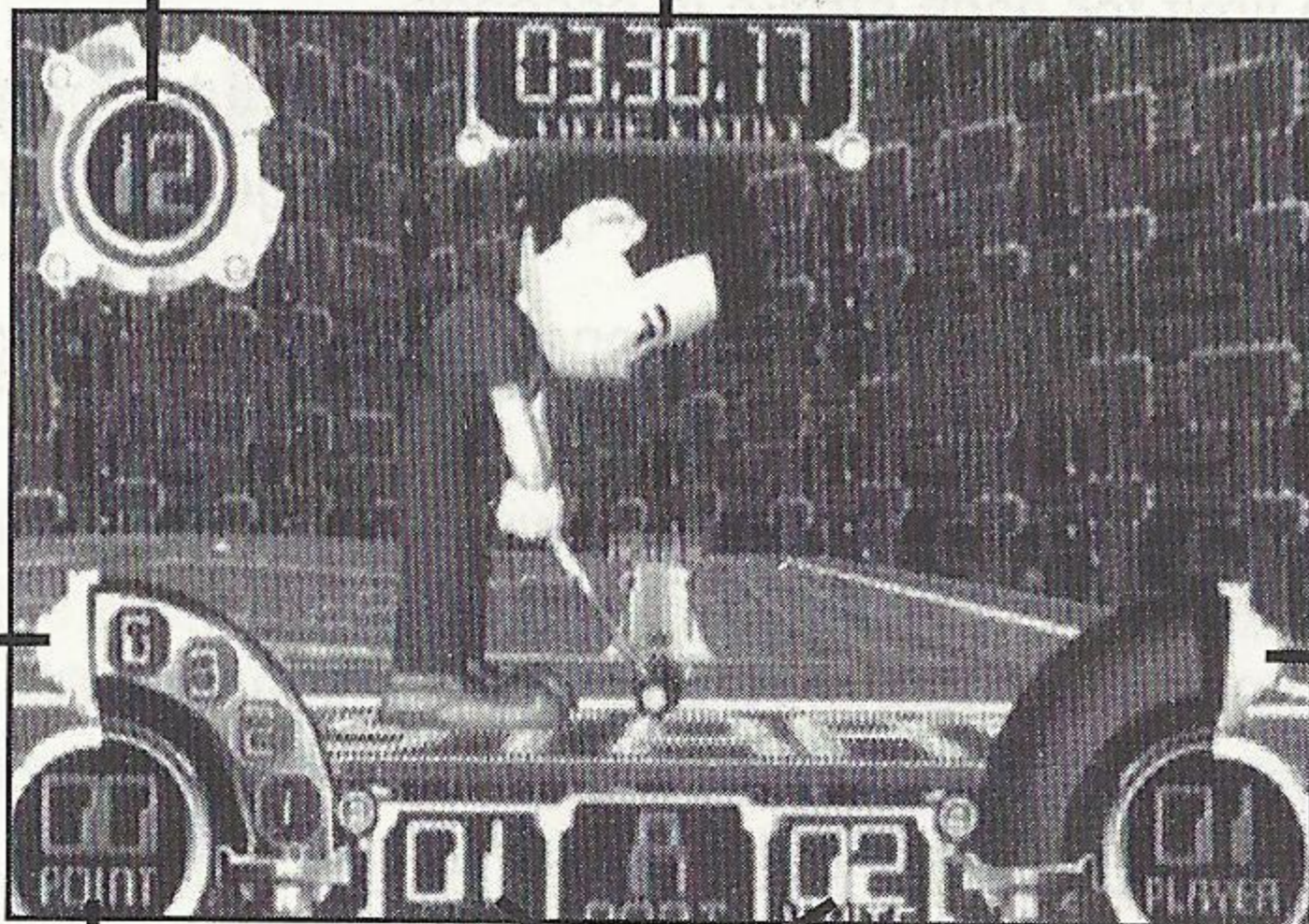

BALL ICON

POWER
GAUGE

CENTER ICON

POINT ICON

SHOT TIME GAUGE

Shows time remaining before shot must be made.

BALL & POINT ICON

Indicates the number of gates passed and points earned.

CENTER ICON

Shows the points for each team and which control port is in operation.

POWER GAUGE

Player number and shot power is displayed here. Start the Power Gauge with the **A BUTTON**. An additional tap on the **A BUTTON** will stop the gauge at the power level you desire.

TIME GAUGE

How much time is left in the round.

GATE BALL CONTROLS:

SELECT
ITEM/CHARACTER
OPERATION

SWITCH TO TOP VIEW

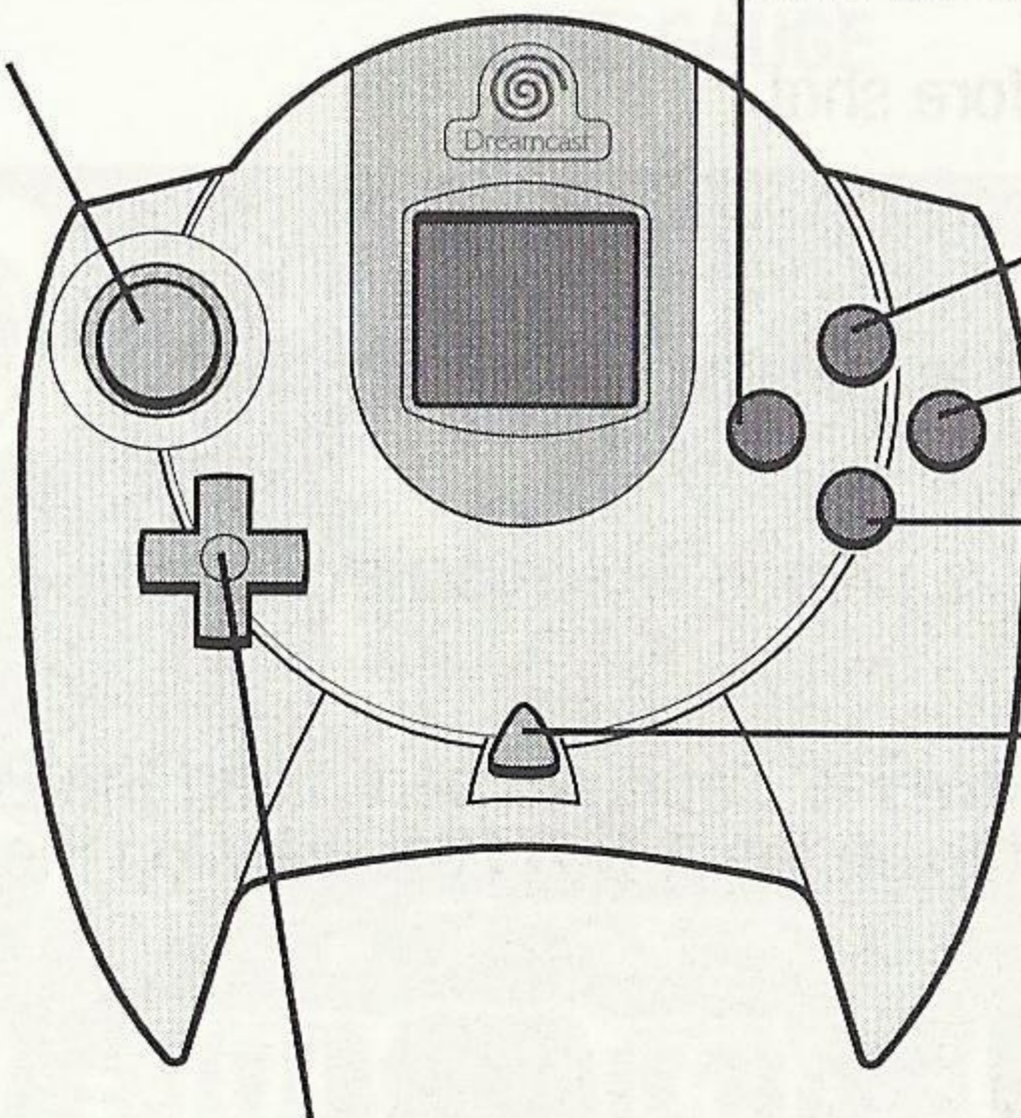

SHOW GRID LINES

CANCEL/HOLD
TO HIDE CHARACTERS

SELECT (PROCEED)/
SELECT POWER GAUGE

PROCEED/PAUSE

SELECT ITEM/MOVE CAMERA
VIEW (UP AND DOWN)

RIGHT TRIGGER
ZOOM-IN CAMERA

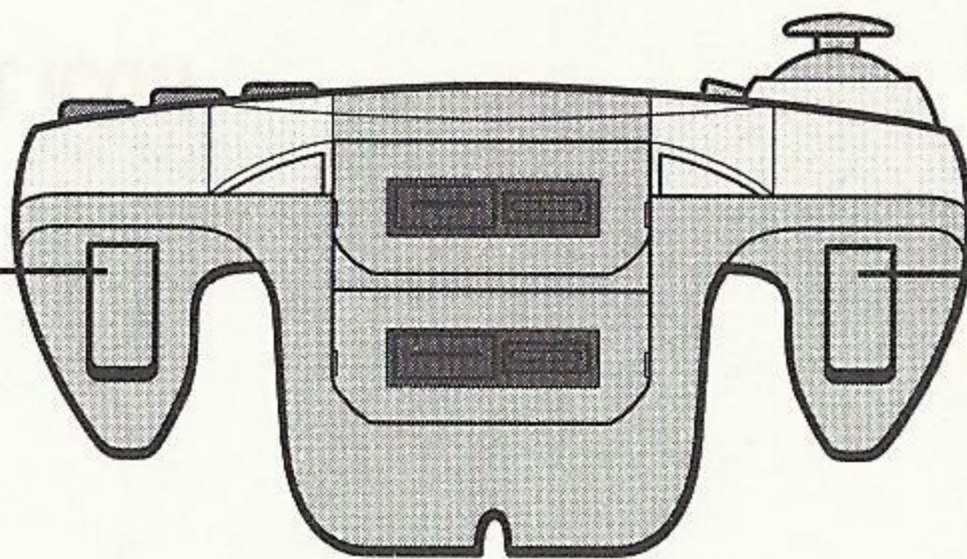

LEFT TRIGGER
ZOOM-OUT CAMERA

COURSES

Your Tee Off™ competition spans the globe! Battle opponents on the following courses:

JAPAN

The most basic of all the courses. Pay special attention to the location of bunkers being careful not to get stuck!

AUSTRALIA

There are a variety of routes through this course. Find the route that best suites your character's abilities.

AFRICA

Keep your wits about you with the pond and river traps on this course. Select your club with care as many holes are blown on the first stroke.

Before you start the golf section of **Tee Off™**, you will see a layout of the course you have selected. Use the left and right triggers to zoom in or out to check the lay of the land before you play!

SCOTLAND

The steep slope, wind and fog make this the most difficult course. Stick to the fairway on this one!

USA

This course is fairly easy if you play the fairway. However, you can earn a higher score by taking the more difficult path.

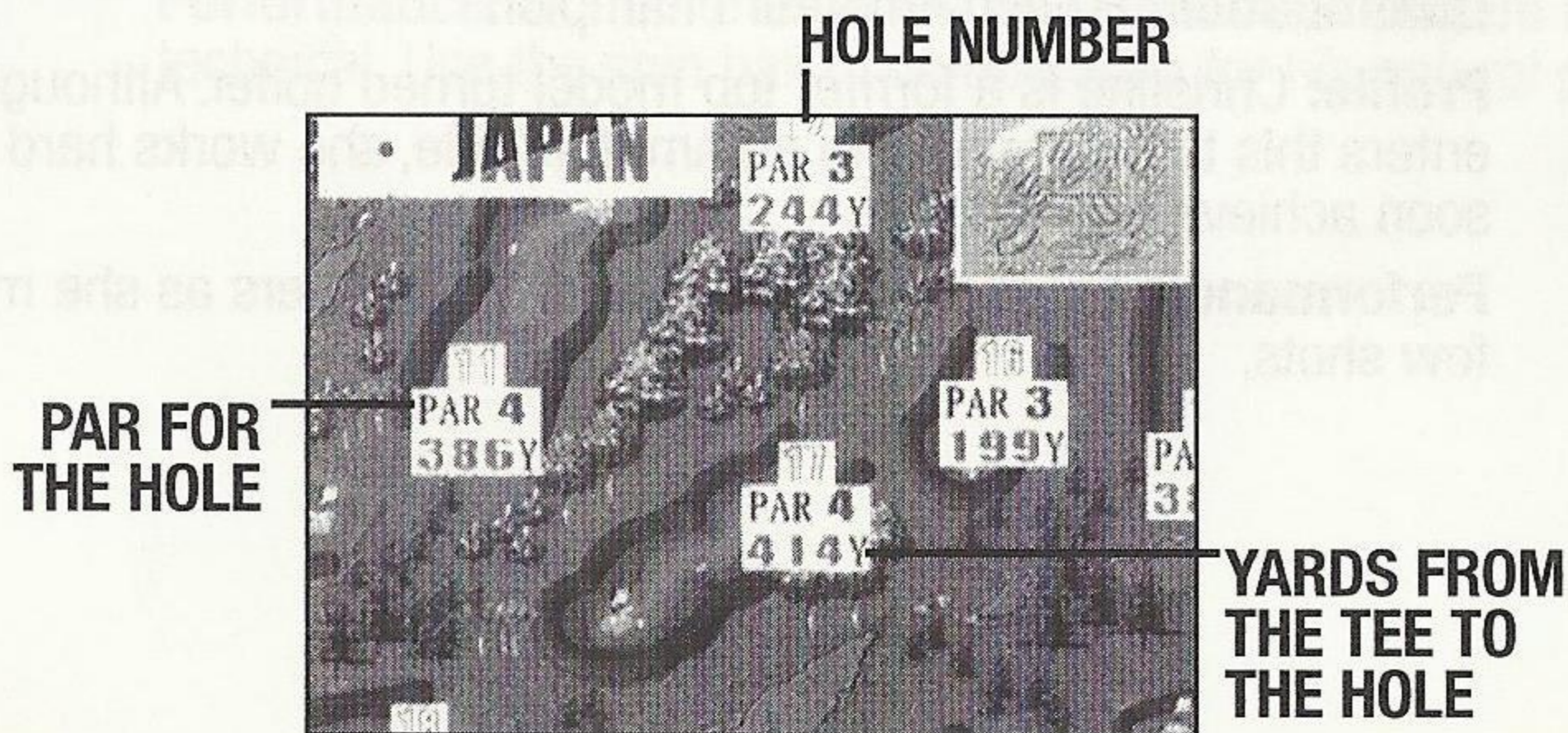

CHARACTERS

These are the characters you start the game with. See if you can unlock others!



AKIO SAITOU

Nationality: Japanese

Age: 26

Height: 5'8"

Qualification: Asian Tour champion

Profile: A cautious player who takes his time with every stroke and achieves reliable results. Akio currently holds the Asian title but hopes to become world class.

Performance: Average. Good for beginners.



CHRISTINE LAMER

Nationality: French

Age: 28

Height: 5'8"

Qualification: French Amateur champion

Profile: Christine is a former top model turned golfer. Although she enters this tournament with an Amateur title, she works hard and will soon achieve a world title.

Performance: Excellent control. Good for beginners as she misses very few shots.



KATHERINE WHITE

Nationality: American

Age: 24

Height: 5'4"

Qualification: American Tour winner

Profile: Catherine can be a very cunning player. She has endured many hardships in her road to becoming the best in America and is now the highest paid player in the States.

Performance: High all-around ability. Suited to advanced players as she has a strong draw ball.



JULIAN CLEMENT

Nationality: Scottish

Age: 16

Height: 5'0"

Qualification: Scotland Amateur champion

Profile: A descendant of European nobility, Julian's father used to be a top golf pro. Talk on the circuit is that he has never recovered from his death.

Performance: Not quite as powerful as the other players but highly technical. Use the spin ball to compensate for his natural pull.

Try to unlock these players from around the world!



**DEBORAH
WHITAKER**



**ELIZABETH
MULER**



**JEENA
SHIREY**



**JOSE
ESTEVEZ**

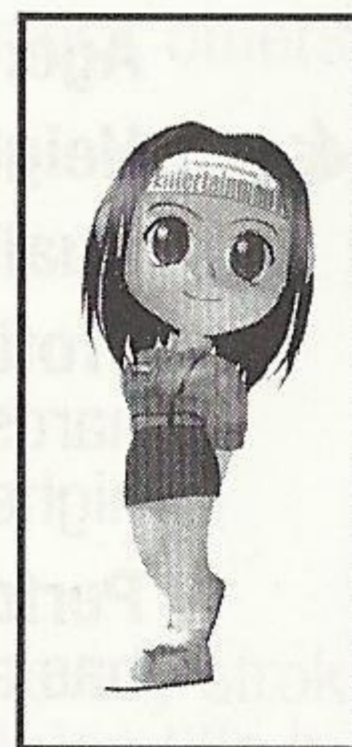

**KIM
SWYONG**



**LEOPOLD
JACKSON**



**MIDORI
TAKAMINE**



**NICK
LANCASTER**

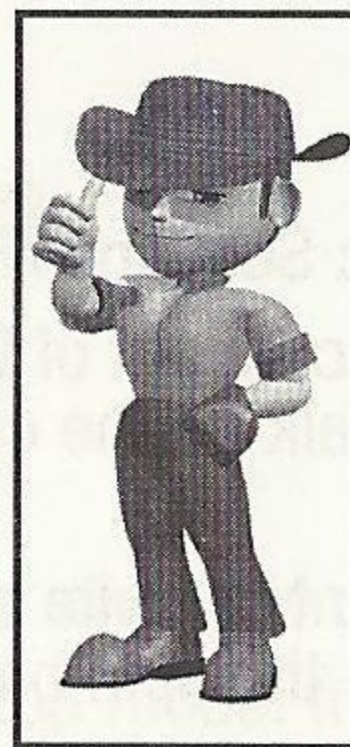

**RANDY
WILDE**

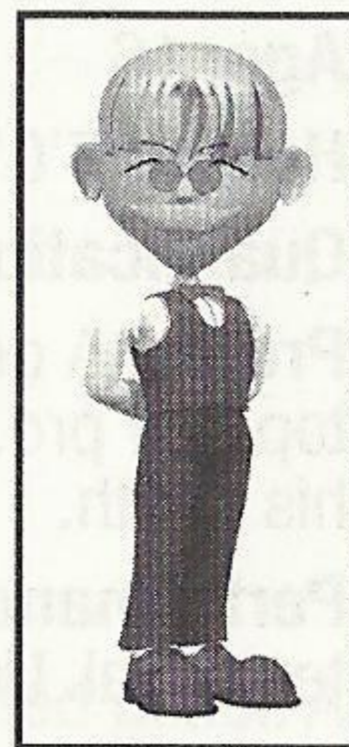

**ROBERT
DUTY**



**WILLIAM
HAUER**

HINTS AND TIPS

- Club weight and ball selection makes a difference! Experiment with the different balls and clubs for the different golfers and different courses and see which combinations work best for your style of play.
- The **X** and **Y BUTTONS** are your friends. Use them. The **X BUTTON** will show you the trajectory and landing spot of your planned shot (you have to account for the wind yourself), while the **Y BUTTON** shows the hole from different camera views, enabling you to see slopes and bunkers up close as you plan your next shot.
- The **LEFT** and **RIGHT TRIGGERS** are also your friends. Use them to zoom in and out and get a better view to help your shot strategy.
- Use the cautious approach to tricky shots. Press UP and DOWN on the **DIRECTIONAL BUTTON** to switch between cautious and normal shots. Pay attention to this indicator because the game will sometimes default to the cautious shot when you're not expecting it.
- Pay attention to the shifting winds! Your shot can be blown way off course and into a hazard. When playing in windy Scotland, adopt the links golf style: Use longer clubs at reduced power to minimize air time and thus wind effect.
- Use the Pinpoint Compensation Cursor (the little red plus on the ball in the lower right of the screen) often. A bit of backspin can make the difference between a 2 foot putt and a 12 foot putt.

NOTES

ACCLAIM® LIMITED WARRANTY

ACCLAIM warrants to the original purchaser only of this ACCLAIM software product that the medium on which this software program is recorded is free from defects in materials and workmanship for a period of ninety (90) days from the date of purchase. This ACCLAIM software program is sold "as is," without express or implied warranty of any kind, and ACCLAIM is not liable for any losses or damages of any kind resulting from use of this program. ACCLAIM agrees for a period of ninety (90) days to either repair or replace, at its option, free of charge, any ACCLAIM software product, postage paid, with proof of date of purchase, at its Factory Service Center. Replacement of the software product, free of charge to the original purchaser (except for the cost of returning the software product) is the full extent of our liability.

This warranty is not applicable to normal wear and tear. This warranty shall not be applicable and shall be void if the defect in the ACCLAIM software product has arisen through abuse, unreasonable use, mistreatment or neglect. THIS WARRANTY IS IN LIEU OF ALL OTHER WARRANTIES AND NO OTHER REPRESENTATIONS OR CLAIMS OF ANY NATURE SHALL BE BINDING ON OR OBLIGATE ACCLAIM. ANY IMPLIED WARRANTIES APPLICABLE TO THIS SOFTWARE PRODUCT, INCLUDING WARRANTIES OF MERCHANTABILITY AND FITNESS FOR A PARTICULAR PURPOSE, ARE LIMITED TO THE NINETY (90) DAY PERIOD DESCRIBED ABOVE. IN NO EVENT WILL ACCLAIM BE LIABLE FOR ANY SPECIAL, INCIDENTAL, OR CONSEQUENTIAL DAMAGES RESULTING FROM POSSESSION, USE OR MALFUNCTION OF THIS ACCLAIM SOFTWARE PRODUCT.

Some states do not allow limitations as to how long an implied warranty lasts and/or exclusions or limitations of incidental or consequential damages so the above limitations and/or exclusions of liability may not apply to you. This warranty gives you specific rights, and you may also have other rights which vary from state to state.

This warranty shall not be applicable to the extent that any provision of this warranty is prohibited by any federal, state or municipal law which cannot be pre-empted.

Repairs/Service after Expiration of Warranty—If your software product requires repair after expiration of the 90-day Limited Warranty Period, you may contact the Consumer Service Department at the number listed below. You will be advised of the estimated cost of repair and the shipping instructions.

Acclaim Hotline/Consumer Service Department (516) 759-7800

TEE OFF™ & Acclaim® & © 1999 Acclaim Entertainment, Inc. All Rights Reserved. Developed by Bottoms Up Interactive. All Rights Reserved. Re-Volt™ & © 1999 Acclaim Entertainment, Inc. All Rights Reserved. Developed by Acclaim Studios London. All Rights Reserved. Marketed by Acclaim. Distributed by Acclaim Distribution, Inc. One Acclaim Plaza, Glen Cove, NY 11542-2777.

ESRB RATING

This product has been rated by the Entertainment Software Rating Board. For information about the ESRB rating, or to comment about the appropriateness of the rating, please contact the ESRB at 1-800-771-3772.

Sega is registered in the US Patent and Trademark Office. Sega Dreamcast and the Dreamcast Swirl, are trademarks of SEGA. Sega of America, P.O. Box 7639, San Francisco, CA 94120. All Rights Reserved. Programmed in Japan. Made and printed in the USA. WARNING: Operates only with NTSC televisions and Sega Dreamcast systems purchased in North and South America (except Argentina, Paraguay and Uruguay). Will not operate with any other televisions or Sega Dreamcast systems. Product covered under one or more of the following U.S. Patents: 5,460,374; 5,525,770; 5,627,895; 5,688,173; 4,442,486; 4,454,594; 4,462,076; Re. 35,839; Japanese Patent No.2870538, (Patents pending in U.S. and other countries); Canada Patent No. 1,183,276. The ratings icon is a trademark of the Interactive Digital Software Association.



LOOK
FOR

REVOLT™

www.acclaim.com

Acclaim Entertainment, Inc., One Acclaim Plaza Glen Cove, NY 11542-2777.

Sega is registered in the US Patent and Trademark Office. Sega Dreamcast, the Dreamcast Swirl, are trademarks of SEGA. Sega of America, P.O. Box 7639, San Francisco, CA 94120. All Rights Reserved. Programmed in Japan. Made and printed in the USA. WARNING: Operates only with VHS televisions and Sega Dreamcast systems purchased in North and South America (except Argentina, Paraguay and Uruguay). Will not operate on any other televisions or Sega Dreamcast systems. Product covered under one or more of the following U.S. Patents: 5,460,374; 5,525,770; 5,627,895; 5,688,173; 4,442,486; 4,454,584; 4,462,076; Re. 35,839; Japanese Patent No.2870538, (Patents pending in U.S. and other countries); Canada Patent No. 1,183,276. The ratings icon is a trademark of the Interactive Digital Software Association.

EVERYONE
TM
E
CONTENT RATED BY
ESRB

Acclaim

SEGA®