

ATCA WING 2™

Dreamcast™



CAPCOM®



T-1222N

WARNINGS Read Before Using Your Sega Dreamcast™ Video Game System

CAUTION

Anyone who uses the Sega Dreamcast should read the operating manual for the software and console before operating them. A responsible adult should read these manuals together with any minors who will use the Sega Dreamcast before the minor uses it.

HEALTH AND EPILEPSY WARNING

Some small number of people are susceptible to epileptic seizures or loss of consciousness when exposed to certain flashing lights or light patterns that they encounter in everyday life, such as those in certain television images or video games. These seizures or loss of consciousness may occur even if the person has never had an epileptic seizure.

If you or anyone in your family has ever had symptoms related to epilepsy when exposed to flashing lights, consult your doctor prior to using the Sega Dreamcast.

In all cases, parents should monitor the use of video games by their children. If any player experiences dizziness, blurred vision, eye or muscle twitches, loss of consciousness, disorientation, any involuntary movement or convulsion, **IMMEDIATELY DISCONTINUE USE AND CONSULT YOUR DOCTOR BEFORE RESUMING PLAY.**

To reduce the possibility of such symptoms, the operator must follow these safety precautions at all times when using the Sega Dreamcast.

- Sit a minimum of 6.5 feet away from the television screen. This should be as far as the length of the controller cable.
- Do not play if you are tired or have not had much sleep.
- Make sure that the room in which you are playing has all the lights on and is well lit.
- Stop playing video games for at least ten to twenty minutes per hour. This will rest your eyes, neck, arms and fingers so that you can continue comfortably playing the game in the future.

OPERATING PRECAUTIONS

To prevent personal injury, property damage or malfunction:

- Before removing the disc, be sure it has stopped spinning.
- The Sega Dreamcast GD-ROM disc is intended for use exclusively on the Sega Dreamcast video game system. Do not use this disc in anything other than a Sega Dreamcast console, especially not in a CD player.
- Do not allow fingerprints or dirt on either side of the disc.
- Avoid bending the disc. Do not touch, smudge or scratch its surface.
- Do not modify or enlarge the center hole of the disc or use a disc that is cracked, modified or repaired with adhesive tape.
- Do not write on or apply anything to either side of the disc.
- Store the disc in its original case and do not expose it to high temperature and humidity.
- Do not leave the disc in direct sunlight or near a radiator or other source of heat.
- Use lens cleaner and a soft dry cloth to clean the disc, wiping gently from the center to the edge. Never use chemicals such as benzene and paint thinner to clean the disc.

PROJECTION TELEVISION WARNING

Still pictures or images may cause permanent picture tube damage or mark the phosphor of the CRT. Avoid repeated or extended use of video games on large-screen projection televisions.

SEGA DREAMCAST VIDEO GAME USE

This GD-ROM can only be used with the Sega Dreamcast video game system. Do not attempt to play this GD-ROM on any other CD player; doing so may damage the headphones and/or speakers. This game is licensed for home play on the Sega Dreamcast video game system only. Unauthorized copying, reproduction, rental, or public performance of this game is a violation of applicable laws. The characters and events portrayed in this game are purely fictional. Any similarity to other persons, living or dead, is purely coincidental.

CAPCOM®

A Special Message from CAPCOM ENTERTAINMENT

Thank you for selecting GIGA WING™ 2 for your Sega Dreamcast. We at CAPCOM ENTERTAINMENT are proud to bring you this new addition to your video game library.

CAPCOM ENTERTAINMENT, INC.

475 Oakmead Parkway, Sunnyvale, CA 94085

© CAPCOM CO., LTD. 2001 ALL RIGHTS RESERVED.

© CAPCOM U.S.A., INC. 2001 ALL RIGHTS RESERVED.

CAPCOM and the CAPCOM LOGO are registered trademarks of CAPCOM CO., LTD. GIGA WING and CAPCOM EDGE are trademarks of CAPCOM CO., LTD.



CONTENTS

A World at War!	2
The Rise of Giga Wing!	4
Pilots & Fighters	5
Sega Dreamcast™	10
Controls	12
Starting a Game	15
Game Screen	16
Rules of Engagement	18
How to Attack	19
Game Modes	20
Option Mode	23
Pause Menu	24
Saving & Loading	25
Stages	26
Capcom Edge	28

CAPCOM EDGE HINT LINE

Hints are available:

1-900-976-EDGE (1-900-976-3343)

\$.99 per minute for 24-hr. pre-recorded information.

\$1.35 per minute for live Game Counselor assistance.

From Canada: 1-900-677-2272 (\$1.35 per minute).

Must be 18 years or older, or have parental permission.

Game Counselors available Monday - Friday 8:30 a.m. - 5:00 p.m.

Pacific Time. This hint line supports games produced by CAPCOM ENTERTAINMENT, INC. only. No hints will be given on our Consumer Service line. You must have a touch-tone phone to use this service.

CAPCOM ON-LINE

<http://www.capcom.com>

Visit our website to see all the great new CAPCOM products or to check out featured games on-line! You can also e-mail us at megamail@capcom.com for technical help or to find out what's new at CAPCOM!

REGISTER ONLINE AT WWW.CAPCOM.COM

GIGAWING 2



A WORLD AT WAR!

The Serbian Republic is a beautiful region in the center of the Eurasian continent, nestled between the Black and Red Seas. For decades it has been one of the most peaceful countries in the Union.

Secretly, though, it's been rumbling with unrest and dissatisfaction. Suddenly, the Republic army erupts in a wide-spread coup against the Union garrison and announces its independence. The Union government is shaken to its roots.

Other Allied Nations make a gesture of assisting the Union's military government. But large-scale military intervention is viewed as unwise as the balance of power shifts daily between the rebels and the Union forces.

The Union government contacts Giga Wing, an elite special forces team, to take the situation in hand. Five young aces take off and head to the Serbian Republic.

It's an entirely new battle!



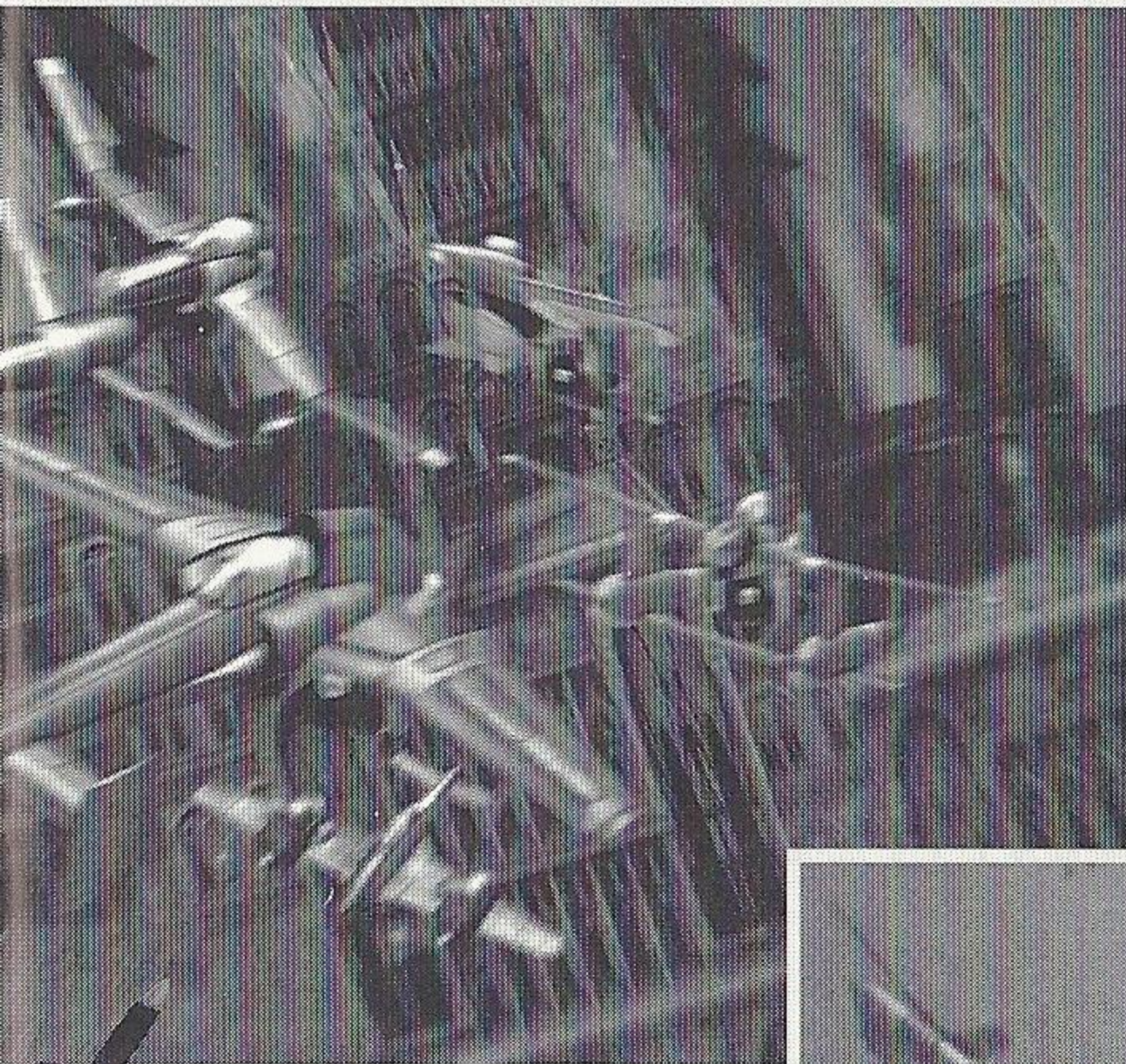



GIGA WING 2

THE RISE OF GIGA WING!

Nothing is impossible for Giga Wing pilots!

Giga Wing is an independent group of air mercenaries originally formed by pilots of the elite Unit 100 Airborne. They played a legendary role in the last war, but have since resigned from the Unit in peacetime.

Since Giga Wing pilots do not pay tribute to any nation and aren't bound by any law, hopeful applicants are not questioned about their past or the history of their airships. The only qualification is excellence!

Only the highest qualified aces are allowed to join. Because of this, Giga Wing pilots display a battle prowess that significantly contributes to successful battles - while engaging the minimum number of pilots.

PILOTS & FIGHTERS

KART

A hero of the previous war. It is said that his squad's performance brought about an early end to the war.

However, Kart's entire team was annihilated in a battle at Lullie Sea, leaving him with no one to lead. After the war, Kart became a mercenary, earning the ominous nickname "Companion Killer."

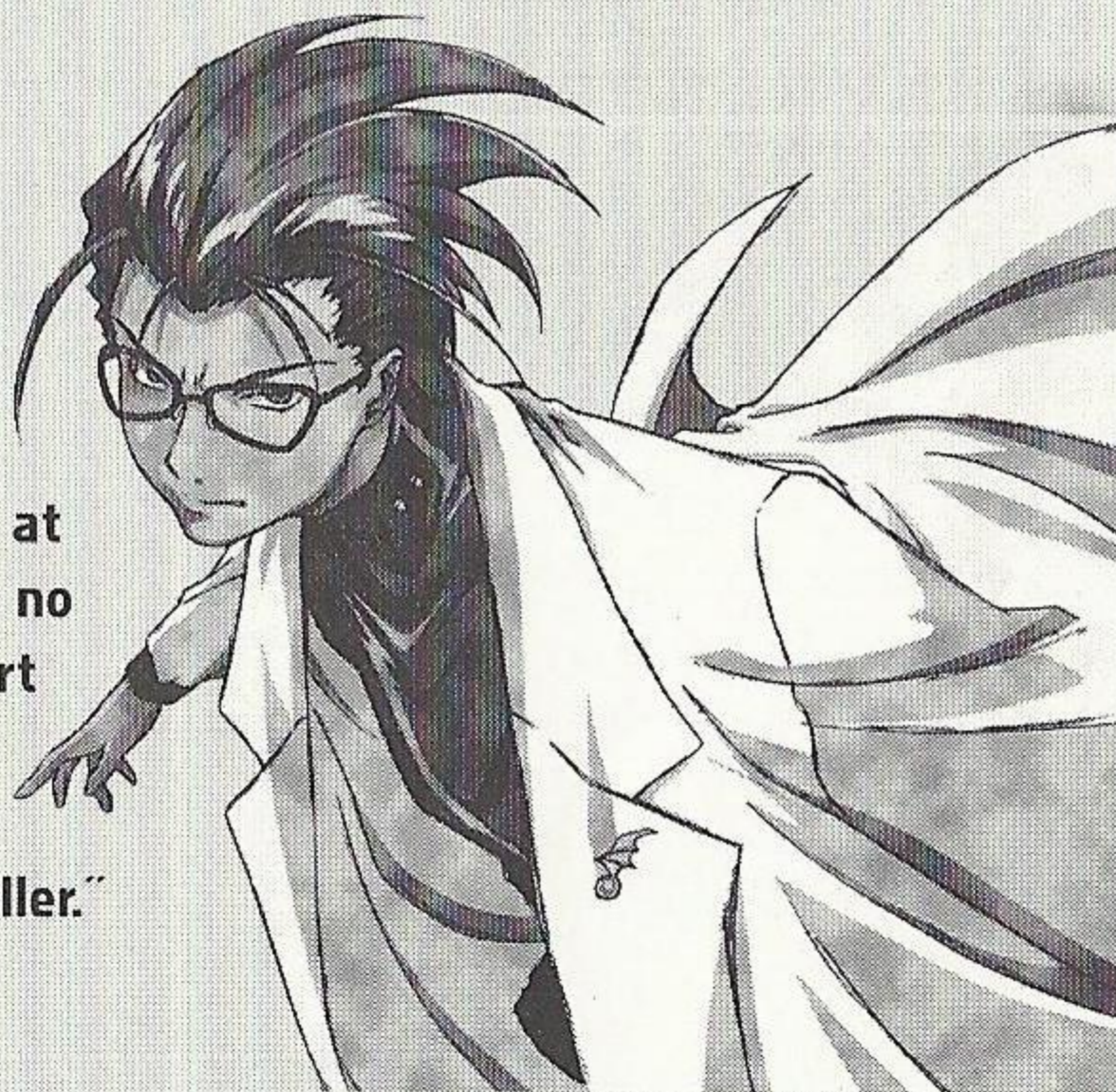

KINGFISHER

An all-around fighter equipped with a wide-range shot.

Speed: Medium (1)

Shot: Forward wide-range gun

Bomber: Spark Bomber

GIGAWING 2

ROMI

A perfect ace pilot whose skill is unrivaled in the team. As a war orphan, Romi was raised in a military institution. While there, she received special education as a fighter pilot.

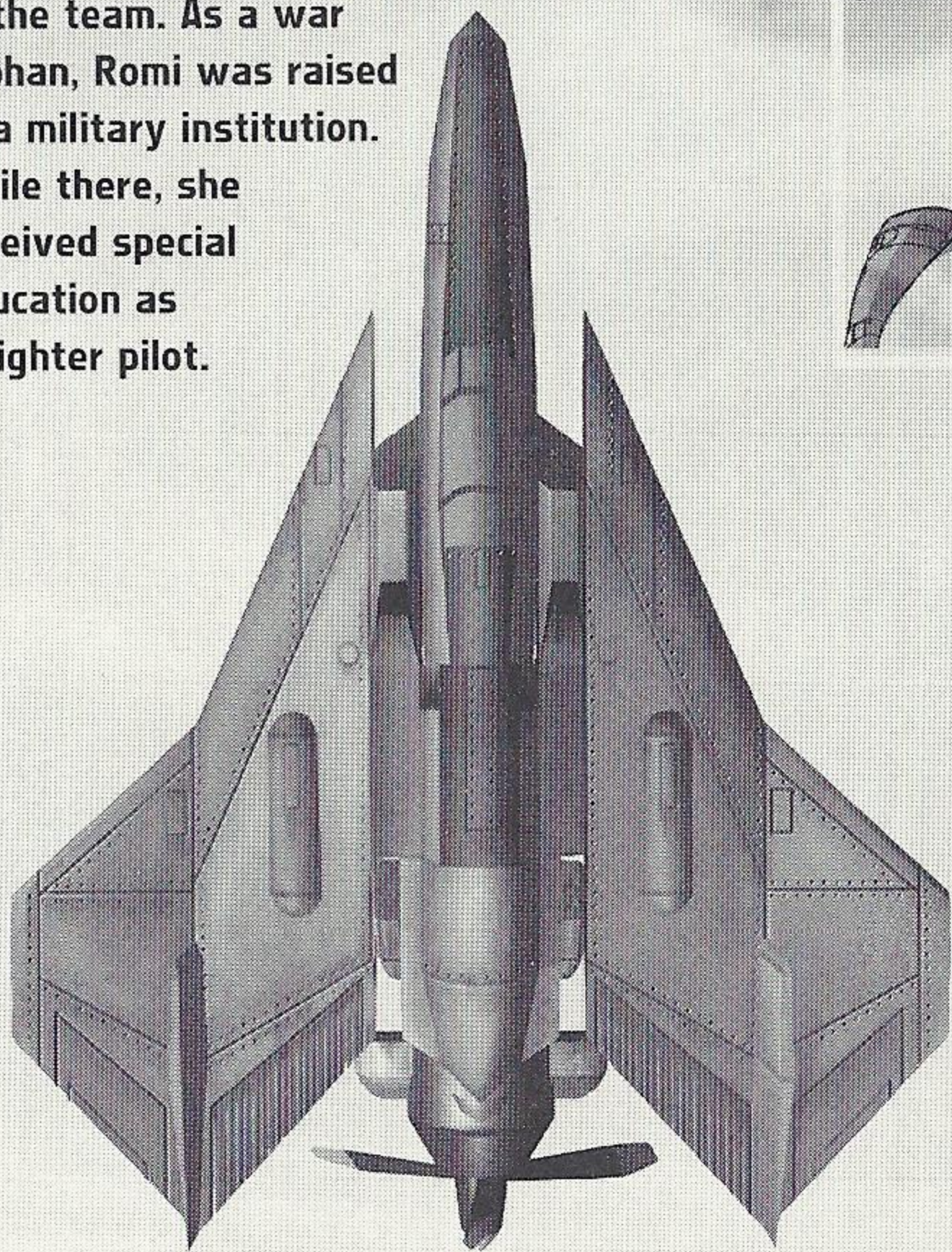

SPARROW

The fastest fighter equipped with a forward collective shot.

Speed: Fastest (5)
Shot: Forward collective gun
Bomber: Wing Bomber (R)

LIMI

The last survivor of an ancient Serbian family. Limi keeps alive the legend of the family's powerful canon.

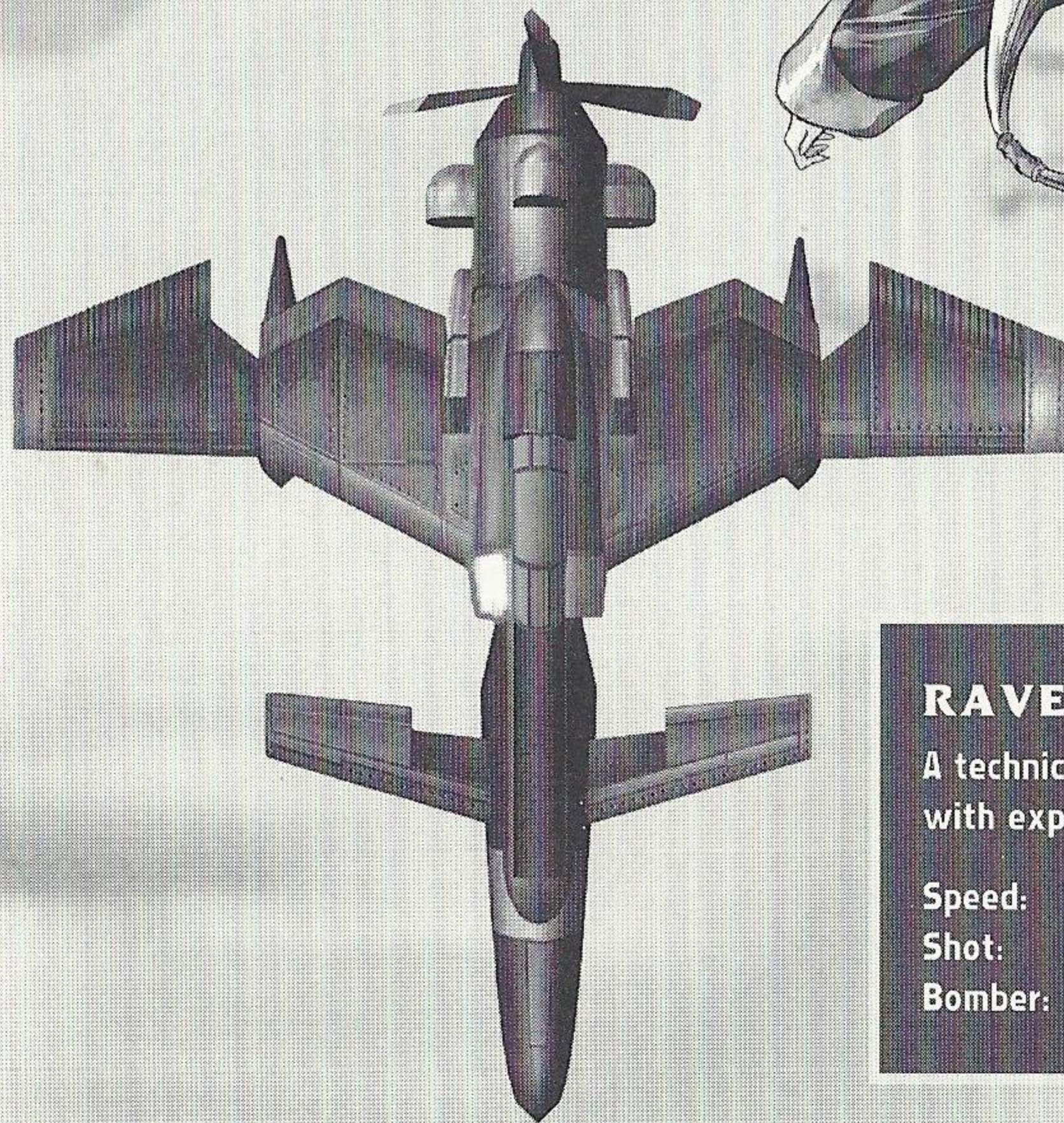

RAVEN

A technical fighter equipped with explosive shot.

Speed: Fast (3)

Shot: Forward explosive gun

Bomber: Wing Bomber (L)

GIGAWING 2

CHERY

Officially registered as one of the replicoids (artificial soldiers) mass-produced during the war, in reality Chery is an original artificial human. She was found in a sanctuary.

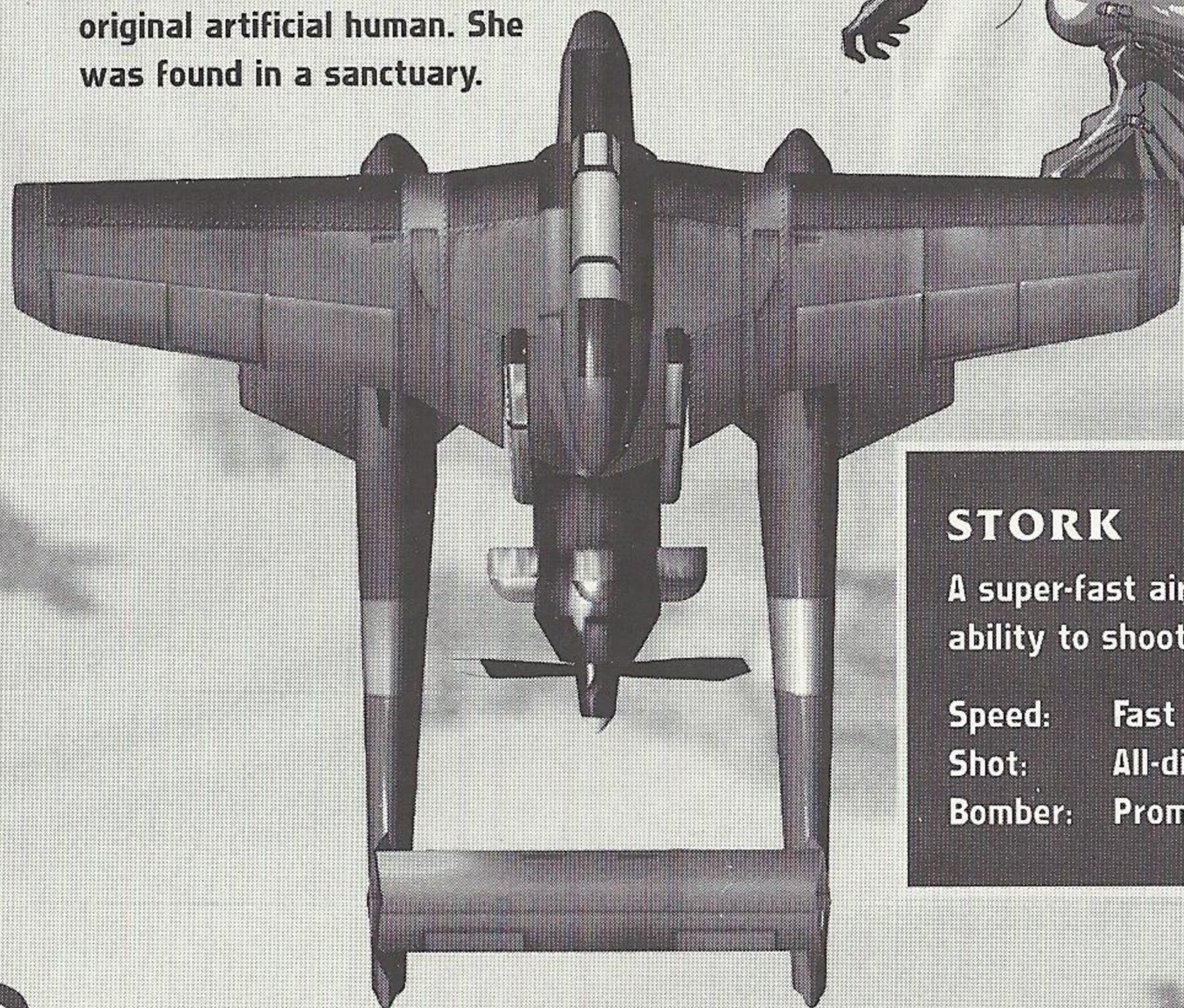

STORK

A super-fast aircraft with the ability to shoot in all directions.

Speed: Fast (4)

Shot: All-direction homing gun

Bomber: Prominence Bomber

RALUGO

Ralugo once fought for independence for his family in Serbia, but lost to the huge power of the empire. After living as a drifter, he has decided to become a Giga Wing mercenary.

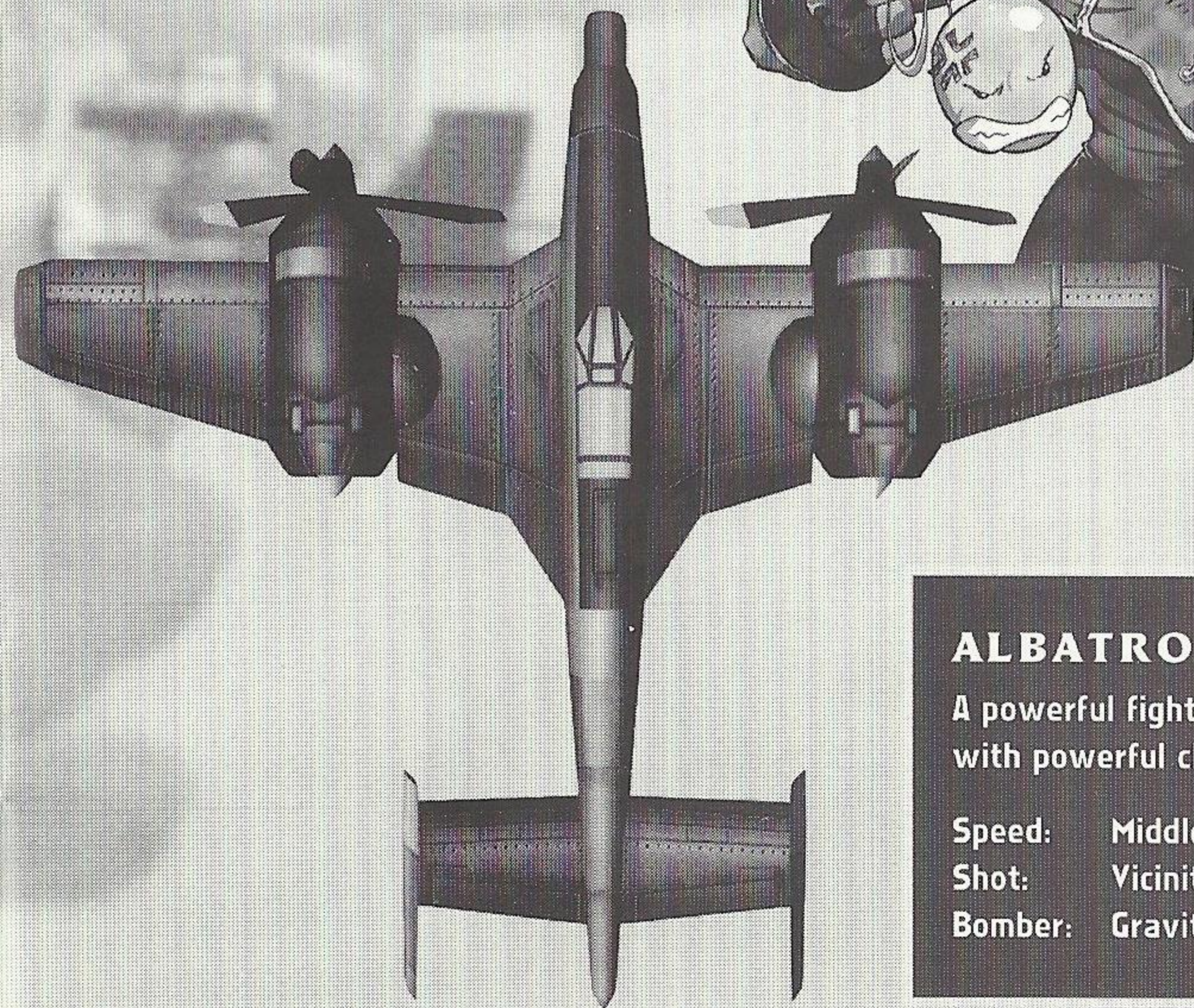

ALBATROSS

A powerful fighter equipped with powerful close-range shot.

Speed: Middle (2)
Shot: Vicinity Bomb
Bomber: Gravity Bomber

GIGA WING 2

SEGA DREAMCAST™

SEGA DREAMCAST HARDWARE UNIT

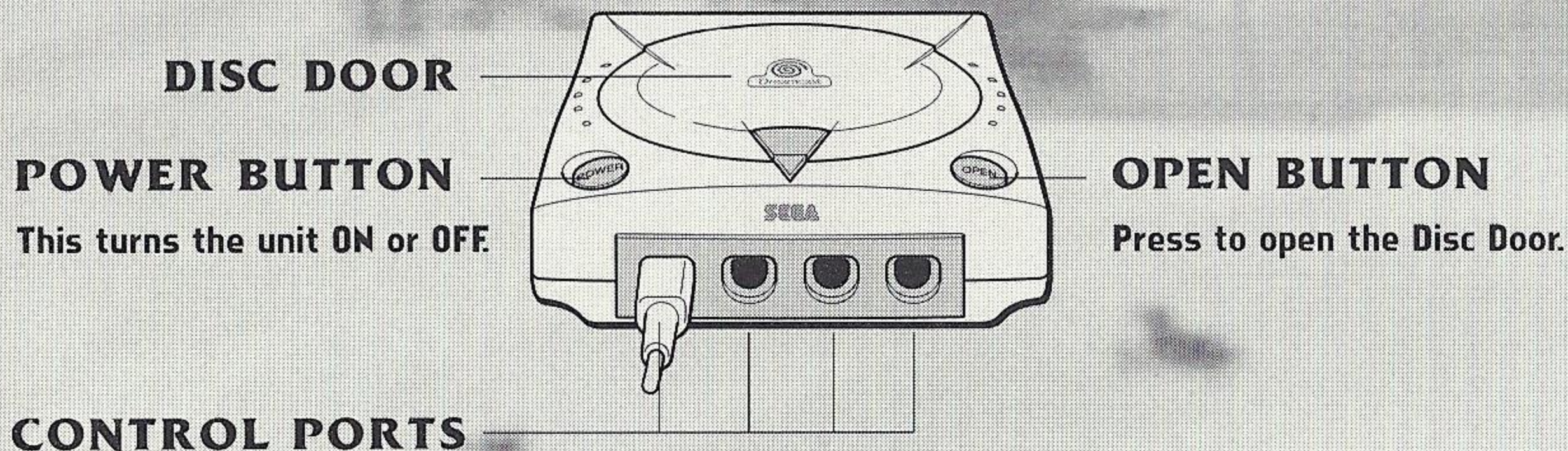

CONTROL PORTS

Use these ports to connect the Sega Dreamcast™ Controller or other peripheral equipment. From left to right are **Control Port A**, **Control Port B**, **Control Port C**, and **Control Port D**. Before turning the Sega Dreamcast power ON, connect the Sega Dreamcast controller(s) or other peripheral equipment into the control ports. Use Control Ports A, B, C and D to connect controllers for players 1 to 4 respectively.

- **GIGA WING 2** is a 1-to-4 player game.
- To return to the Title screen at any point during game play, simultaneously press and hold the A, B, X, Y and Start buttons. This will cause the Sega Dreamcast to soft-reset the software.
- Purchase additional controllers (sold separately) to play with two or more people.

SEGA DREAMCAST VISUAL MEMORY UNIT (VMU)

To automatically save score rankings, option settings and other game information, insert a Visual Memory Unit (VMU) into Expansion Slot 1 of the controller in Control Port A **BEFORE** turning on the Sega Dreamcast.

Note: While saving a game file, never turn **OFF** the Sega Dreamcast power, remove the memory card or disconnect the controller.

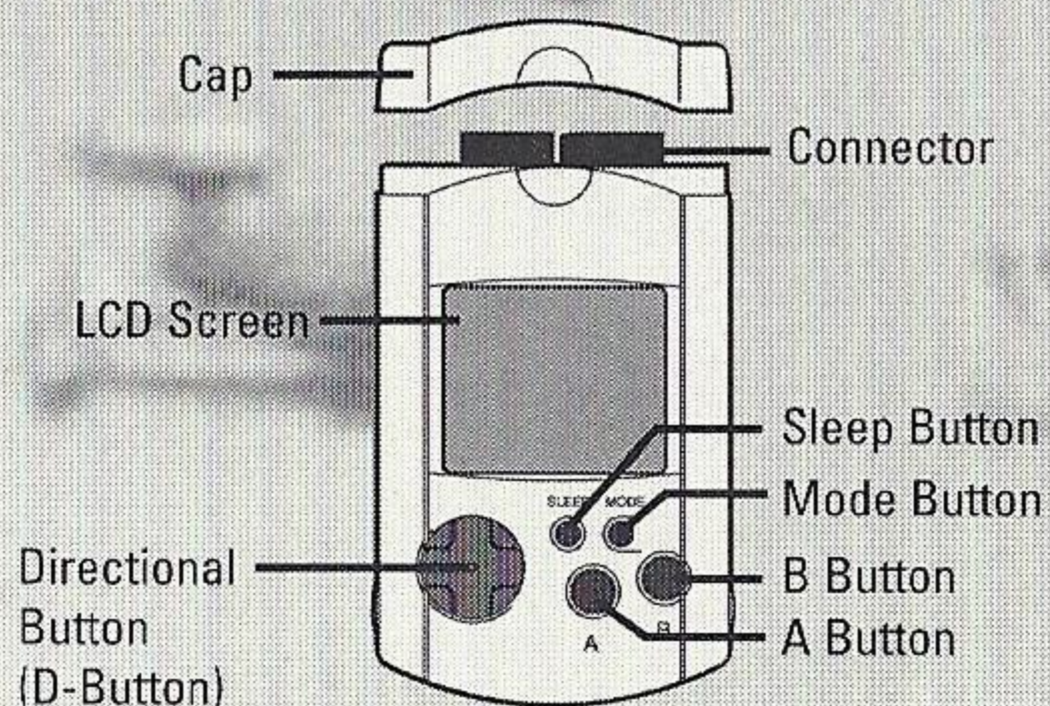

GIGA WING 2

CONTROLS

• The button assignments on pages 13-14 are the defaults.

You can change them in Option Mode. (See page 23.)

- **GIGA WING 2** is a 1-to-4 player game. Connect controllers or other peripheral equipment before turning on the Sega Dreamcast.
- Never touch the Analog Thumb Pad or Triggers L/R while turning the Sega Dreamcast power ON. Doing so may disrupt the controller initialization procedure and result in malfunction. If the Analog Thumb Pad or Triggers L/R are accidentally moved while turning the Sega Dreamcast power ON, immediately turn the power OFF and then ON again, making sure not to touch the controller.
- To return to the Title screen at any point during game play, simultaneously press and hold the A, B, X, Y and Start buttons. This will cause the Sega Dreamcast to soft-reset the software.

SEGA DREAMCAST JUMP PACK™

GIGA WING 2 supports the Jump Pack vibration peripheral. When inserted into the Expansion Slot of a Sega Dreamcast controller or compatible peripheral equipment, the Jump Pack provides a vibration effect that can considerably enhance the gameplay experience.

The Jump Pack cannot be used with the Arcade Stick.

Note: When inserted into Expansion Slot 1 of the Sega Dreamcast controller, the Jump Pack connects, but does not lock. If the controller is jarred, the Jump Pack may fall out during gameplay or otherwise inhibit game play operation.

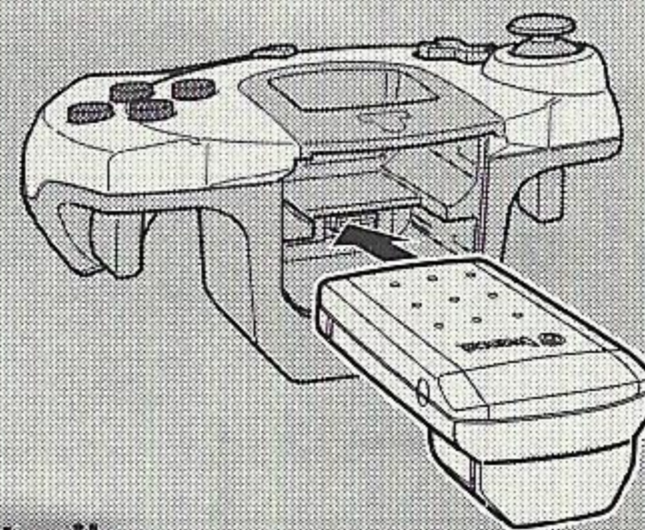

SEGA DREAMCAST CONTROLLER

OVERHEAD VIEW

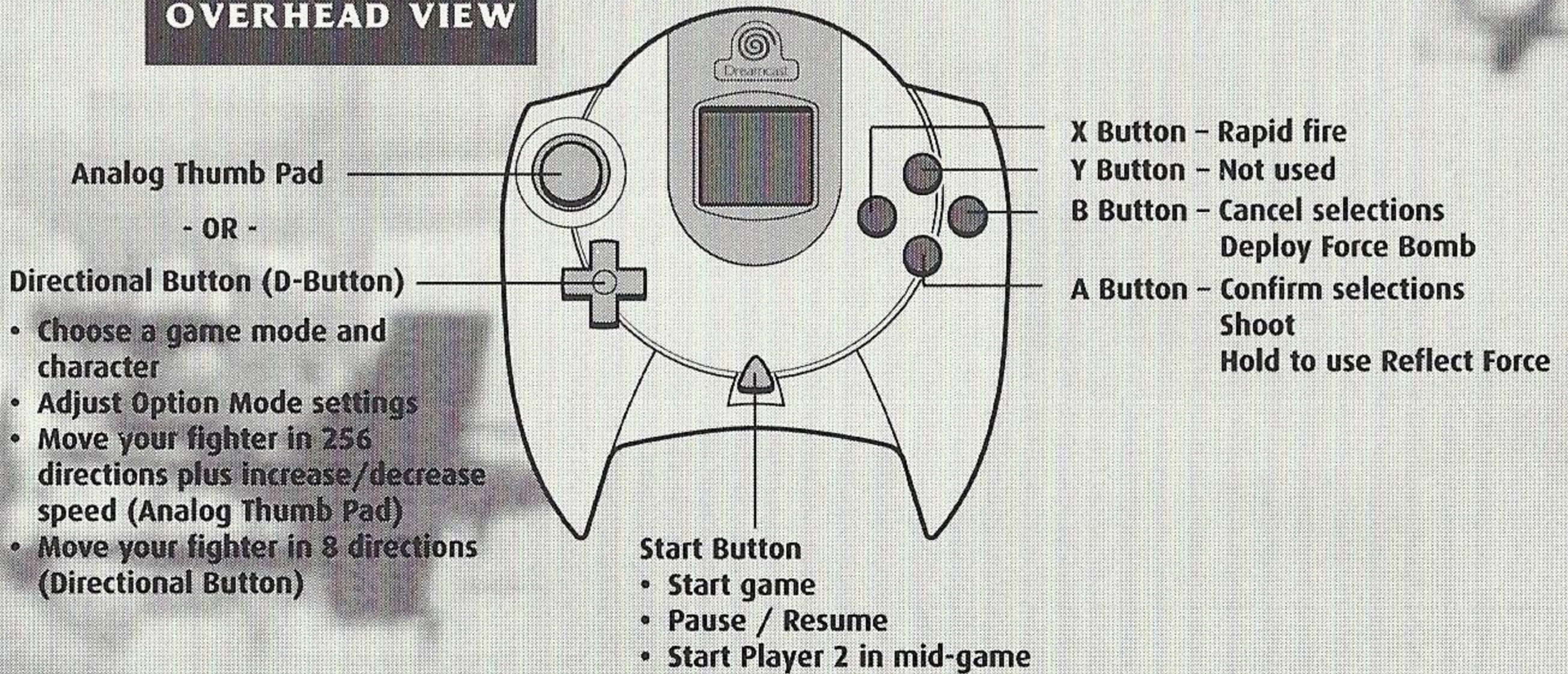

FORWARD VIEW

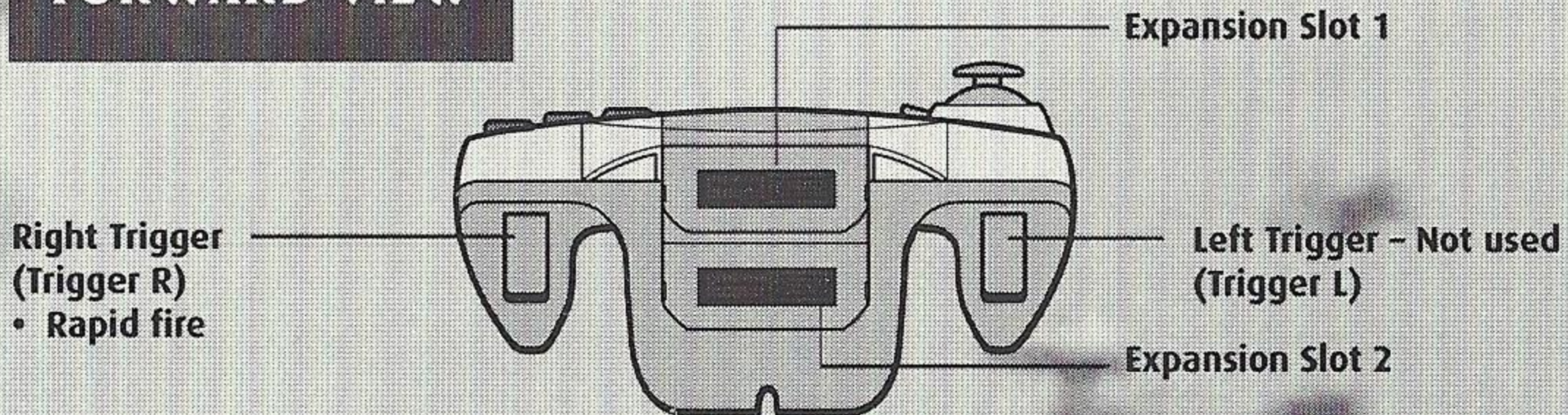

GIGAWING 2

SEGA DREAMCAST ARCADE STICK

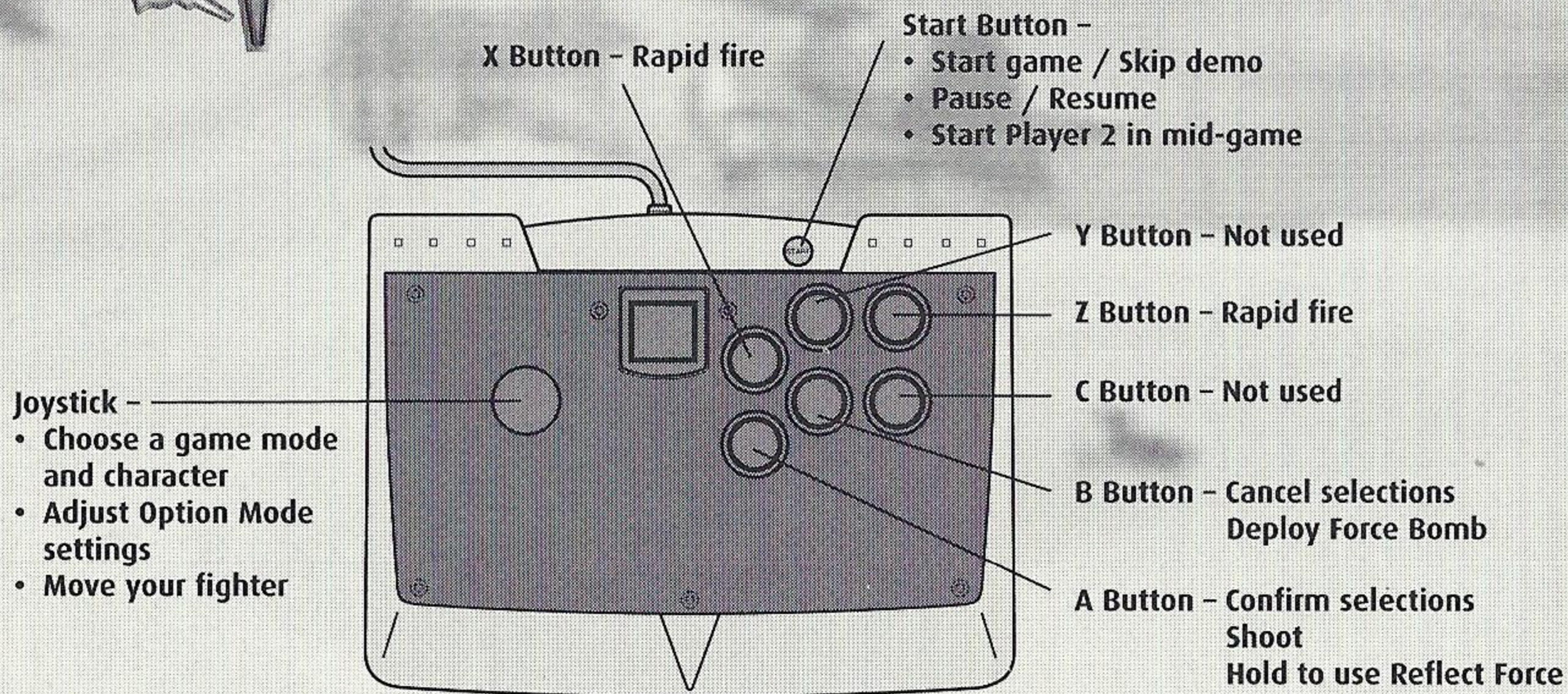

- The button assignments on pages 13-14 are the defaults. You can change them in Option Mode. (See page 23.)
- To return to the Title screen at any point during game play, simultaneously press and hold the A, B, X, Y and Start buttons. This will cause the Sega Dreamcast to soft-reset the software.

STARTING A GAME

Press the Start Button at the Title screen to display the Main Menu. To make your selections, use the Directional Button/Joystick to choose and press the A Button to confirm.

- Before starting play, set game options by selecting **OPTION**. (See page 23 for Option Mode features.)
- Select a game mode by choosing **ARCADE MODE** or **SCORE ATTACK MODE**. (See page 20.)
- Choose your pilot from 5 characters.
- Choose your Reflect Type (see page 19).
- Watch the game demo (or cancel by pressing the B Button).
- **GIGA WING 2 combat begins!**



GIGAWING 2

GAME SCREEN

High Score

Total Score

Fighters

Force Bomb

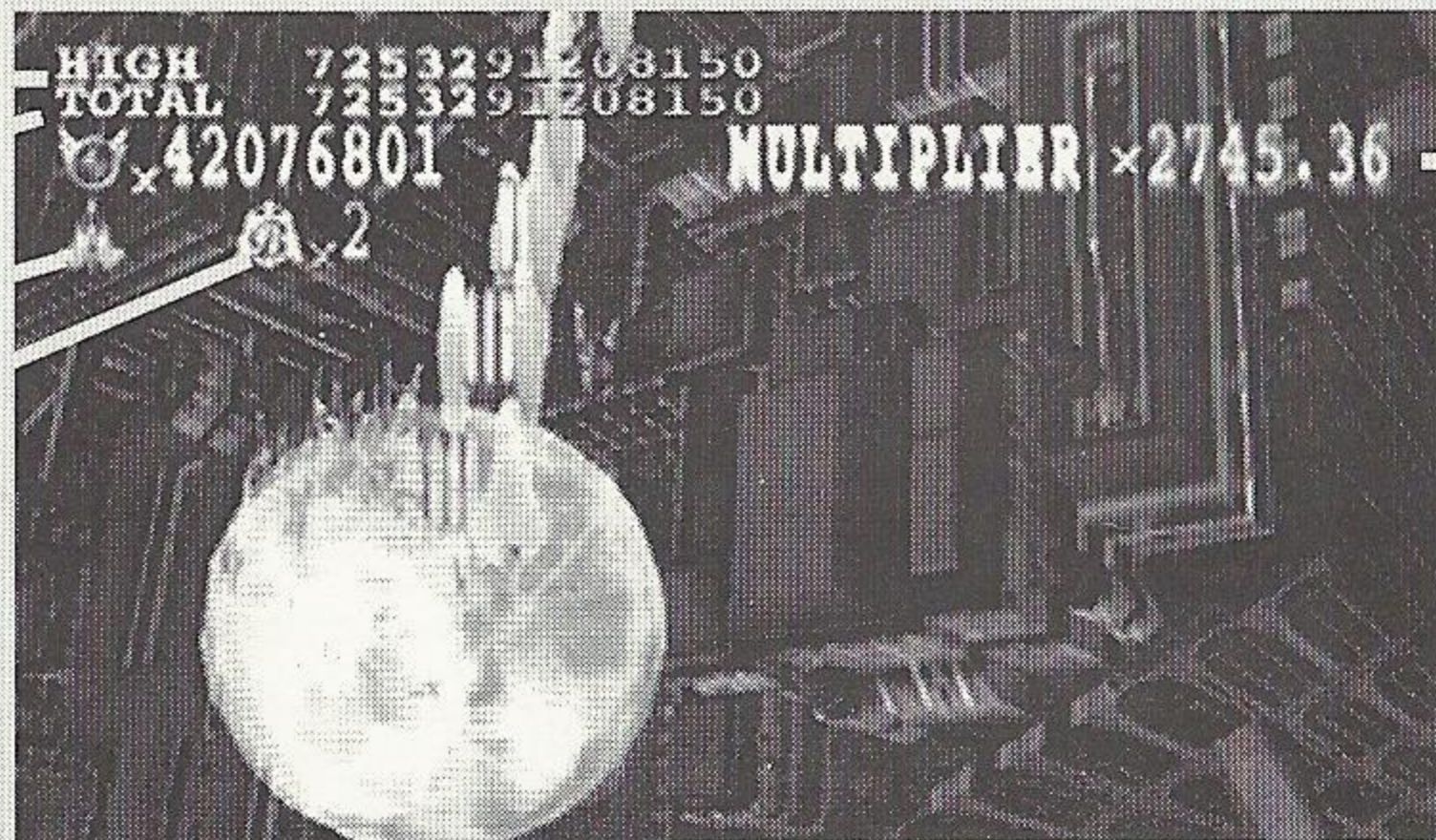

Score
Multiplier

Reflect Gauge



Reflect Gauge
(with OK sign)

- **HIGH SCORE** - The highest score of the game mode.
- **TOTAL SCORE** - Your total score in the game so far.
- **SCORE MULTIPLIER** - (Score Attack Mode only) This increases your score. You can raise the score multiplier by performing special actions during battle.
- **FIGHTERS** - Number of fighters remaining.
- **FORCE BOMB** - Number of Force Bombs available.
- **REFLECT GAUGE** - When the OK sign is displayed, you can use Reflect Force.
- **BOSS BATTLE TIMER** - (Not shown) When the count down reaches zero, the boss will retreat. This is displayed only when you are fighting a boss character.



GIGAWING 2

RULES OF ENGAGEMENT

Control your fighter with the Directional Button, Analog Thumb Pad or Joystick. Evade enemies' attacks, and destroy the enemies with shots, Force Bombs and Reflect Force.

- Your fighter is destroyed when hit by an enemy attack. (It is not injured when it makes contact with an enemy itself.)
- A stage is cleared when you destroy a boss character or the time runs out.
- A game is over when you lose all your fighters or clear Stage 7.

ITEMS

When you destroy certain objects during battle, different items may appear.



POWER-UP - Enhances your fighter's attack up to level 4.

FORCE BOMB - Adds another bomb to your stock of Force Bombs.



SCORE MULTIPLIER ITEM - Increases your score multiplier.

HOW TO ATTACK

NORMAL SHOT - A BUTTON

- Enhance your Normal Shot up to level 4 by collecting power-up items.
- Hold down the X Button or Trigger R (X or Z Button for Arcade Stick) to rapid fire.



FORCE BOMB - B BUTTON

- Use a powerful attack. When you deploy a Force Bomb, all enemy bullets on screen are pulverized and the enemy takes massive damage. Your fighter also becomes invincible for a limited time. You cannot use the Force Bomb when the amount you have drops to zero.



REFLECT FORCE - A BUTTON

- Hold down the A Button (when the OK sign is displayed).
- You can select two different types of Reflect Force:
 - REFLECT BARRIER - Reflect enemies' bullets. The bullets that hit an enemy turn into score multiplier items.
 - REFLECT LASER - Absorb enemies' bullets, then target and fire them all at once.

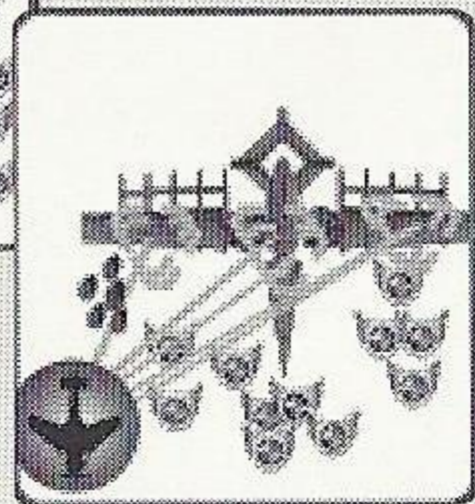
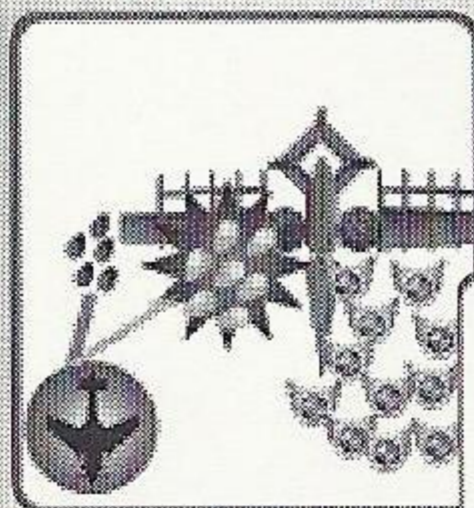

Take advantage of invincibility during Reflect Barrier or Reflect Laser!

GIGAWING 2

GAME MODES

ARCADE MODE

- **NORMAL MODE** - Up to 2 players can play simultaneously. (In 2-player games, a story scene appears between stages.) When 2 players start a game together, their scores and score multipliers are combined.
- **4 PLAYER MODE** - Up to 4 players can play simultaneously. The beginning stage depends on the character you choose. A story scene appears between stages. In multi-player games, the story changes depending on the combination of the characters. The scores and score multipliers of all players are combined.

SCORE ATTACK MODE

Select a stage and try for the highest score possible.

- Choose **SCORE ATTACK** from the Main Menu.
- Choose a stage from the Stage Select screen.
- Choose the number of players, your fighter and Reflect Type.

SCORE ATTACK MODE RULES:

- 1-4 player can play simultaneously with unlimited fighters.
- Your score multiplier increases as long as your fighter stays alive. If your fighter is destroyed or you use a Force Bomb, the score multiplier is reset to zero.
- When you defeat the boss character, your score and results are displayed.
- Score rankings are recorded separately from Arcade Mode scores.

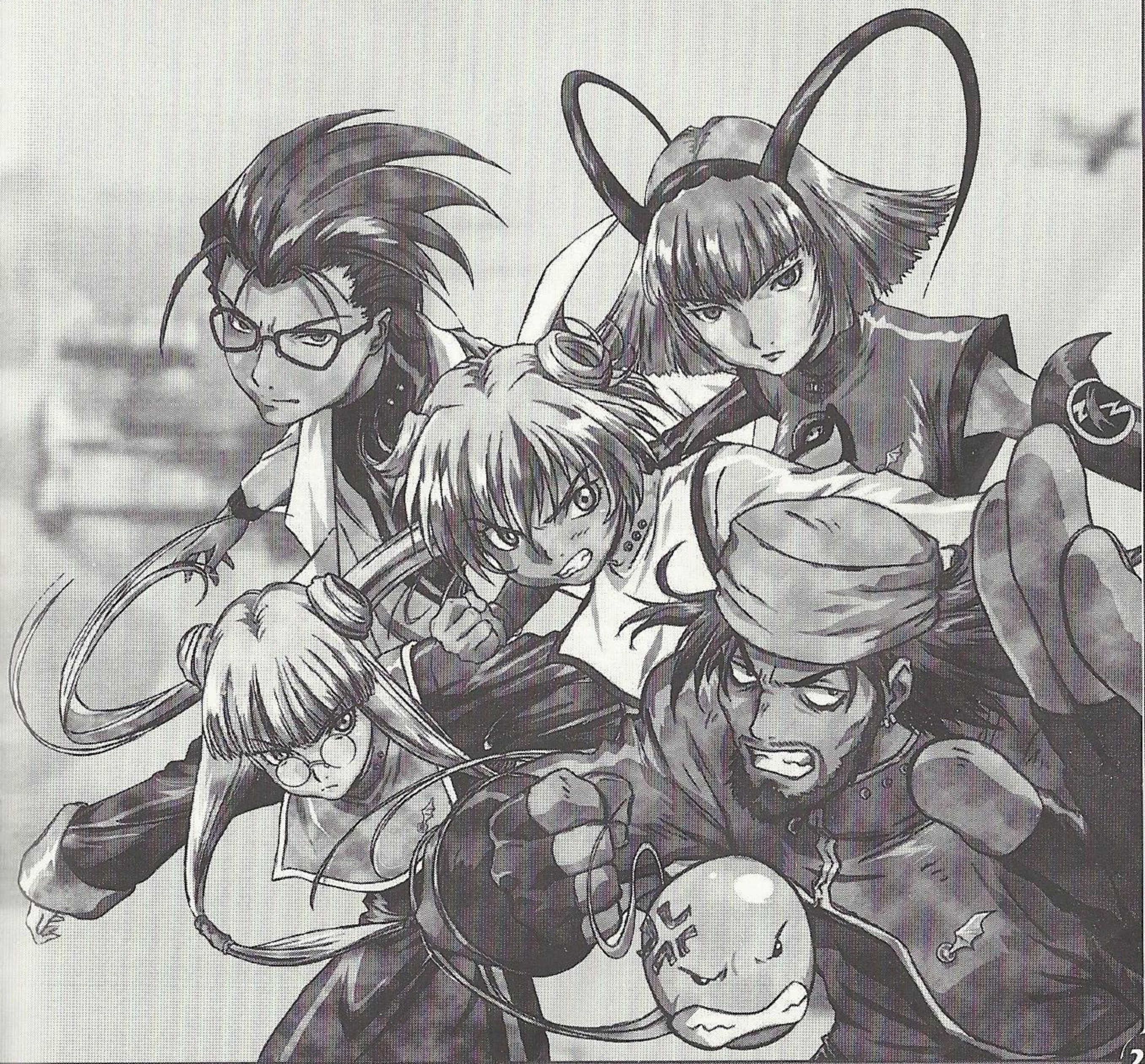

GIGA WING 2

RANKING

Check out the high score rankings of Arcade and Score Attack Modes.

GALLERY

Browse through Giga Wing artwork. Different images will be added as you progress and meet certain game conditions.

OPTION

Set various game options. See page 23.

SAVE & LOAD

Save your game file to a memory card, or load it and resume the game from its saved point.



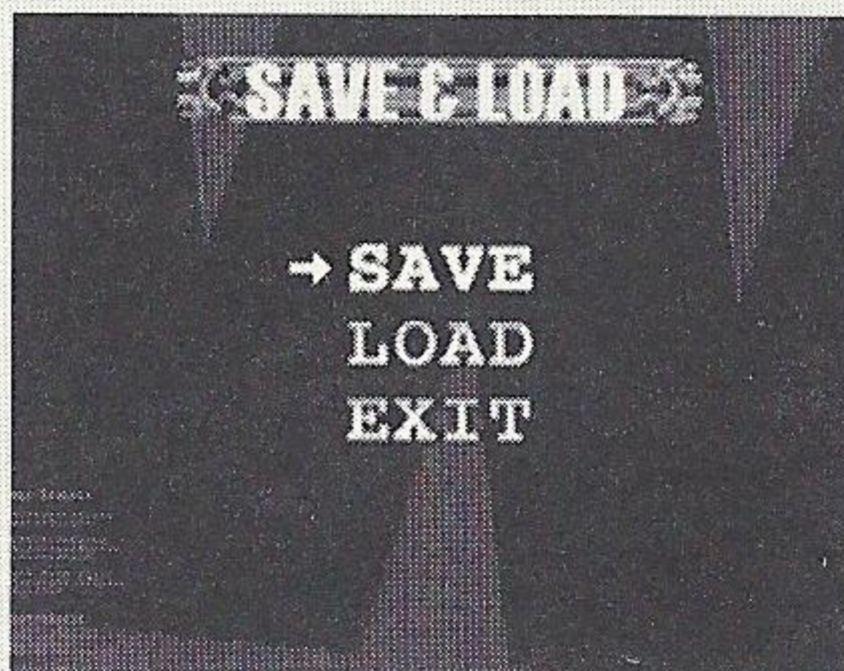
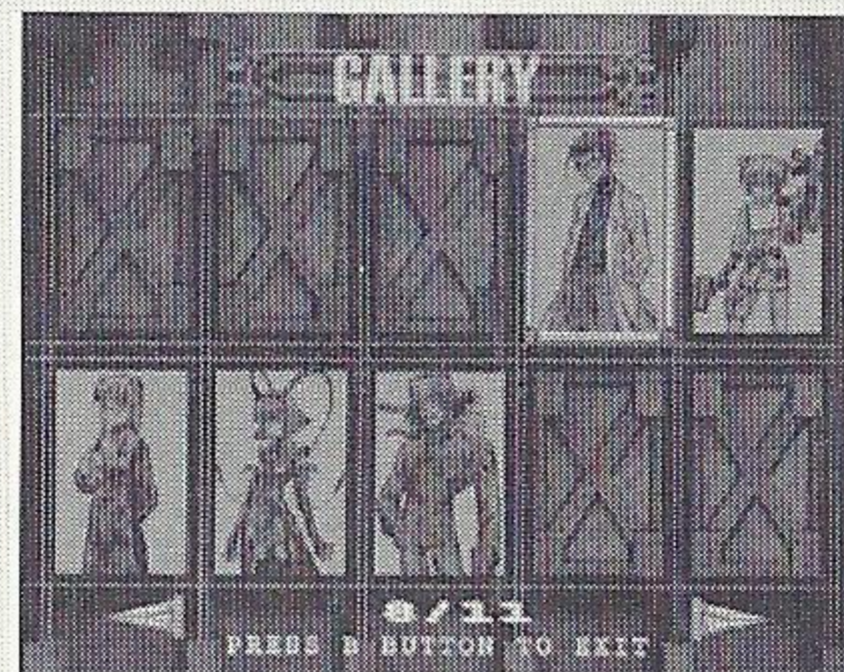
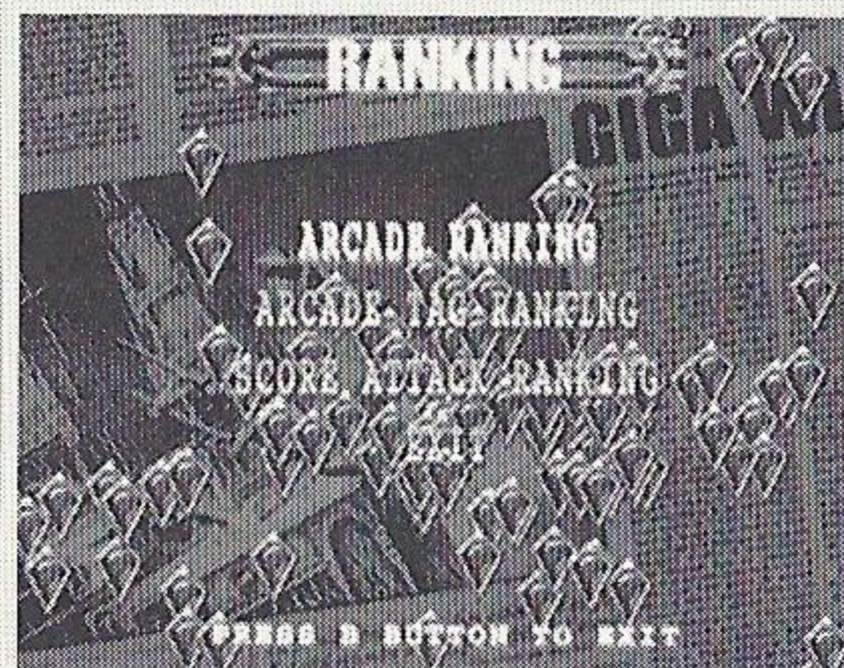

When auto-save is turned ON in Option Mode, game information is saved and loaded automatically.

This game requires 19 free blocks to save game data.

See page 25 for more information.



OPTION MODE

Adjust various game settings. Press the Directional Buttons/Analog Thumb Pad/ Joystick / to choose an option. Press / to change the setting.

- **DIFFICULTY** - Adjust the difficulty level of Arcade Mode from 1 (easiest) to 8 (most difficult). The default is 4.
- **PLAYER STOCK** - Set the starting number of fighters in Arcade Mode from 1 to 9. The default is 3.
- **FORCE BOMB STOCK** - Set the starting number of Force Bombs in Arcade Mode from 0 to 5. The default is 2.
- **AUDIO** - Choose Stereo or monaural to match your speaker setup. The default is **STEREO**.
- **AUTO SAVE** - Turn the auto-save function **ON/OFF**. When **ON**, game information is saved and loaded automatically. The default is **OFF**.
- **SOUND TEST** - Sample game music and sound effects.
- **CONTROLLER SETTING** - Change button assignments and turn the controller vibration **ON/OFF** (when using a Jump Pack).
- **SECRET OPTION** - Secret options will be unlocked as your cumulative score increases.
- **DEFAULT** - Reset all options to their default status.
- **EXIT** - Return to the Main Menu.

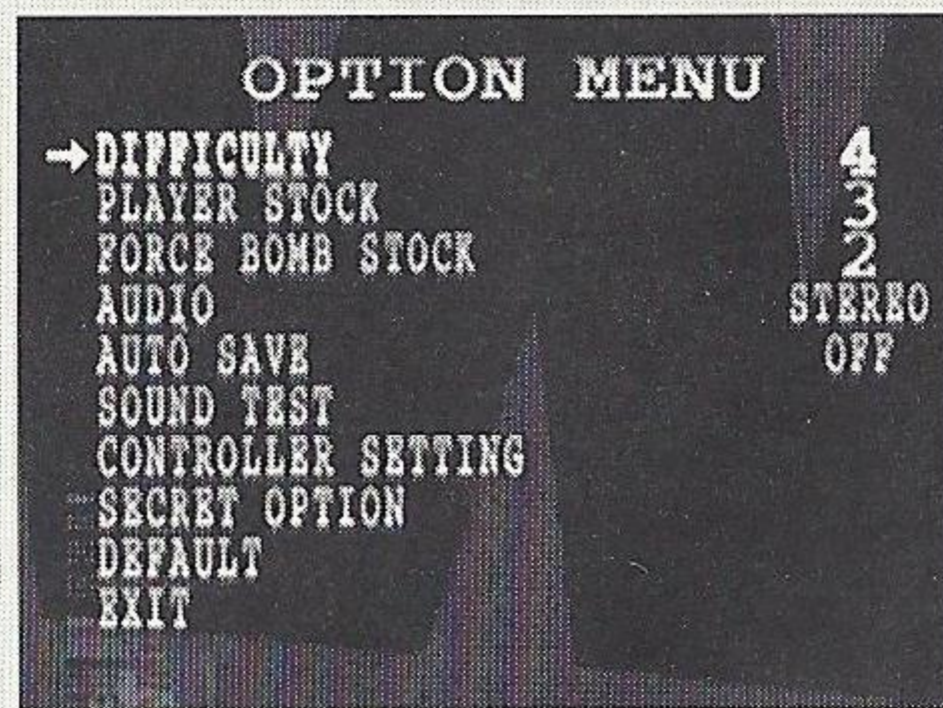

GIGAWING 2

PAUSE MENU

During game play, you can pause with the Start button. The following options are available during pause. To resume your game, press the Start button again or choose CONTINUE from the options.

- **CONTINUE** - Resume your game.
- **RESTART** - Restart the stage from the beginning. All settings are reset to their default status. If you choose this in the Arcade Mode, it is counted as a continue, and your score will not be registered in the Champion Ranking.
- **CONTROLLER SETTING** Change button assignments and turn the controller vibration ON/OFF (when using a Jump Pack).
- **QUIT GAME** - Quit the game and return to the Main Menu.

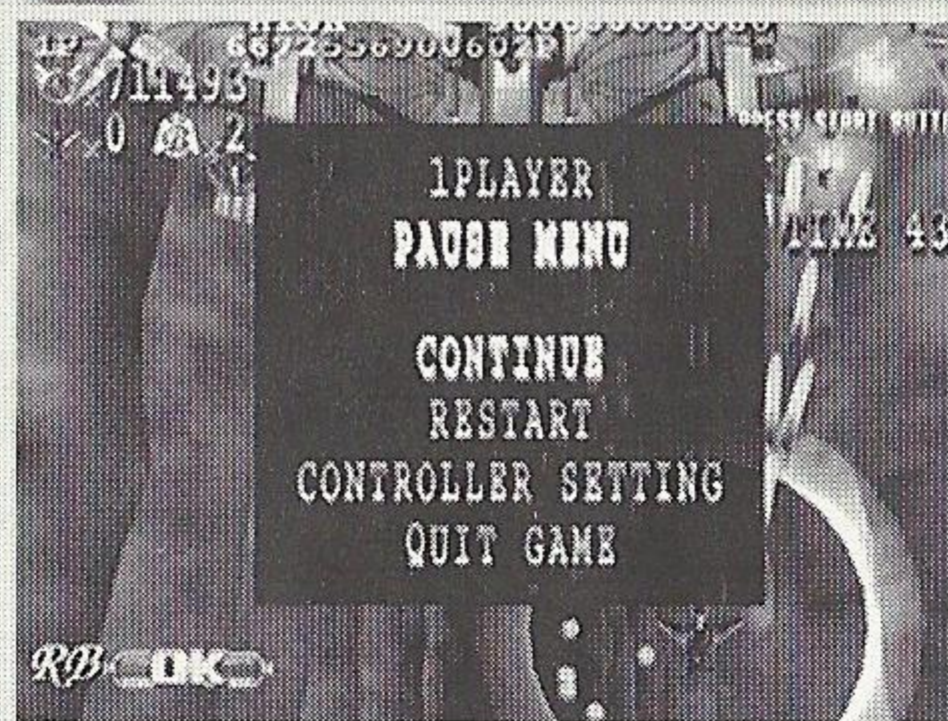

SAVING & LOADING

You can save your game information from Score Ranking Mode, Option Mode and Gallery to a memory card.

SAVE

You can save a game file by using the **SAVE & LOAD** option in Option Mode, or after playing the Arcade or Score Attack Mode. Follow the on-screen messages. When auto-save is on, your game data is saved automatically after playing each game mode.



LOAD

Your previously-saved game file is automatically loaded when you start the game. You can also manually load a game file by selecting **SAVE & LOAD** in Option Mode.

CAUTIONS

- This game requires 19 free blocks to save game data.
- An optional memory card is required to save or load your game data.
- While saving or loading, do not turn off your Sega Dreamcast or remove a memory card or controller.

GIGAWING 2

STAGES



CITY

BOSS: GIMEL. Check the enemy's attack route from the air, wipe out the enemy army and rescue the state capitol.

CLOUD SEA

BOSS: DARET. Destroy the enemy fleet and take command of the air in the metropolitan center.

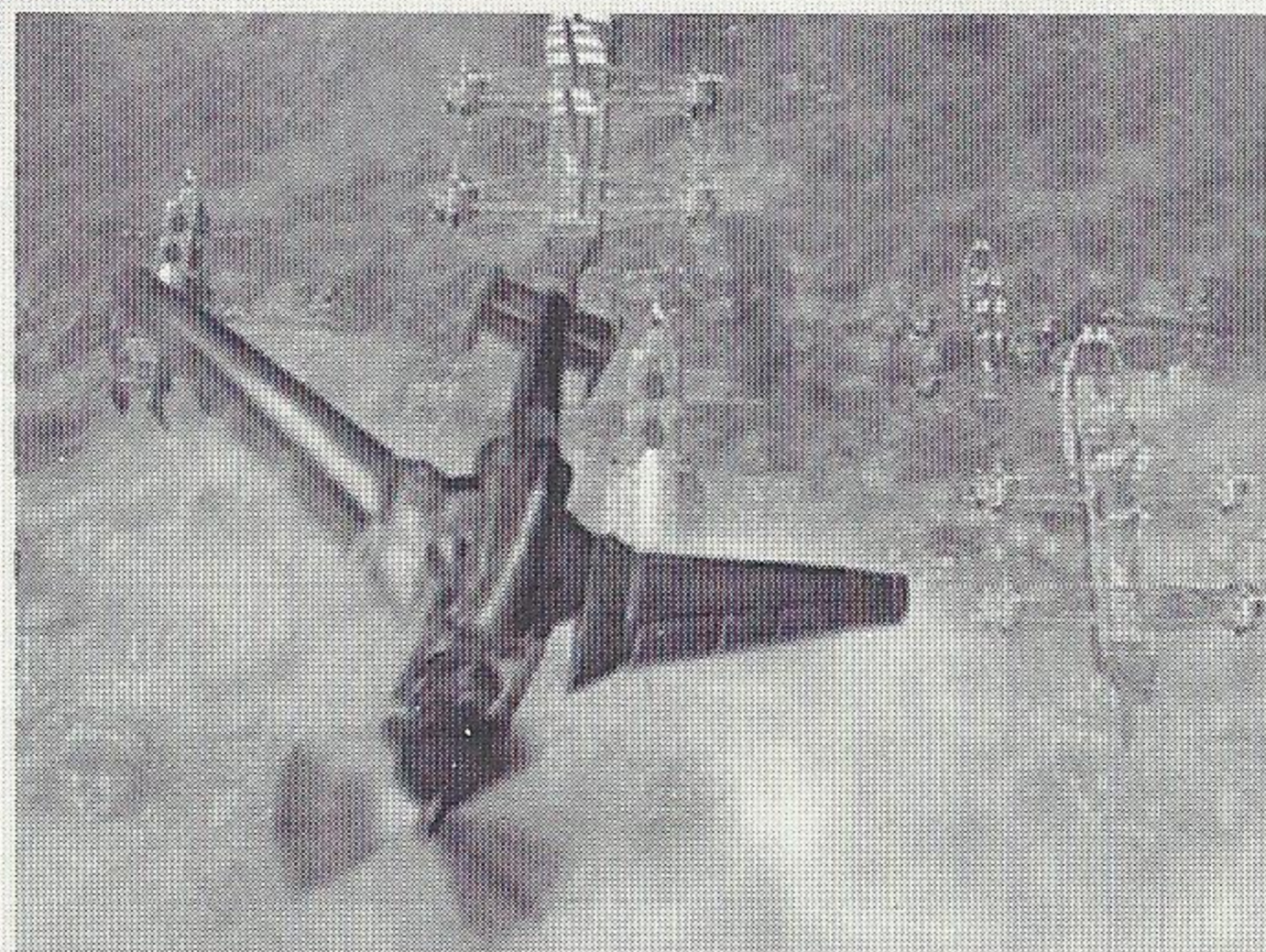

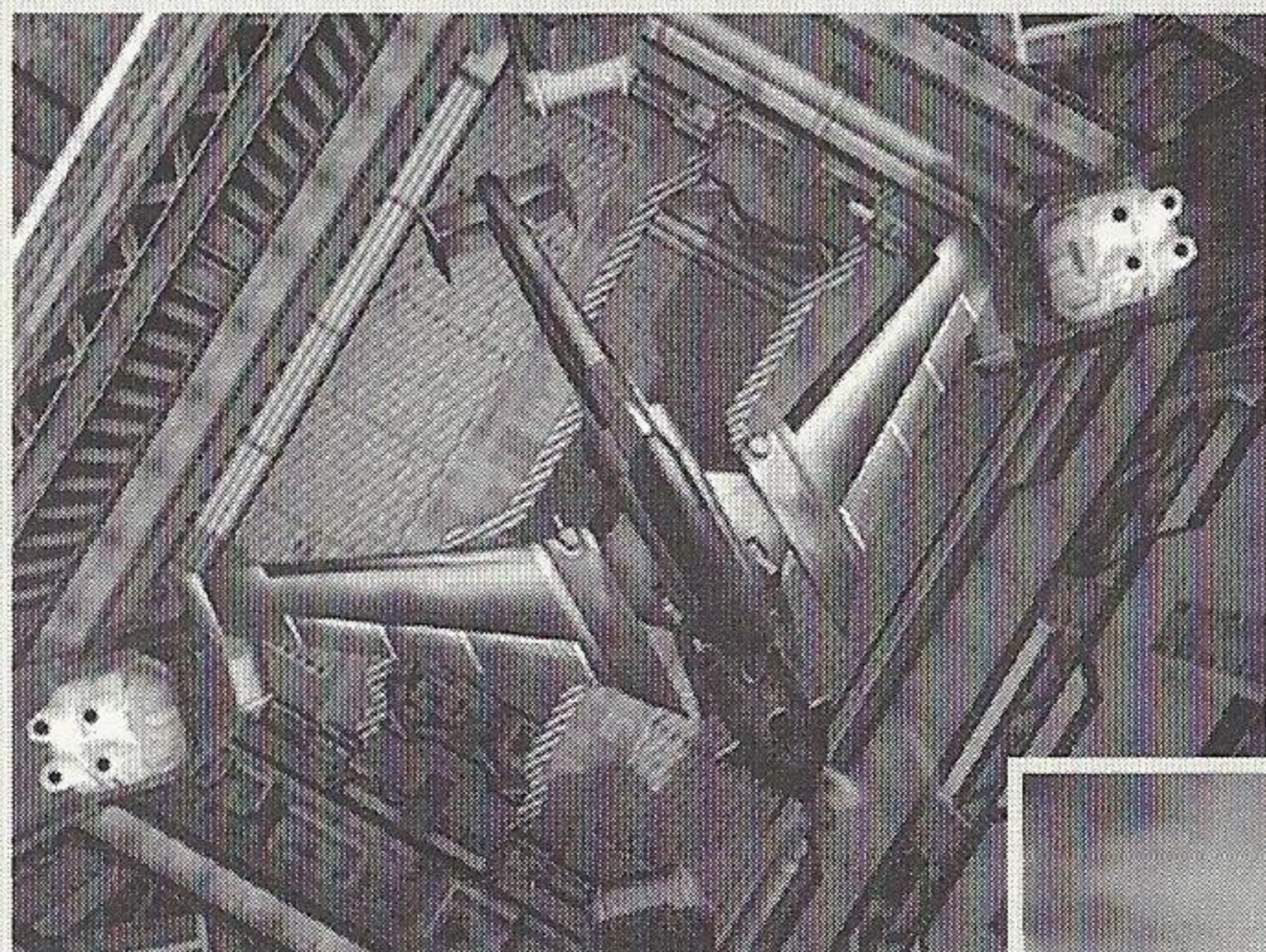

FACTORY

BOSS: YUDD. Break through the enemy's defense line, defeat the enemy in the military factory and destroy a weapon being secretly developed.

SANCTUARY

BOSS: VAVU. The cause of all the battles lies deep in the sanctuary. Giga Wing heads to the forbidden tower located in the center of the sanctuary.



TIP: LOOK FOR THE VOLCANON PHENOMENON!

Volcanon is the key to high score. When a certain number of score multiplier items appear on screen, a Volcanon phenomenon occurs. Now a large number of Score Multipliers appear. Collect as many as you can for super high scores!



TAKE IT TO THE EDGE. CAPCOM EDGE.

COLLECT CAPCOM EDGE PROOF-OF-PURCHASE POINTS EVERY TIME YOU BUY ANY SPECIALLY MARKED CAPCOM GAME TO EARN AMAZING GEAR LIKE SHIRTS, GAMES OR EVEN A PORTABLE CD PLAYER! PLUS, YOU'LL BE ABLE TO WIN QUARTERLY SWEEPSTAKES WITH KILLER PRIZES - LIKE YOUR OWN SIGNATURE SIZE ARCADE MACHINE.

DON'T FIGHT IT! SIGN UP TODAY.

JUST COMPLETE THIS ENTRY FORM OR SEND A 3X5 CARD WITH YOUR NAME, ADDRESS, PHONE NUMBER AND DATE OF BIRTH, AND PARENT'S SIGNATURE (IF UNDER 18) TO:

CAPCOM EDGE 475 OAKMEAD PARKWAY, SUNNYVALE, CA 94085

Offer valid 9/1/99 to 8/31/01. Maximum 2 awards per name and/or address. To claim awards send a completed prize redemption form, Capcom Edge or Fighters Edge proof-of purchase points (or original UPC code) and shipping and handling fees to Capcom Entertainment (see www.capcom.com for complete details). Award merchandise is subject to change and subject to availability while supply lasts. Allow 10-12 weeks for delivery. Items may be shipped separately. Extra points on orders will not be refunded. Points cannot be transferred or sold to another party for use for any other purpose. Capcom Edge points cannot be redeemed for cash. Capcom Entertainment may cancel, rescind or extend this offer at any time. Points are subject to verification. Only original Capcom Edge or Fighters Edge proof of purchase points or original UPC codes are valid from retail packages or from authorized Capcom Edge or Fighters Edge certificates. No reproductions allowed. Points valid only once per game purchase per person. The Capcom Edge program is valid only with current Capcom and Fighters Edge games. Those under age 18 must have parent or guardian signature to participate. The Capcom Edge program is operated by Capcom Entertainment and is open to residents of the United States and Canada excluding Quebec. Fraudulent claims will be voided. Proof of mailing does not constitute proof of delivery. Capcom is not responsible for lost, incomplete, damaged or illegible claim forms. Certified mail is recommended for orders. Sweepstakes winners will be determined in a random drawing from registered Capcom Edge members. No purchase necessary. Odds of winning depend on number of registered Capcom Edge members. Sony Computer Entertainment America, Nintendo of America and Sega of America are in no way affiliated with this program. Employees of Capcom Entertainment, its agencies, vendors and their immediate family members are not eligible for this offer. All decisions of Capcom Entertainment on all matters relating to this promotion are final. Recipients agree that awards are presented on the condition Capcom Entertainment, Sony Computer Entertainment America, Nintendo of America, Sega of America, their affiliates, subsidiaries, divisions or related companies, have no liability whatsoever, for any damages, injuries, losses or expenses of any kind resulting from acceptance, possession or use of the award. Award recipient is responsible for any and all Federal, State and local taxes if necessary. Offer is only good in United States and Canada excluding Quebec. Void where prohibited by law. Other restrictions may apply. All orders must be postmarked by 8/31/01.

© CAPCOM CO., LTD. 2001. © CAPCOM U.S.A., INC. 2001. ALL RIGHTS RESERVED. CAPCOM and the CAPCOM LOGO are registered trademarks of CAPCOM CO., LTD. CAPCOM EDGE is a trademark of CAPCOM CO., LTD.

CAPCOM®

www.capcom.com

NAME

ADDRESS

CITY

STATE

ZIP CODE

PHONE NUMBER

DATE OF BIRTH

PARENT'S SIGNATURE (IF UNDER THE AGE OF 18)

For information on Capcom's Privacy Policy visit: www.capcom.com

GIGA WING 2

CREDITS

Manual Design: Hanshaw Ink & Image; Marketing: Todd Thorson, Sean Mylett Robert Johnson and Nate Williams; Creative Services: Jennifer Deauville and Marion Clifford; Package Design: Michi Morita and Jamie Gibson; Translation: Masayuki Fukumoto; PR: Melinda Mongelluzzo, Matt Atwood and Carrie Root; Special thanks to: Tom Shiraiwa, Miki Takano, Bill Gardner, Robert Lindsey and Customer Service.

90-DAY LIMITED WARRANTY

CAPCOM ENTERTAINMENT, INC. ("CAPCOM") warrants to the original consumer that this Sega Dreamcast GD-ROM ("GD-ROM") from CAPCOM shall be free from defects in material and workmanship for a period of 90 days from date of purchase. If a defect covered by this warranty occurs during this 90-day warranty period, CAPCOM will replace the GD-ROM free of charge.

To receive this warranty service:

1. Notify the CAPCOM Consumer Service Department of the problem requiring warranty service by calling (408) 774-0400. Our Consumer Service Department is in operation from 8:30 a.m. to 5:00 p.m. Pacific Time, Monday through Friday.
2. If the CAPCOM service technician is unable to solve the problem by phone, he/she will instruct you to return the entire GD-ROM to CAPCOM freight prepaid at your own risk of damage or delivery. We recommend sending your GD-ROM certified mail. Please include your sales slip or similar proof-of-purchase within the 90-day warranty period to:

CAPCOM
Consumer Service Department
475 Oakmead Parkway
Sunnyvale, CA 94085

This warranty shall not apply if the GD-ROM has been damaged by negligence, accident, unreasonable use, modification, tampering or by other causes unrelated to the defective materials or workmanship.

REPAIRS AFTER EXPIRATION OF WARRANTY

If the GD-ROM develops a problem after the 90-day warranty period, you may contact the CAPCOM Consumer Service Department at the phone number noted previously. If the CAPCOM service technician is unable to solve the problem by phone, he/she may instruct you to return the defective GD-ROM to CAPCOM freight prepaid at your own risk of damage or delivery, enclosing a check or money for \$20.00 (U.S. funds only) payable to CAPCOM. We recommend sending your GD-ROM certified mail. CAPCOM will replace the GD-ROM, subject to the conditions above. If replacement GD-ROMs are not available, the defective product will be returned to you and the \$20.00 payment refunded.

WARRANTY LIMITATIONS

ANY APPLICABLE IMPLIED WARRANTIES, INCLUDING WARRANTIES OF MERCHANTABILITY AND FITNESS FOR A PARTICULAR PURPOSE, ARE HEREBY LIMITED TO NINETY (90) DAYS FROM THE DATE OF PURCHASE AND ARE SUBJECT TO THE CONDITIONS SET FORTH HEREIN. IN NO EVENT SHALL CAPCOM BE LIABLE FOR CONSEQUENTIAL

GIGA WING 2

10 PTS.



GIGA WING 2

10 PTS.

OR INCIDENTAL DAMAGES RESULTING FROM THE BREACH OF ANY EXPRESS OR IMPLIED WARRANTIES.

The provisions of this warranty are valid in the United States and Canada only. Some states and provinces do not allow limitations on how long an implied warranty lasts or exclusions of consequential or incidental damages, so the above limitations and exclusions may not apply to you. This warranty gives you specific legal rights, and you may have other rights, which vary, from state to state or province to province.

ESRB RATING

This product has been rated by the Entertainment Software Rating board. For information about the ESRB rating, or to comment about the appropriateness of the rating, please contact the ESRB at 1-800-771-3772.

Sega is registered in the US Patent and Trademark Office. Sega, Dreamcast and the Dreamcast logo are either registered trademarks or trademarks of Sega Corp. All Rights Reserved. Made and printed in the USA. WARNING: Operates only with NTSC televisions and Sega Dreamcast systems purchased in North and South America (except Argentina, Paraguay and Uruguay). Will not operate with any other televisions or Sega Dreamcast systems. Product covered under one or more of the following U.S. Patents: 5,460,374; 5,525,770; 5,627,895; 5,688,173; 4,442,486, 4,454,594; 4,462,076; Re. 35,839; Japanese Patent No. 2870538, (Patents pending in U.S. and other countries); Canada Patent No. 1,183,276. The ratings icon is a trademark of the Interactive Digital Software Association. Sega of America Dreamcast, Inc, P.O. Box 7639, San Francisco, CA 94120.

SEGA



GIGA WING 2

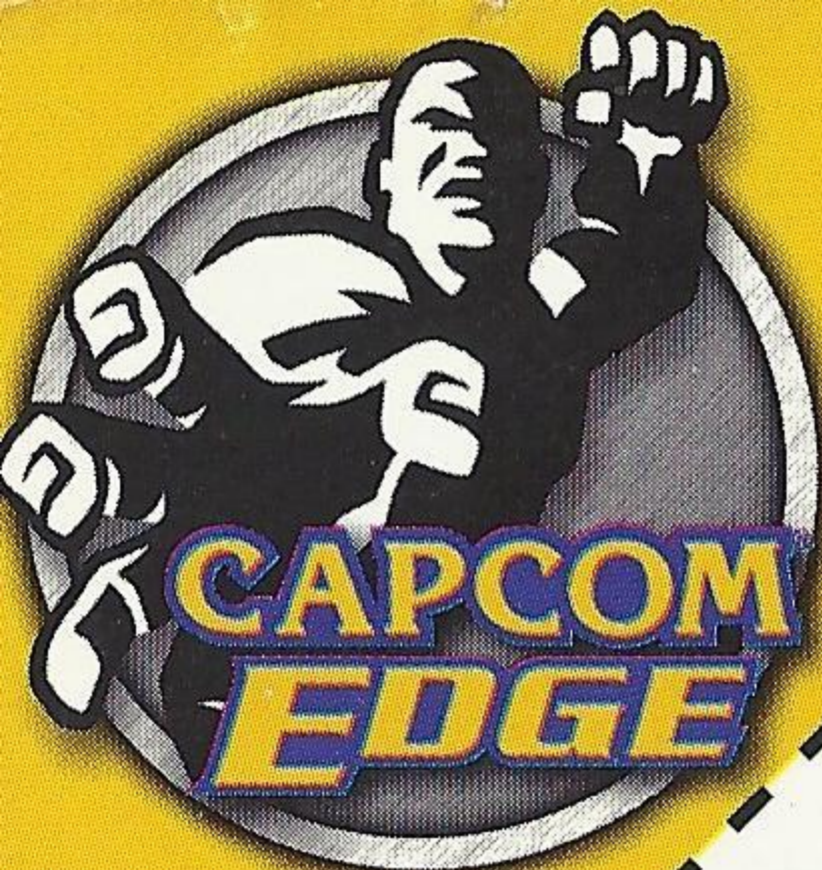

GIGA WING 2

10 PTS.



GIGA WING 2

10 PTS.

TAKE IT TO THE EDGE CAPCOM EDGE

JOIN THE RANKS OF THE WORLD'S GAMING ELITE AND EARN CAPCOM EDGE POINTS EVERY TIME YOU BUY THE CAPCOM GAMES YOU LOVE. COLLECT MORE POINTS AND GET ALL KINDS OF COOL STUFF LIKE T-SHIRTS, WATCHES, SUNGLASSES PORTABLE STEREOS AND OTHER CAPCOM EDGE GEAR DON'T FIGHT IT! JOIN TODAY!

Capcom Entertainment, Inc. 475 Oakmead Parkway Sunnyvale, CA 94086

© CAPCOM CO., LTD. 2001 © CAPCOM U.S.A., INC. 2001. ALL RIGHTS RESERVED. CAPCOM and the CAPCOM LOGO are registered trademarks of CAPCOM CO., LTD. GIGA WING and CAPCOM EDGE are trademarks of CAPCOM CO., LTD.

Sega is registered in the US Patent and Trademark Office. Sega, Dreamcast and the Dreamcast logo are either registered trademarks or trademarks of Sega Corporation. All Rights Reserved. Made and printed in the USA.

WARNING: Operates only with NTSC televisions and Sega Dreamcast systems purchased in North and South America (except Argentina, Paraguay and Uruguay). Will not operate with any other televisions or Sega Dreamcast systems.

Product covered under one or more of the following U.S. Patents: 5,460,374; 5,525,770; 5,627,895; 5,688,173; 4,442,486; 4,454,594; 4,462,076; Re. 35,839; Japanese Patent No.2870538, (Patents pending in U.S. and other countries);

Canada Patent No. 1,183,276. The ratings icon is a registered trademark of the Interactive Digital Software Association. Sega of America Dreamcast, Inc, P.O. Box 7639, San Francisco, CA 94120.

CAPCOM

SEGA